



Floor Coverings • Zemin Kaplamaları • Напольные покрытия



**net**  
FLOOR COVERINGS  
[www.netfloor.com.tr](http://www.netfloor.com.tr)

Sayfa / Page Страница <b>14 - 19</b>	<b>Hipokrat</b>	<b>EcoPrint</b>	Sayfa / Page Страница <b>114 - 121</b>
Sayfa / Page Страница <b>20 - 33</b>	<b>netflex</b>	<b>ОТОКАР EMBOSS</b>	Sayfa / Page Страница <b>122 - 133</b>
Sayfa / Page Страница <b>34 - 40</b>	<b>[N-LVT]</b>	<b>ОТОКАР EXTRA SOFT</b>	Sayfa / Page Страница <b>134 - 145</b>
Sayfa / Page Страница <b>41 - 45</b>	<b>SafeFlex</b>	<b>ОТОКАР EXTRA STRONG</b>	Sayfa / Page Страница <b>146 - 157</b>
Sayfa / Page Страница <b>46 - 53</b>	<b>DigiKap</b>	<b>ЕКОКАР</b>	Sayfa / Page Страница <b>158 - 168</b>
Sayfa / Page Страница <b>54 - 66</b>	<b>HomeFlex</b>	<b>PopFlex</b>	Sayfa / Page Страница <b>169 - 174</b>
Sayfa / Page Страница <b>67 - 77</b>	<b>YERKOP</b>	<b>PopFlex Lite</b>	Sayfa / Page Страница <b>175 - 180</b>
Sayfa / Page Страница <b>78 - 89</b>	<b>EcoFlex</b>	<b>PopFlex Ultra</b>	Sayfa / Page Страница <b>181 - 186</b>
Sayfa / Page Страница <b>90 - 97</b>	<b>EVKAP</b>	<b>PopFlex Extra</b>	Sayfa / Page Страница <b>187 - 192</b>
Sayfa / Page Страница <b>98 - 106</b>	<b>BUSKAP</b>	<b>PROKOP</b>	Sayfa / Page Страница <b>193 - 197</b>
Sayfa / Page Страница <b>107 - 113</b>	<b>ОТОКАР PRINT</b>	<b>net finishing profiles</b>	Sayfa / Page Страница <b>200 - 221</b>





Schools

Okullar

школы



Dormitories

Yatakhaneler

общежития



Hospitals

Hastaneler

больницы



Light Commercial Facilities

Hafif Sanayi Tesisleri

торговые объекты



Commercial Areas

Ticaret Merkezleri

коммерческие зоны



Offices

Ofisler

офисы



Ready Structures

Hazır Yapılar

Готовые конструкции



Raised Floor

Yükseltilmiş Döşeme

Поднятый Этаж



Containers

Yaşam Konteynerleri

Зоны стоянки



Camping Areas

Kamp Sahaları

контейнеров



Buses

Otobüs

Автобусы,



Passenger Cars

Binek Araç

пассажирские вагоны



Commercial Vehicles

Ticari Araçlar

Коммерческие автомобили



Elevators

Asansörler

Лифты



Hotels

Oteller

Отели



Offices

Ofisler

офисы



**Net Floor Coverings is a manufacturer of thermoplastic-based heterogeneous floor coverings for commercial use.**

- Established in 1992 with 100% Turkish capital.
- A boutique flexible flooring manufacturer that mainly offers flooring solutions for different business areas, primarily the construction, hardware, automotive and cabin manufacturing sectors.
- Has a final product capacity of 4,000,000 m<sup>2</sup>/year.
- Specialized in PVC-based commercial floor coverings.
- Has experience and knowledge in the field of calendaring PVC and non-PVC thermoplastic based sheets.
- Tends to have visual, dimensional and functional diversity in all product groups.
- Takes valid national and international norms as basis for its production processes and products.
- Exports to Middle East, Balkans, the Caucasus, Central Asia, Africa, and Europe.
- Has the ability to design and manufacture products beyond standard products for its customers.
- Produces 100% recyclable products.

### **Production:**

We manufacture long-lasting products using 100% suspension PVC with high mechanical strength in our products. We produce with extrusion technology based on the use of high pressure and heat, which allows us to shape the chemical properties of PVC at the highest level. With the calendaring technology we use in our production, we process the physical properties of PVC in the most flexible way and we can manufacture T-Group flexible floor coverings.

### **Customer Profile:**

Our commercial floor coverings are used and marketed in many commercial areas by both industrial companies and merchant companies. Construction, automotive, container, prefabricated building, elevator, raised auto flooring and hardware sectors are among our main customers in our flooring business. Our markets are used in the countries of the Caucasus, Eastern and Central Europe, Central Asia, the Middle East, and North and Central Africa.

### **Usage Areas :**

Our products have been used for many years in schools, dormitories, hospitals, light industry facilities, trade centers, offices, buses, living containers, campsites, trains, wagons, and light rail passenger vehicles, as well as elevators, warehouses, system rooms, and ready-made structures for many years.

**Net Floor Coverings; Termoplastik esaslı ticari kullanıma dönük heterojen zemin kaplamaları üreticisidir.**

- 1992'de %100 Türk sermayesi ile kurulmuştur.
- Başta, İnşaat, nalburiye, otomotiv ve kabin imalat sektörleri olmak üzere farklı iş sahalarına dönük ağırlıklı olarak zemin kaplaması çözümleri sunan butik bir esnek zemin kaplaması üreticisidir.
- 4.000.000 m<sup>2</sup>/yıl'lık nihai ürün kapasitesine sahiptir.
- PVC esaslı ticari zemin kaplamaları alanında ihtisas sahibidir.
- Hem PVC hem de PVC-dışı termoplastiklerin kalenderlenmesi alanında tecrübe ve bilgi sahibidir.
- Tüm ürün gruplarında görsel, boyutsal, fonksiyonel çeşitlilik sahibi olma eğilimindedir
- Geçerli ulusal ve uluslararası normları üretim süreçleri ve ürünleri için esas kabul eder.
- Ortadoğu, Balkanlar, Kafkasya, Orta Asya, Afrika, Avrupa bölgelerinde ihracat gerçekleştirmektedir.
- Müşterileri için standart ürünlerin ötesinde ürün tasarlama ve imal etme yeterliliğine haizdir.
- %100 geri dönüşümlü ürünler üretir.

### **Üretim :**

Ürünlerimizde mekanik mukavemeti yüksek %100 süspansiyon PVC kullanarak uzun ömürlü ürünler imal ederiz. PVC'nin kimyasal özelliklerini en yüksek seviyede şekillendirmemize olanak sağlayan, yüksek basınç ve ısı kullanımı esasındaki ekstrüzyon teknolojisi ile üretim yapıyoruz. Üretimimizde kullandığımız kalenderleme teknolojisi ile PVC'nin fiziksel özelliklerini en esnek biçimde işliyor ve T-Grubu esnek zemin kaplamaları imal edebiliyoruz.

### **Müşteri Profilimiz :**

Ticari zemin kaplamalarımız gerek sanayi şirketleri gerekse tacir firmalar tarafından pek çok ticari alanda kullanılmakta ve pazarlanmaktadır. İnşaat, otomotiv, konteyner, hazır yapı, asansör, yükseltilmiş oto döşeme ve nalburiye sektörleri zemin kaplama isimizdeki ana müşterilerimiz arasındadır. Pazarlarımız, Kafkasya, Doğu ve Orta Avrupa, Orta Asya, Orta Doğu, Kuzey ve Merkez Afrika ülkelerinde kullanılmaktadır.

### **Kullanım Alanları :**

Ürünlerimiz okullarda, yatakhanelerde, hastanelerde, hafif sanayi tesislerinde, ticaret merkezlerinde, ofislerde, otobüslerde, yaşam konteynerlerinde, kamp sahalılarında, tren, vagon ve hafif raylı yolcu araçları ile asansörlerde, depolarda, sistem odalarında ve hazır yapılarda uzun yıllardır kullanılmaktadır.



**Net Floor Coverings - это производитель гетерогенных напольных покрытий для коммерческого использования на основе термопластов.**

- Компания основана в 1992 году и состоит из 100% Турецкого капитала.
- Компания является немассовым производителем гибких напольных покрытий, который в основном предлагает решения для напольных покрытий для различных сфер бизнеса, прежде всего для строительства, скобяных изделий, автомобилестроения и производства кабин.
- Производительность компании по выпуску конечной продукции составляет 4 000 000 м2/год.
- Специализируется на коммерческих напольных покрытиях на основе ПВХ.
- Имеет богатый опыт и знания в области каландрирования термопластичных листов из поливинилхлорида и других материалов.
- Имеет тенденцию к визуальному, размерному и функциональному разнообразию во всех группах продуктов.
- Держит за основу действующие национальные и международные нормы для производственных процессов и продуктов.
- Осуществляет экспортную торговлю в такие регионы как Ближний Восток, Балканы, Кавказ, Средняя Азия, Африка и Европа.
- Компания имеет возможность разрабатывать и изготавливать для своих клиентов продукты, выходящие за рамки стандартных продуктов.
- Производит на 100% перерабатываемые продукты.

**Производство:**

Мы производим долговечные изделия, используя в своем производстве 100% суспензионный ПВХ, обладающий высокой механической прочностью. В нашем производстве мы используем экструзионную технологию, основанную на применении высокого давления и тепла, что позволяет формировать химические свойства ПВХ на самом высоком уровне. Благодаря технологии каландрирования, которая применяется в нашем производстве, физические свойства ПВХ обрабатываются наиболее гибким способом, что дает нам возможность производить гибкие напольные покрытия группы Т.

**Профиль клиента:**

Наши коммерческие напольные покрытия используются и продаются во многих коммерческих сферах, как промышленными компаниями, так и торговыми компаниями. Отрасли строительства, автомобилестроения, производители контейнеров, сборных домов, лифтов, скобяных изделий и фальшполы для автомобилей являются нашими главными клиентами в бизнесе по производству напольных покрытий. Наша продукция используется в странах Кавказа, Восточной и Центральной Европы, Средней Азии, Ближнего Востока, Северной и Центральной Африки.

**Области применения:**

Наша продукция используется и служит долгие годы в школах, общежитиях, больницах, предприятиях легкой промышленности, торговых центрах, офисах, автобусах, жилых контейнерах, турбазах, поездах, вагонах и легкорельсовом транспорте, лифтах, складах, системных помещениях и готовых конструкциях.

Standard Ranges											
	General Covering		Residential		Light Commercial		Heavy Commercial		Safety		
	Virgin	Recycle*	Virgin	Recycle*	Virgin	Recycle*	Virgin	Recycle*	Virgin	Recycle*	
<b>Roll</b>	EcoKar, PopFlex	EcoKar, PopFlex	HomeFlex	PopFlex, YerKar, Otokar Emboss	NetFlex, NetFlex, Hipokrat, Digikar	EcoFlex, YerKar, EwKar, Otokar Print	NetFlex, NetFlex, Hipokrat, Digikar	EcoFlex, YerKar	SafeFlex, BusKap	Otokar Print	Otokar Emboss, Otokar Print, Otokar Extra Soft, Otokar Extra Strong, EwKar, PopFlex Extra
<b>Tile</b>					N-LVT						BusKap
											BusKap, ProKap
											BusKap, ProKap
											BusKap, ProKap

\* Standard versions contain Recycled PVC Content (No warrant and declaration for chemical ingredients and chemical behaviors).  
 \* All Recycled versions can be manufactured with virgin PVC content (Chemical content and chemical behaviors can be declared).

Standart Ürün Grupları											
	Genel Kaplama		Yerleşim		Hafif Ticari		Ağır Ticari		Emniyet		
	Orjinal PVC	Gerit Dönüştürülmüş PVC	Orjinal PVC	Gerit Dönüştürülmüş PVC	Orjinal PVC	Gerit Dönüştürülmüş PVC	Orjinal PVC	Gerit Dönüştürülmüş PVC	Orjinal PVC	Gerit Dönüştürülmüş PVC	
<b>Rulo</b>	EcoKar, PopFlex	EcoKar, PopFlex	HomeFlex	PopFlex, YerKar, Otokar Emboss	NetFlex, NetFlex, Hipokrat, Digikar	EcoFlex, YerKar, EwKar, Otokar Print	NetFlex, NetFlex, Hipokrat, Digikar	EcoFlex, YerKar	SafeFlex, BusKap	Otokar Print	Otokar Emboss, Otokar Print, Otokar Extra Soft, Otokar Extra Strong, EwKar, PopFlex Extra
<b>Karo</b>					N-LVT						BusKap
											BusKap, ProKap
											BusKap, ProKap
											BusKap, ProKap

\* Standart versiyonlar Gerit Dönüştürülmüş PVC İçeriği İçerir (Kimyasal İçerik ve kimyasal davranışlar için garanti ve beyan yoktur).  
 \* Tüm Gerit Dönüştürülmüş versiyonları orjinal PVC içeriği ile üretilebilir (Kimyasal İçerik ve kimyasal davranışlar beyan edilebilir).

Стандартные Диапазоны											
	Общее Покрытие		Жилой		Легкий Коммерческий		Тяжелый Коммерческий		Безопасность		
	Необработанный	Переработка*	Необработанный	Переработка*	Необработанный	Переработка*	Необработанный	Переработка*	Необработанный	Переработка*	
<b>Рулон</b>	EcoKar, PopFlex	EcoKar, PopFlex	HomeFlex	PopFlex, YerKar, Otokar Emboss	NetFlex, NetFlex, Hipokrat, Digikar	EcoFlex, YerKar, EwKar, Otokar Print	NetFlex, NetFlex, Hipokrat, Digikar	EcoFlex, YerKar	SafeFlex, BusKap	Otokar Print	Otokar Emboss, Otokar Print, Otokar Extra Soft, Otokar Extra Strong, EwKar, PopFlex Extra
<b>Плитка</b>					N-LVT						BusKap
											BusKap, ProKap
											BusKap, ProKap
											BusKap, ProKap

\*Стандартные версии содержат переработанный ПВХ (Отсутствие гарантий и заявлений о химических ингредиентах и свойствах).  
 \*Все переработанные версии могут быть изготовлены с содержанием первичного ПВХ (могут иметься заявления о химических ингредиентах и свойствах).

<b>Hipokrat</b>	Compact Heterogeneous Vinyl Floor Coverings	Kompakt Heterojen Vinil Zemin Kaplamaları	Компактный гетерогенный винил HanonbHble noKpbITИ/ИH
<b>netflex</b>	Multi-Layered Compact Vinyl Flooring	Çok Katmanlı Kompakt Vinil Döşeme	Многослойный Компактный виниловый пол
<b>[N-LVT]</b>	Heterogeneous Commercial Floor Coverings	Heterojen Ticari Zemin Kaplamaları	Гетерогенная коммерческая HanonbHble noKpbITИ/ИH
<b>SafeFlex</b>	Vinyl Solutions for Wet Floors	Islak Zeminler İçin Vinil Çözümler	Виниловые решения для Мокрые полы
<b>DigiKap</b>	Coverings With Digital Printed Images	Dijital Baskılı Kaplamalar	покрытия с цифровой печатью
<b>HomeFlex</b>	Multi-Layered Compact Vinyl Flooring	Çok Katmanlı Kompakt Vinil Zemin Kaplamaları	Многослойный Компактный виниловый пол
<b>YERIKOP</b>	Heterogeneous Commercial Floor Coverings	Heterojen Ticari Zemin Kaplamaları	Гетерогенная коммерческая HanonbHble noKpbITИ/ИH
<b>EcoFlex</b>	Multi-layered Compact Vinyl Flooring	Çok Katmanlı Kompakt Vinil Zemin Kaplamaları	Многослойный компактный виниловый пол
<b>EVKap</b>	Domestic Coverings	Evsel Mekan Kaplamaları	Покрытия бытового назначения
<b>BUSKap</b>	Transport Safety Flooring	Araç İçİ Güvenlikli Zemin Kaplamaları	Транспортная безопасность Напольное покрытие
<b>OTOKAP PRINT</b>	Printed Transport Floor Coverings	Araç İçİ Baskılı Kaplamaları	Автомобильные узорные напольные покрытия

<b>EcoPrint</b>	Floor Coverings For Portable Cabines	Seyyar Yaşam Alanları İçin Zemin Kaplaması	Портативные жилые помещения Напольные покрытия
<b>OTOKAP EMBOSS</b>	Transport Floor Coverings	Araç İçİ Zemin Kaplamaları	Автомобильные HanonbHble noKpbITИ/ИH
<b>OTOKAP EXTRA SOFT</b>	Transport Floor Coverings	Araç İçİ Zemin Kaplamaları	Автомобильные HanonbHble noKpbITИ/ИH
<b>OTOKAP EXTRA STRONG</b>	Transport Floor Coverings	Araç İçİ Zemin Kaplamaları	Автомобильные HanonbHble noKpbITИ/ИH
<b>ECOKAP</b>	General Purpose Floor Coverings	Genel Amaçlı Zemin Kaplamaları	Покрытия общего HanonbHble noKpbITИ/ИH
<b>PopFlex</b>	Multi-Layered Compact Vinyl Flooring	Çok Katmanlı Kompakt Vinil Döşeme	Многослойный Компактный виниловый пол
<b>PopFlex Lite</b>	Economic Heterogeneous Contract Floor Coverings	Ekonomik Heterojen Kontrat Zemin Kaplamaları	Экономичный KoHTpaKTHble rereporeHHble HanonbHble noKpbITИ/ИH
<b>PopFlex Ultra</b>	Multi-Layered Compact Vinyl Flooring	Çok Katmanlı Kompakt Vinil Zemin Kaplamaları	Многослойный компактный виниловый пол
<b>PopFlex Extra</b>	Multi-Layered Compact Vinyl Flooring	Çok Katmanlı Kompakt Vinil Zemin Kaplamaları	Многослойный компактный виниловый пол
<b>PROKAP</b>	Profesyonel Zemin Kaplamaları	Professional Floor Coverings	Профессиональные напольные изделия
<b>net finishing profiles</b>	Finishing Profiles For Resilient Floor Coverings	Esnek Zemin Kaplamaları İçin Bitirme Profilleri	Отделочные профили для Эластичные напольные покрытия





Hipokrat

Compact Heterogeneous Vinyl  
Floor Coverings

Kompakt Heterojen Vinil  
Zemin Kaplamaları

Компактный гетерогенный винил  
HanonbHble noKpbITI/IH

# Hipokrat



**For Health Facilities**

Sağlık Tesisleri İçin

Для медицинских учреждений

**net**  
FLOOR COVERINGS

[www.netfloor.com.tr](http://www.netfloor.com.tr)



## Heterogeneous Contract Floor Coverings



## Heterojen Kontrat Zemin Kaplamaları



## КоНТраКТННble rereporeННble HanonbHble noKpbITИ/ИH



• NetFloor Hipokrat is the specialized member of the product family for healthcare facilities. Hipokrat particles, produced with almost no filling, bind to each other with the maximum bond strength and thus offer exceptional resistance to impact and traffic.

• Hipokrat complies with the technical specifications stated in the 2018 Revision of the Ministry of Health's General Directorate of Health Investments, Survey Project Real Estate Department's Circular no. 1672, Minimum Mandatory Technical Standards in Existing and New Healthcare Facilities.

• Hipokrat, which is in the Group-T wear group, offers a long-lasting use in heavy traffic areas with its calendared compact structure with a Type-I binder ratio.

• Hipokrat conforms to Y.25.116/A05.

• Hipokrat, which is reinforced with the polyurethane-based PURGuard surface protection system, does not clearly show dust and dirt traces and can be easily cleaned. PURGuard technology adheres perfectly to the calendared wear layer, providing a shield against scratches.

• Thanks to its special formula that does not contain any fillers, it is approximately 5% lighter than standard Hipokrat products to reduce the static load in healthcare facilities.

• With its non-water absorbing, foamed, expanded foam, cork, and textile-free structure, Hipokrat is a hygienic product that is suitable for sterilization with chemicals with the right flooring practices and is prone to wet cleaning.

• Hipokrat is a 100% traceable product produced using only virgin PVC. All chemicals used in it are traceable in terms of compliance with applicable chemical regulations.

• With its glass fiber reinforcement, Hipokrat is qualified to maximize hygiene and cleaning performance in healthcare facilities in the coldest and hottest geographies.

• Hipokrat will help you reduce your carbon footprint with its 100% recyclable and reusable structure.

• With its matte appearance and 13 pastel color variants, it offers a sufficient base for architectural solutions in search of a particularly simple and calm atmosphere.

• Hipokrat ürün ailesinin sağlık tesislerine dönük özelleşmiş üyesidir. Neredeyse dolgusuz olarak üretilen Hipokrat partikülleri maksimum bağ kuvvetiyle birbirine bağlanmakta ve bu sayede darbe ve trafiğe karşı fevkalade direnç göstermektedir.

• Hipokrat, TC Sağlık Bakanlığı'nın Sağlık Yatırımları Genel Müdürlüğü, Etüd proje Emlak Daire Başkanlığı'nın 1672 sayılı mevcut ve yeni yapılacak Sağlık tesislerinde Uyulması Gereken Asgari teknik Standartları Genelgesi'ne ilişkin 2018 tarihli Revizyon'da belirtilen teknik özelliklere uygundur.

• Grup-T aşınma grubunda yer alan Hipokrat, Tip-I bağlayıcı oranına sahip kalenderlenmiş kompakt yapısıyla yoğun trafik alanlarda da uzun ömürlü bir kullanım sunmaktadır.

• Hipokrat, Y.25.116/A05 pozuna uygundur.

• Poliüretan esaslı PURGuard yüzey koruma sistemiyle güçlendirilmiş olan Hipokrat toz ve kir izlerini açıkça belli etmeyen ve kolayca temizlenebilen bir niteliktedir. PURGuard teknolojisi, kalenderlenmiş aşınma tabakasına mükemmel bir seviyede tutunarak çizilmelere karşı bir kalkan niteliği kazanmaktadır.

• Neredeyse dolgu içermeyen özel formülü sayesinde sağlık tesislerindeki statik yükü azaltmak üzere standart ürünlerine göre yaklaşık %5 hafifletmiştir.

• Su emmeyen, köpük-kabartılmış, genişletilmiş köpük, mantar, tekstil içermeyen yapısı ile Hipokrat, doğru döşeme uygulamaları ile kimyasallarla sterilizasyona uygun, ıslak temizliğe yatkin, hijyenik bir üründür.

• Hipokrat sadece virgin PVC kullanılarak üretilen içeriği %100 izlenebilir bir üründür. İçerisinde kullanılan tüm kimyasallar yürürlükteki kimyasal regülasyonlarla uyumluluğu takip edilebilir niteliktedir.

• Hipokrat, cam elyafı takviyesiyle en soğuk ve en sıcak coğrafyalardaki sağlık tesislerinde de hijyen ve temizlik performansını maksimize edecek bir niteliktedir.

• Hipokrat, %100 geri dönüştürülebilir ve tekrar kullanılabilir yapısıyla karbon ayak izinizi düşürmenize yardımcı olacaktır.

• Mat görüntüsü ve 13 pastel renk varyantıyla özellikle sade ve dingin bir atmosfer arayışındaki mimari çözümler için yeterli bir taban sunmaktadır.

• Hipokrat является специализированным членом семейства продуктов для медицинских учреждений. Частицы NetFloor Hipokrat, который производится почти без наполнителя, связываются друг с другом с максимальной силой сцепления и, таким образом, обеспечивают исключительную устойчивость к ударам и движению.

• Hipokrat соответствует техническим спецификациям, указанным Министерством здравоохранения Турецкой Республики, Главным управлением инвестиций в здравоохранение и Департаментом недвижимости в Своде минимальных технических стандартов, которые должны соблюдаться в существующих и новых медицинских учреждениях, Статья 1672, ревизия 2018 года.

• Hipokrat, относящийся к группе износа "Т", обеспечивает длительное использование в зонах с интенсивным движением, благодаря своей компактной каландрированной структуре с соотношением связующего вещества типа "I".

• Hipokrat соответствует позиции Y.25.116/A05.

• Hipokrat, армированный системой защиты поверхности PURGuard на полиуретановой основе, на нем незаметны следы пыли и грязи, а также покрытие легко очищается. Технология PROGuard обеспечивает защиту от царапин, сохраняя каландрированный слой износа на идеальном уровне.

• Благодаря специальной формуле, не содержащей наполнителя, данный продукт примерно на 5% легче, чем стандартные изделия, что позволяет снизить статическую нагрузку в медицинских учреждениях.

• Не впитывающий влагу Hipokrat, не содержащий вспененной, пробковой структуры и текстильных материалов, представляет собой гигиеничный продукт, который отлично подходит для стерилизации химическими веществами для влажной уборки при правильном применении укладки напольного покрытия.

• Hipokrat, в производстве которого используется первичный ПВХ, является полностью отслеживаемым продуктом. Все химические вещества, используемые в нем, соответствуют с действующими химическими нормами.

• Hipokrat, благодаря армированной стекловолокном поверхности, подходит для обеспечения максимальной гигиены и эффективности очистки в медицинских учреждениях даже в самых холодных и жарких регионах.

• Hipokrat, с 100% перерабатываемой и пригодной для вторичной обработки структурой способствует уменьшению углеродного следа.

• Благодаря своему матовому виду и 13 вариантам пастельных цветов, покрытие обеспечивает достаточную основу для архитектурных решений, направленных на создание простой и спокойной атмосферы.



## Layer Diagrams

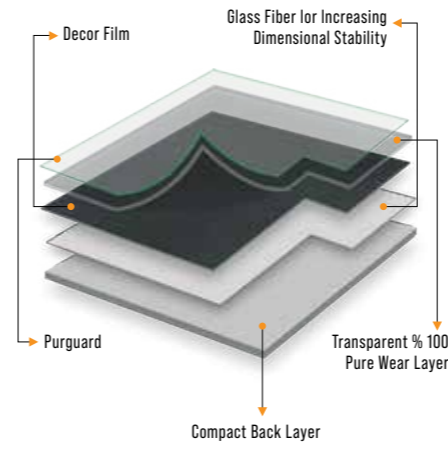

"Some products may use a different product architecture than the illustration above."

## Katman Şemaları

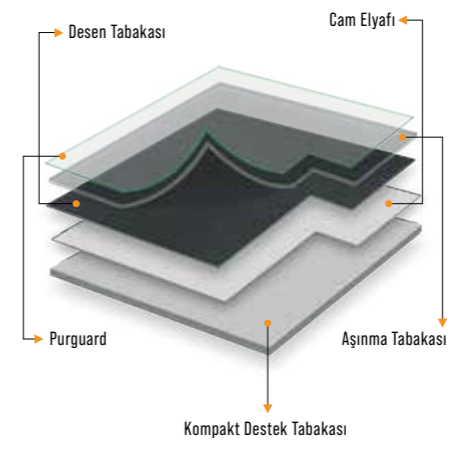

"Kimi ürünlerde, yukarıdaki gösterimden farklı ürün mimarisini kullanılabılır."

## Диаграммы слоев

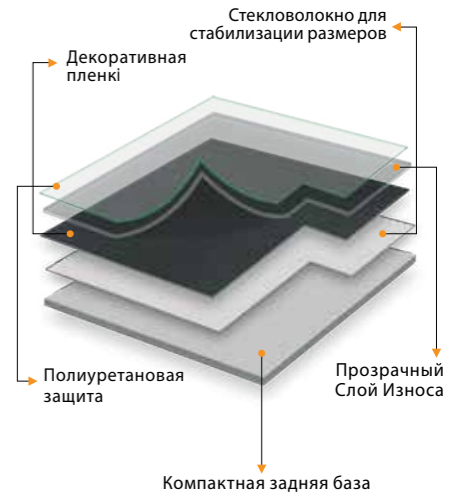

"Некоторые продукты могут использовать архитектуру продукта, отличную от той, что показана на рисунке выше."



TS EN 10 582



TS EN 10 582



## Specifications

## Özellikler

## Характеристики

GLASS FIBER TISSUE : OK  
PURGUARD : OK

## TECHNICAL DATA SHEET

PRODUCT IDENTIFICATION: HİPOKRAT 2 mm - 0.70 mm

## TECHNICAL PROPERTIES

SPECIFICATION	STANDARD	PRODUCT
Certificate No	TS EN ISO 10582	008885-TSE-04/03
Usage Class	EN ISO 10874	Commercial: 34 Industrial: 43
Total Thickness	EN ISO 24346	2 mm
Total Weight	EN ISO 23997	2945 g/m <sup>2</sup>
Wear Layer Thickness	EN ISO 24340	0.70 mm
Roll Width	EN ISO 24341	2 m
Roll Length	EN ISO 24341	20 m
PERFORMANCE		
Wear Layer Group	EN 660-2	GROUP T
Binder Content	ISO 10582	TYPE 1
Effect of a Castor Chair	ISO 4918	No deformation after 25.000 cycles
Test for Color Fastness	EN ISO 105-B02	≥6
Dimensional Stability	EN ISO 23999	0.24 %
Curling	EN ISO 23999	0.8 mm
Residual Indentation	EN ISO 24343-1	0.05 mm
Seam Strength	EN 684	549 N/50 mm
Flexibility	EN ISO 24344	No Crack
Evaluation of the Action of Microorganisms	EN ISO 846-C	Does not contribute to bacterial growth
Formaldehyde Emission	EN 717-1	Class E 1
Fire Classification	EN 13501-1	Bfl S1
Electrical Property	EN 1815	≤2kV Antistatic
Thermal Conductivity	EN 12667	0,0423 (m2K)/W
Slip Resistance	EN 13893	DS

\* Sipariş geçmeden önce, lütfen güncel TDS verilerini talep edin.

\* Before placing an order, please request up-to-date TDS data.

## For Health Facilities

## Sağlık Tesisleri İçin

## Для медицинских учреждений

## AURA ( 4A0 / 4A1 )



\*\* Real products may differ from above images. Please kindly note to ask for real products samples before confirming your order.

\*\* Gerçek ürünler yukarıdaki resimlerden farklı olabilir. Lütfen siparişinizi vermeden önce gerçek ürün numunelerini istemeyi unutmayın.

\*\* Реальные продукты могут отличаться от изображений выше. Пожалуйста, обратите внимание, чтобы запросить образцы реальной продукции перед подтверждением вашего заказа.



netflex

Multi-Layered  
Compact Vinyl Flooring

Çok Katmanlı  
Kompakt Vinil Döşeme

Многослойный Компактный  
Виниловый пол

netflex



**Heterogeneous Contract  
Floor Coverings**  
For Commercial Areas

Heterojen Kontrat  
Zemin Kaplamaları  
Ticari Alanlar İçin

Контрактные респоренные  
Нанонные покрытия  
Для коммерческих площадей

net  
FLOOR COVERINGS  
www.netfloor.com.tr



## Heterogeneous Contract Floor Coverings



## Heterojen Kontrat Zemin Kaplamaları



## КоНтраКТННле rereporeНННле HanonbHble noKpbITИ/ИH



- Is heterogeneous floor covering serving to different usage areas that may also need dense traffic resistance.
- Is a member of T-ab3rassion class which is the most durable class of PVC floor coverings.
- Has specially developed polyurethane. PURGUARD protection on its top surface.
- Can easily be cleaned with simple detergents thanks to PURGUARD.
- Provides maximum dimensional stability with its glass-fibre embedded structure.
- All Netflex products can be produced with preferred colour-design patterns chosen from our booklets and having a 1.50 mm-4.00 mm total thickness.
- All Netflex products can be produced with selected colour-design patterns chosen from our booklets and having a 0.30 – 1.20 mm wear layer thickness to be determined according to preferred total thickness.
- All Netflex products can be produced with preferred colour-design patterns chosen from our booklets in R10 anti-slippery class.

- Yoğun trafiğe de dayanımlı farklı kullanım alanlarına hitap eden heterojen zemin kaplamasıdır.
- Çok katmanlı yapısı ile en yüksek PVC zemin kaplaması aşınma grubu olan T-sınıfına mensuptur.
- En üst yüzeyinde özel olarak geliştirilmiş poliüretan PURGUARD koruması mevcuttur.
- PURGUARD sayesinde en basit temizleyiciler ile kolayca temizlenebilir.
- Cam elyafı içeren yapısı ile maksimum boyut kararlılığına sahiptir.
- Tüm Netflex ürünleri, kataloglarımızdan seçilen renk ve desen görselliğinde ve 1.50 mm-4.00 mm toplam kalınlıkta üretilebilir.
- Tüm Netflex ürünleri, kataloglarımızdan seçilen renk ve desen görselliğinde ve belirlenen toplam kalınlığa göre seçilecek 0.30mm-1.20mm aşınma tabakası kalınlığında üretilebilir.
- Tüm Netflex ürünleri, kataloglarımızdan seçilen renk ve desen görselliğinde R10 kaymazlık sınıfında üretilebilir.

- Покрытие, которое можно использовать в различных сферах и устойчивое к интенсивному дорожному движению.
- Обладает многослойной структурой и относится к классу Т, являющемуся наиболее устойчивому к износу среди покрытий из ПВХ.
- Обладает новой полиуретановой защитой PURGUARD, разработанной на самом высоком уровне.
- PURGUARD обеспечивает легкую чистку даже самыми простыми чистящими средствами.
- Структура, включающая стеклянные волокна, обладает максимальной стабильностью частиц.
- Все виды продукции Netflex могут изготавливаться общей толщиной 1.50 мм-4.00 мм цветов и узоров, которые можно выбрать из наших каталогов.
- Все виды продукции Netflex могут изготавливаться с толщиной износа 0.30мм-1.20 мм цветов и узоров, которые можно выбрать из наших каталогов.
- Все виды продукции Netflex обладают классом устойчивости к скольжению R10 цветов и узоров, которые можно выбрать из наших каталогов.



## Layer Diagrams



## Katman Şemaları



## Диаграммы слоев

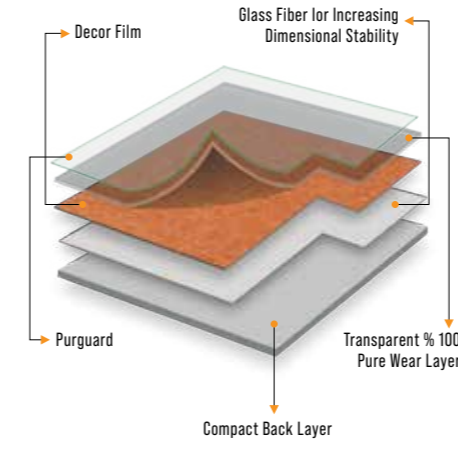

"Some products may use a different product architecture than the illustration above."

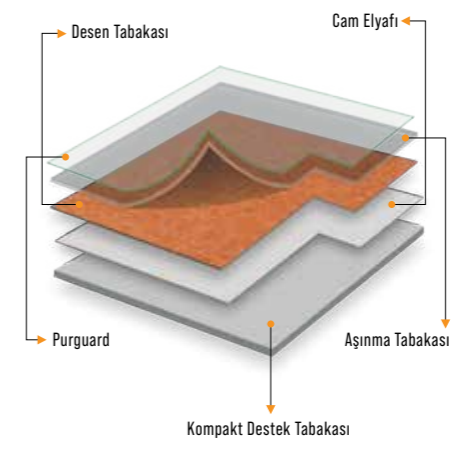

"Kimi ürünlerde, yukarıdaki gösterimden farklı ürün mimarisi kullanılabilir."

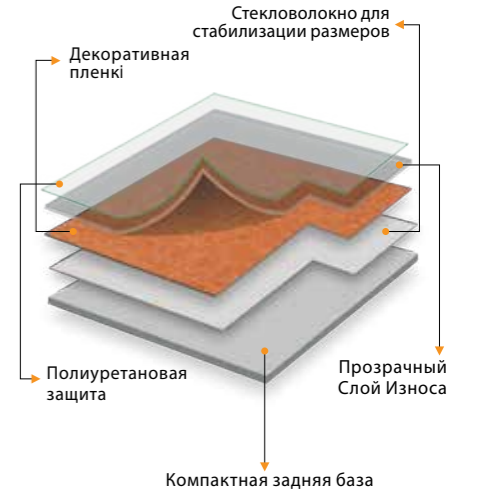

"Некоторые продукты могут использовать архитектуру продукта, отличную от той, что показана на рисунке выше."



GLASS FIBER TISSUE : OK  
PURGUARD : OK

## TECHNICAL DATA SHEET

## PRODUCT IDENTIFICATION : NETFLEX

## TECHNICAL PROPERTIES

SPECIFICATION	STANDARD	PRODUCT					
Usage Class	EN ISO 10874	Domestic: 21	Domestic: 23	Domestic: 23 Commercial: 31	Commercial: 32 Industrial: 41	Commercial: 33 Industrial: 42	Commercial: 34 Industrial: 43
Total Thickness	EN ISO 24346	1.50 mm (min:-0.10 mm max: 0.13 mm)	1.50 mm (min:-0.10 mm max: 0.13 mm)	2 mm (min:-0.10 mm max: 0.13 mm)	2 mm (min:-0.10 mm max: 0.13 mm)	2 mm (min:-0.10 mm max: 0.13 mm)	2 mm (min:-0.10 mm max: 0.13 mm)
Wear Layer Thickness	EN ISO 24340	0.15 mm (max:+%13 min: -%10)	0.30 mm (max:+%13 min: -%10)	0.30 mm (max:+%13 min: -%10)	0.40 mm (max:+%13 min: -%10)	0.55 mm (max:+%13 min: -%10)	0.70 mm (max:+%13 min: -%10)
Total Weight	EN ISO 23997	2320 g/m <sup>2</sup> (max:+%13 min: -%10)	2250 g/m <sup>2</sup> (max:+%13 min: -%10)	2990 g/m <sup>2</sup> (max:+%13 min: -%10)	2965 g/m <sup>2</sup> (max:+%13 min: -%10)	3100 g/m <sup>2</sup> (max:+%13 min: -%10)	3010 g/m <sup>2</sup> (max:+%13 min: -%10)
Roll Width	EN ISO 24341	2 m	2 m	2 m	2 m	2 m	2 m
Roll Length	EN ISO 24341	20 m	20 m	20 m	20 m	20 m	20 m

## PERFORMANCE

Wear Layer Group	EN 660-2	GROUP T	GROUP T	GROUP T	GROUP T	GROUP T	GROUP T
Binder Content	ISO 10582	TYPE 1	TYPE 1	TYPE 1	TYPE 1	TYPE 1	TYPE 1
Effect of a Castor Chair	ISO 4918	N/A	N/A	No deformation after 25.000 cycles	No deformation after 25.000 cycles	No deformation after 25.000 cycles	No deformation after 25.000 cycles
Test for Color Fastness	EN ISO 105-B02	≥6	≥6	≥6	≥6	≥6	≥6
Dimensional Stability	EN ISO 23999	≤%0.4	≤%0.4	≤%0.4	≤%0.4	≤%0.4	≤%0.4
Curling	EN ISO 23999	Max:8 mm	Max:8 mm	Max:8 mm	Max:8 mm	Max:8 mm	Max:8 mm
Residual Indentation	EN ISO 24343-1	≤0.1 mm	≤0.1 mm	≤0.1 mm	≤0.1 mm	≤0.1 mm	≤0.1 mm
Determination of Staining and Resistance to Chemicals	EN ISO 26987	Ok	Ok	Ok	Ok	Ok	Ok
Seam Strength	EN 684	N/A	N/A	≥240 N/50 mm	≥240 N/50 mm	≥240 N/50 mm	≥240 N/50 mm
Flexibility	EN ISO 24344	No Crack	No Crack	No Crack	No Crack	No Crack	No Crack
Evaluation of the Action of Microorganisms	EN ISO 846 C	Does not contribute to bacterial growth	Does not contribute to bacterial growth	Does not contribute to bacterial growth	Does not contribute to bacterial growth	Does not contribute to bacterial growth	Does not contribute to bacterial growth
Formaldehyde Emission	EN 717-1	Class E 1	Class E 1	Class E 1	Class E 1	Class E 1	Class E 1
Fire Classification	EN 13501-1	Bfl S1	Bfl S1	Bfl S1	Bfl S1	Bfl S1	Bfl S1
Electrical Property	EN 1815	≤2kV Antistatic	≤2kV Antistatic	≤2kV Antistatic	≤2kV Antistatic	≤2kV Antistatic	≤2kV Antistatic
Thermal Conductivity	EN 12667	0,0167 (m2K)/W	0,0167 (m2K)/W	0,0167 (m2K)/W	0,0167 (m2K)/W	0,0167 (m2K)/W	0,0167 (m2K)/W
Slip Resistance	EN 13893	DS	DS	DS	DS	DS	DS

\* Sipariş geçmeden önce, lütfen güncel TDS verilerini talep edin.

\* Before placing an order, please request up-to-date TDS data.

GLASS FIBER TISSUE : OK  
PURGUARD : OK

## TECHNICAL DATA SHEET

## PRODUCT IDENTIFICATION : NETFLEX

## TECHNICAL PROPERTIES

SPECIFICATION	STANDARD	PRODUCT					
Usage Class	EN ISO 10874	Commercial: 34 Industrial: 43	Commercial: 34 Industrial: 43	Commercial: 34 Industrial: 43	Commercial: 33 Industrial: 42	Commercial: 34 Industrial: 43	Commercial: 34 Industrial: 43
Total Thickness	EN ISO 24346	2.50 mm (min:-0.10 mm max: 0.13 mm)	3 mm (min:-0.10 mm max: 0.13 mm)	3 mm (min:-0.10 mm max: 0.13 mm)	4 mm (min:-0.10 mm max: 0.13 mm)	4 mm (min:-0.10 mm max: 0.13 mm)	4 mm (min:-0.10 mm max: 0.13 mm)
Wear Layer Thickness	EN ISO 24340	0.80 mm (max:+%13 min: -%10)	1 mm (max:+%13 min: -%10)	1.20 mm (max:+%13 min: -%10)	0.55 mm (max:+%13 min: -%10)	1 mm (max:+%13 min: -%10)	1.20 mm (max:+%13 min: -%10)
Total Weight	EN ISO 23997	3730 g/m <sup>2</sup> (max:+%13 min: -%10)	4500 g/m <sup>2</sup> (max:+%13 min: -%10)	4370 g/m <sup>2</sup> (max:+%13 min: -%10)	6550 g/m <sup>2</sup> (max:+%13 min: -%10)	6300 g/m <sup>2</sup> (max:+%13 min: -%10)	6100 g/m <sup>2</sup> (max:+%13 min: -%10)
Roll Width	EN ISO 24341	2 m	2 m	2 m	2 m	2 m	2 m
Roll Length	EN ISO 24341	20 m	20 m	20 m	20 m	20 m	20 m

## PERFORMANCE

Wear Layer Group	EN 660-2	GROUP T	GROUP T	GROUP T	GROUP T	GROUP T	GROUP T
Binder Content	ISO 10582	TYPE 1	TYPE 1	TYPE 1	TYPE 1	TYPE 1	TYPE 1
Effect of a Castor Chair	ISO 4918	No deformation after 25.000 cycles	No deformation after 25.000 cycles	No deformation after 25.000 cycles	No deformation after 25.000 cycles	No deformation after 25.000 cycles	No deformation after 25.000 cycles
Test for Color Fastness	EN ISO 105-B02	≥6	≥6	≥6	≥6	≥6	≥6
Dimensional Stability	EN ISO 23999	≤%0.4	≤%0.4	≤%0.4	≤%0.4	≤%0.4	≤%0.4
Curling	EN ISO 23999	Max:8 mm	Max:8 mm	Max:8 mm	Max:8 mm	Max:8 mm	Max:8 mm
Residual Indentation	EN ISO 24343-1	≤0.1 mm	≤0.1 mm	≤0.1 mm	≤0.1 mm	≤0.1 mm	≤0.1 mm
Determination of Staining and Resistance to Chemicals	EN ISO 26987	Ok	Ok	Ok	Ok	Ok	Ok
Seam Strength	EN 684	≥240 N/50 mm	≥240 N/50 mm	≥240 N/50 mm	≥240 N/50 mm	≥240 N/50 mm	≥240 N/50 mm
Flexibility	EN ISO 24344	No Crack	No Crack	No Crack	No Crack	No Crack	No Crack
Evaluation of the Action of Microorganisms	EN ISO 846 C	Does not contribute to bacterial growth	Does not contribute to bacterial growth	Does not contribute to bacterial growth	Does not contribute to bacterial growth	Does not contribute to bacterial growth	Does not contribute to bacterial growth
Formaldehyde Emission	EN 717-1	Class E 1	Class E 1	Class E 1	Class E 1	Class E 1	Class E 1
Fire Classification	EN 13501-1	Bfl S1	Bfl S1	Bfl S1	Bfl S1	Bfl S1	Bfl S1
Electrical Property	EN 1815	≤2kV Antistatic	≤2kV Antistatic	≤2kV Antistatic	≤2kV Antistatic	≤2kV Antistatic	≤2kV Antistatic
Thermal Conductivity	EN 12667	0,0167 (m2K)/W	0,0167 (m2K)/W	0,0167 (m2K)/W	0,0167 (m2K)/W	0,0167 (m2K)/W	0,0167 (m2K)/W
Slip Resistance	EN 13893	DS	DS	DS	DS	DS	DS

\* Sipariş geçmeden önce, lütfen güncel TDS verilerini talep edin.

\* Before placing an order, please request up-to-date TDS data.

Multi-Layered Vinyl Flooring

Çok Katmanlı Vinil Döşeme

Многослойный виниловый пол

## SANTE ( 492 / 493 / 494 / 495 )

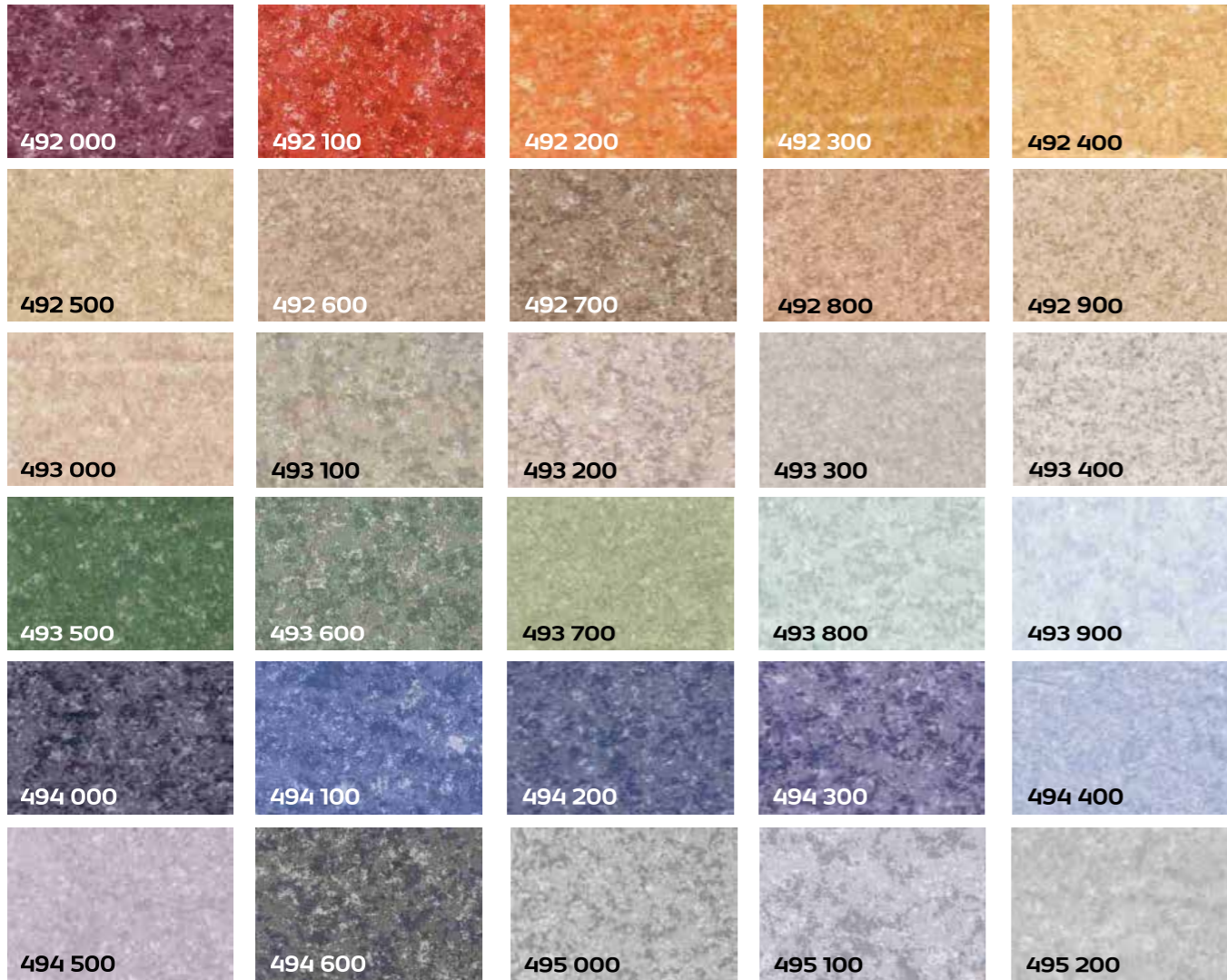

## TIRETS ( 220 / 221 )



\*\* Real products may differ from above images. Please kindly note to ask for real products samples before confirming your order.

\*\* Gerçek ürünler yukarıdaki resimlerden farklı olabilir. Lütfen siparişinizi vermeden önce gerçek ürün numunelerini istemeyi unutmayın.

\*\* Реальные продукты могут отличаться от изображений выше. Пожалуйста, обратите внимание, чтобы запросить образцы реальной продукции перед подтверждением вашего заказа.

Multi-Layered Vinyl Flooring

Çok Katmanlı Vinil Döşeme

Многослойный виниловый пол

## JOKER ( 200 / 201 / 202 )

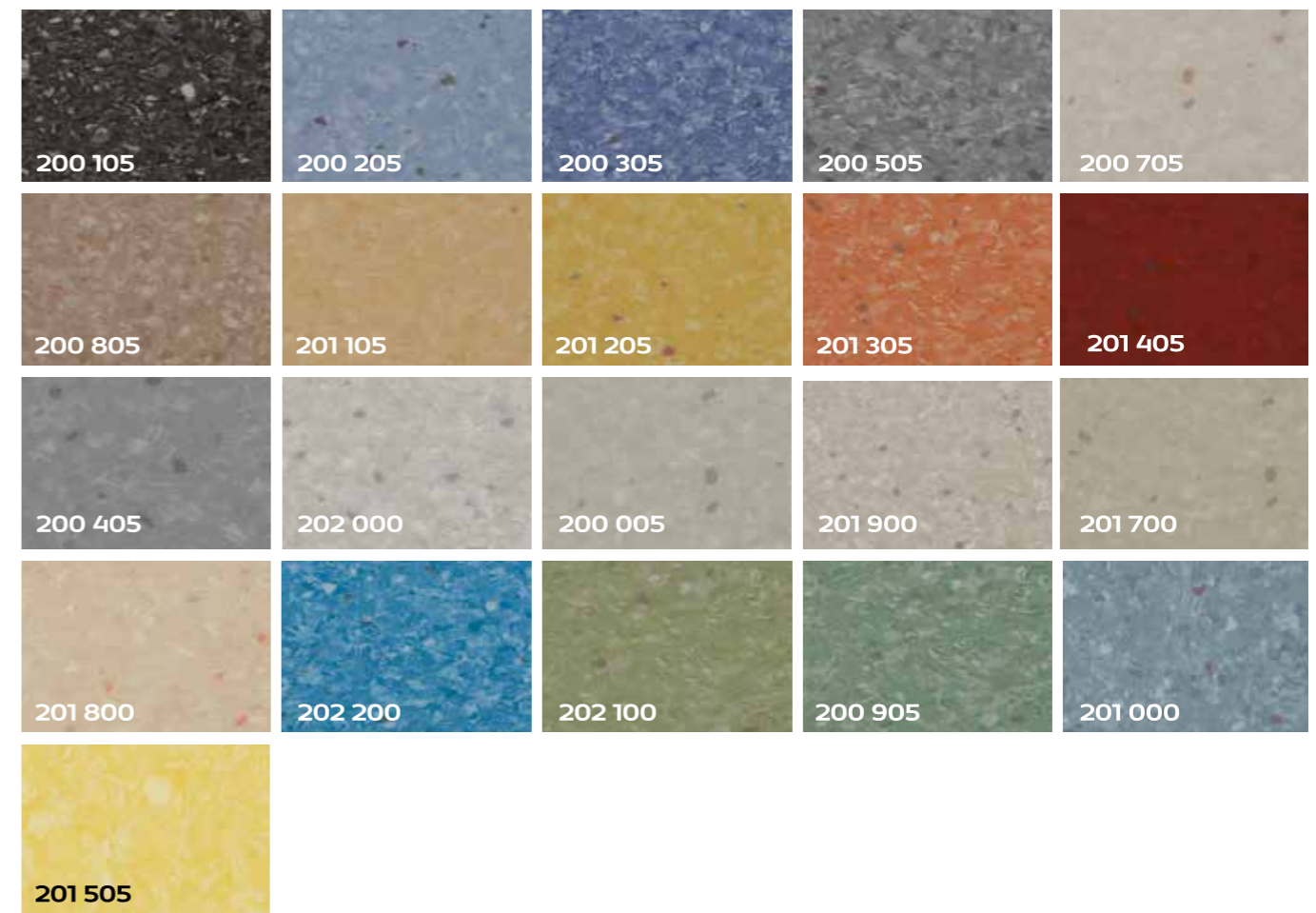

## MODERNO ( 110 / 111 )

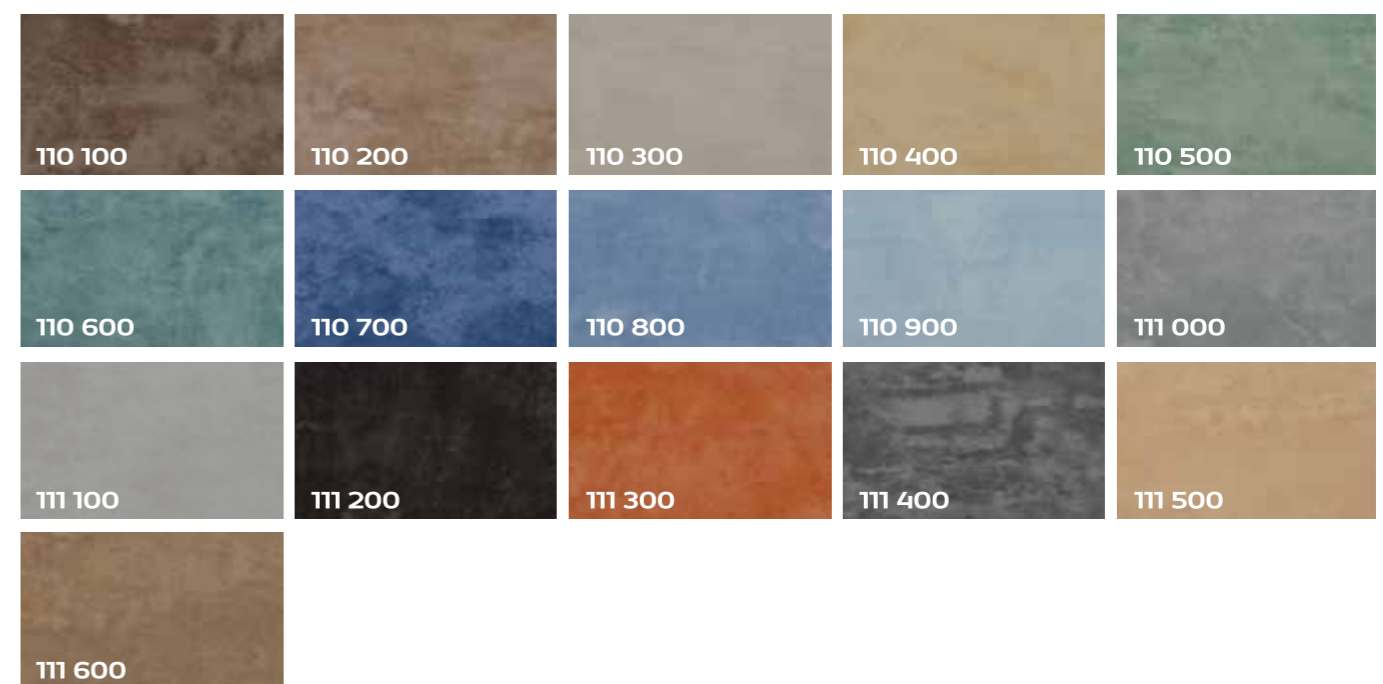

\*\* Real products may differ from above images. Please kindly note to ask for real products samples before confirming your order.

\*\* Gerçek ürünler yukarıdaki resimlerden farklı olabilir. Lütfen siparişinizi vermeden önce gerçek ürün numunelerini istemeyi unutmayın.

\*\* Реальные продукты могут отличаться от изображений выше. Пожалуйста, обратите внимание, чтобы запросить образцы реальной продукции перед подтверждением вашего заказа.

Multi-Layered Vinyl Flooring

Çok Katmanlı Vinil Döşeme

Многослойный виниловый пол

## BETONIST (210)



## NEO WOOD ( 150 / 151 )

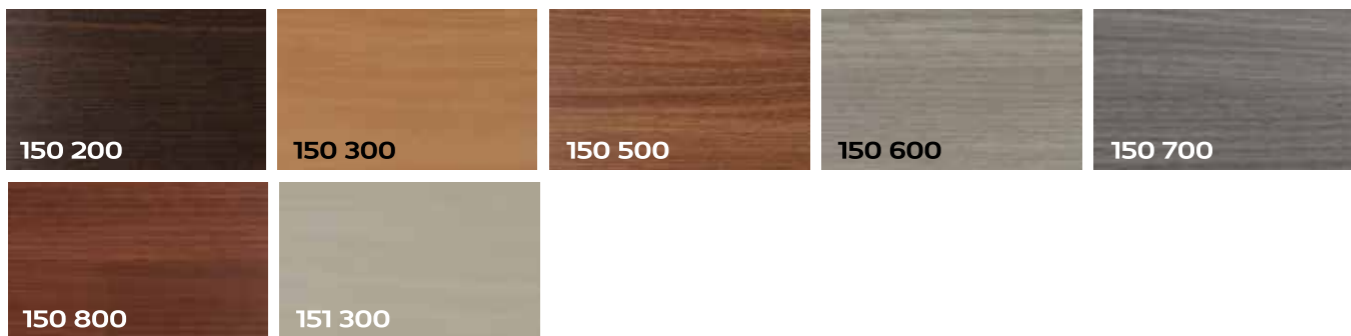

## GAIA ( 100 / 101 )

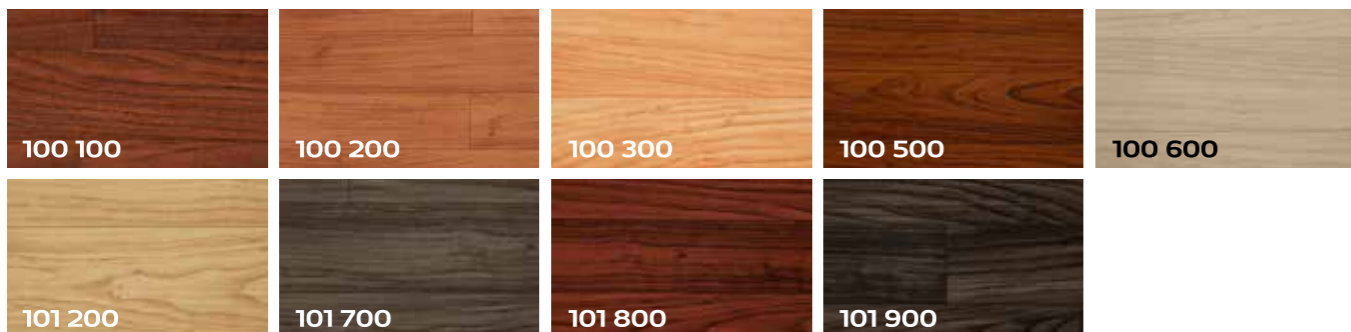

## TRADITION ( 330 / 331 )



\*\* Real products may differ from above images. Please kindly note to ask for real products samples before confirming your order.

\*\* Gerçek ürünler yukarıdaki resimlerden farklı olabilir. Lütfen siparişinizi vermeden önce gerçek ürün numunelerini istemeyi unutmayın.

\*\* Реальные продукты могут отличаться от изображений выше. Пожалуйста, обратите внимание, чтобы запросить образцы реальной продукции перед подтверждением вашего заказа.

Multi-Layered Vinyl Flooring

Çok Katmanlı Vinil Döşeme

Многослойный виниловый пол

## MUNDI ( 295 / 296 )

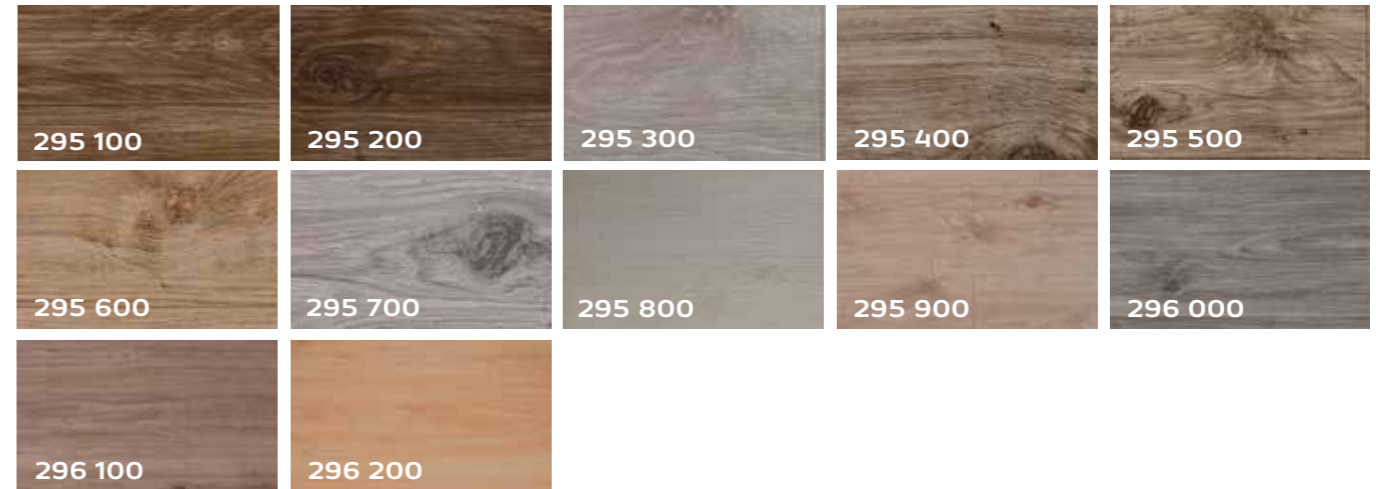

## WOODLINE ( 280 / 281 )

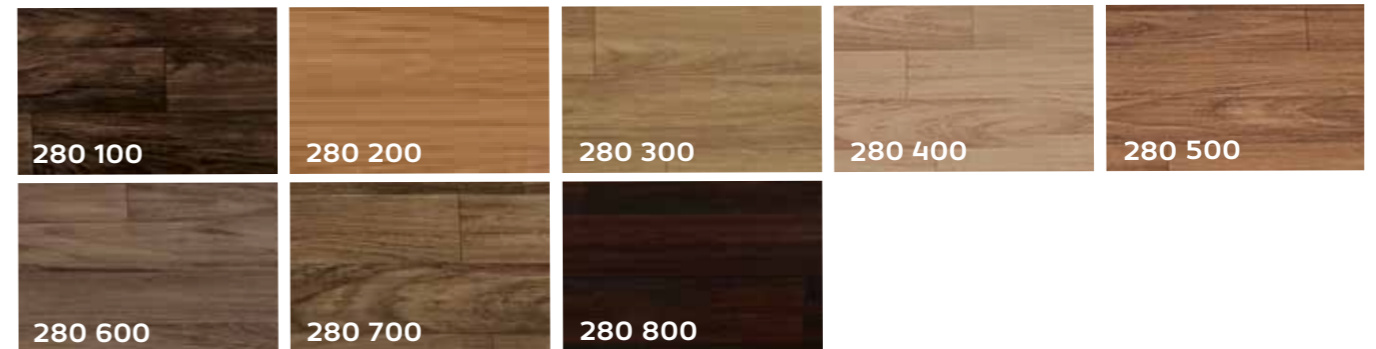

## NEO SAGA ( 231 / 235 / 236 )



\*\* Real products may differ from above images. Please kindly note to ask for real products samples before confirming your order.

\*\* Gerçek ürünler yukarıdaki resimlerden farklı olabilir. Lütfen siparişinizi vermeden önce gerçek ürün numunelerini istemeyi unutmayın.

\*\* Реальные продукты могут отличаться от изображений выше. Пожалуйста, обратите внимание, чтобы запросить образцы реальной продукции перед подтверждением вашего заказа.

Multi-Layered Vinyl Flooring

Çok Katmanlı Vinil Döşeme

Многослойный виниловый пол

## NEO UNACO ( 300 / 301 / 302 )



## ASSOS ( 560 / 561 )

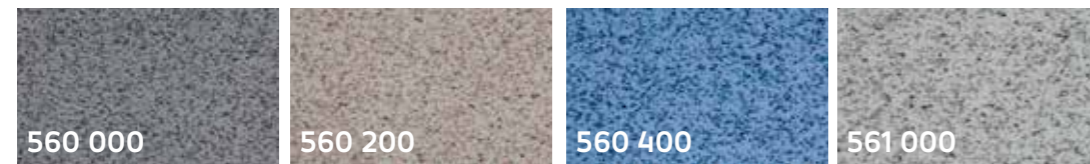

## SHARPY ( 455 / 456 )

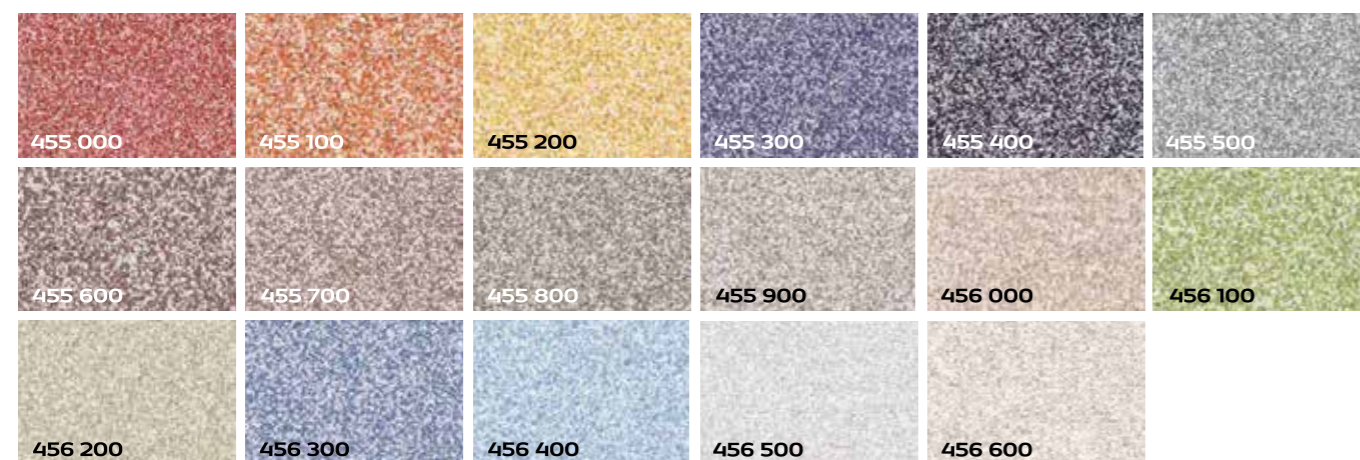

\*\* Real products may differ from above images. Please kindly note to ask for real products samples before confirming your order.

\*\* Gerçek ürünler yukarıdaki resimlerden farklı olabilir. Lütfen siparişinizi vermeden önce gerçek ürün numunelerini istemeyi unutmayın.

\*\* Реальные продукты могут отличаться от изображений выше. Пожалуйста, обратите внимание, чтобы запросить образцы реальной продукции перед подтверждением вашего заказа.

Multi-Layered Vinyl Flooring

Çok Katmanlı Vinil Döşeme

Многослойный виниловый пол

## SPECTRA ( 780 / 781 )



## PERA ( 450 / 451 )

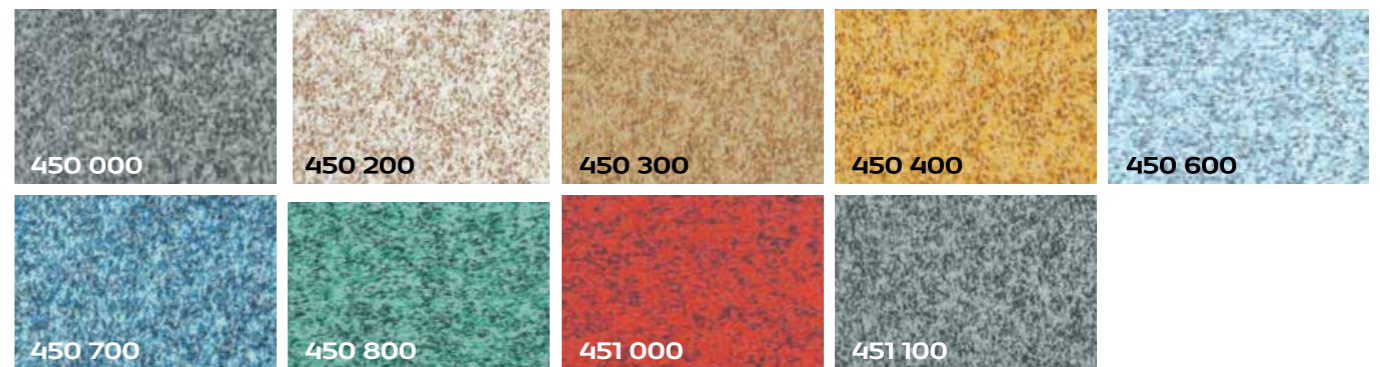

## SEVEN ( 350 / 351 )



## VEGA ( 890 / 891 )



\*\* Real products may differ from above images. Please kindly note to ask for real products samples before confirming your order.

\*\* Gerçek ürünler yukarıdaki resimlerden farklı olabilir. Lütfen siparişinizi vermeden önce gerçek ürün numunelerini istemeyi unutmayın.

\*\* Реальные продукты могут отличаться от изображений выше. Пожалуйста, обратите внимание, чтобы запросить образцы реальной продукции перед подтверждением вашего заказа.

Multi-Layered Vinyl Flooring

Çok Katmanlı Vinil Döşeme

Многослойный виниловый пол

## NEO EFES ( 120 / 121 / 122 )

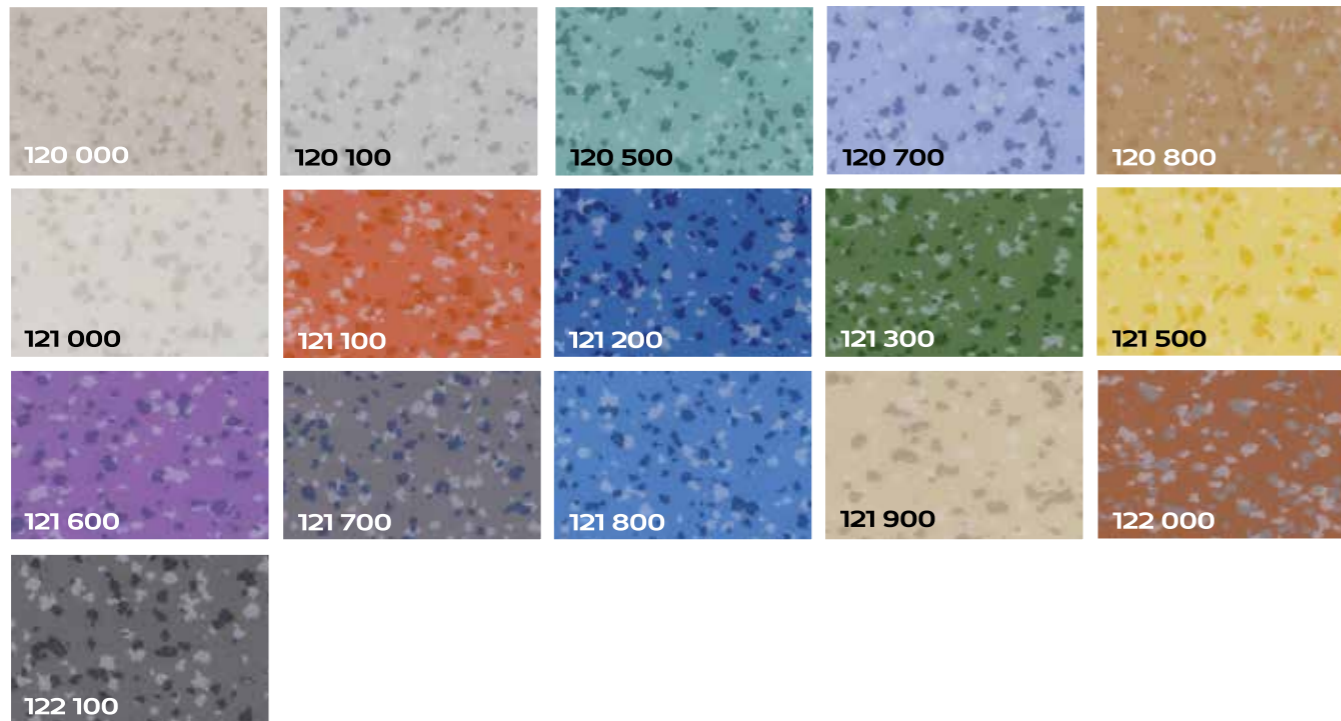

## NEO IDEA ( 900 / 901 / 905 )

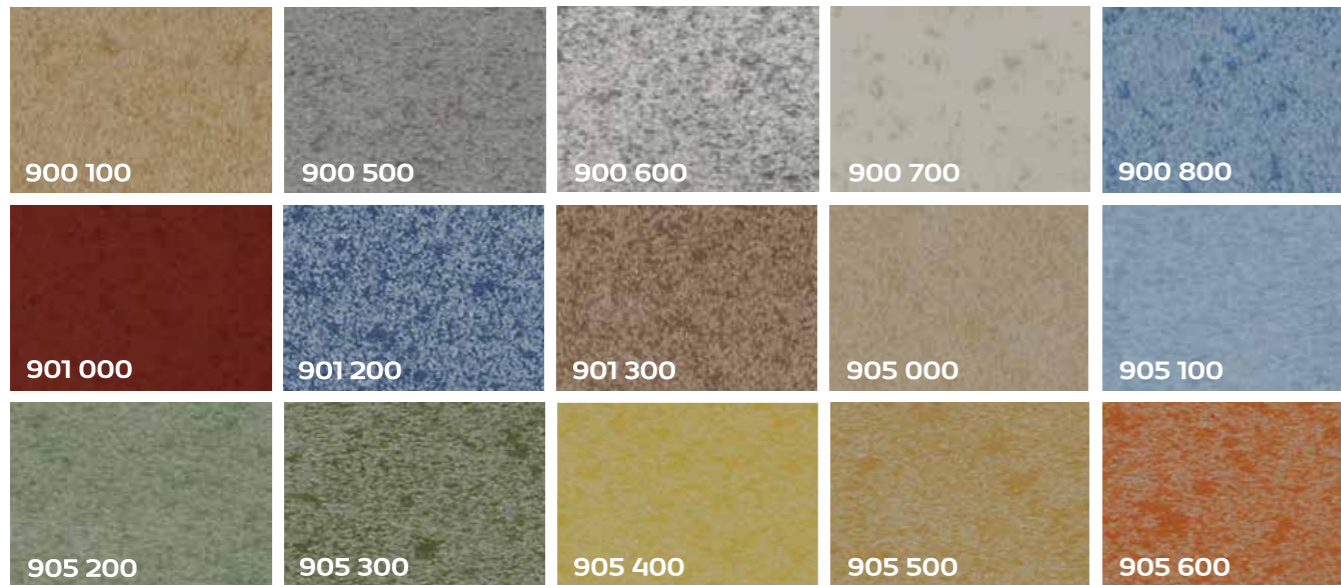

## MARMARON ( 460 )



\*\* Real products may differ from above images. Please kindly note to ask for real products samples before confirming your order.

\*\* Gerçek ürünler yukarıdaki resimlerden farklı olabilir. Lütfen siparişinizi vermeden önce gerçek ürün numunelerini istemeyi unutmayın.

\*\* Реальные продукты могут отличаться от изображений выше. Пожалуйста, обратите внимание, чтобы запросить образцы реальной продукции перед подтверждением вашего заказа.

Multi-Layered Vinyl Flooring

Çok Katmanlı Vinil Döşeme

Многослойный виниловый пол

## SANTE 22 ( 492 / 493 / 494 / 495 )

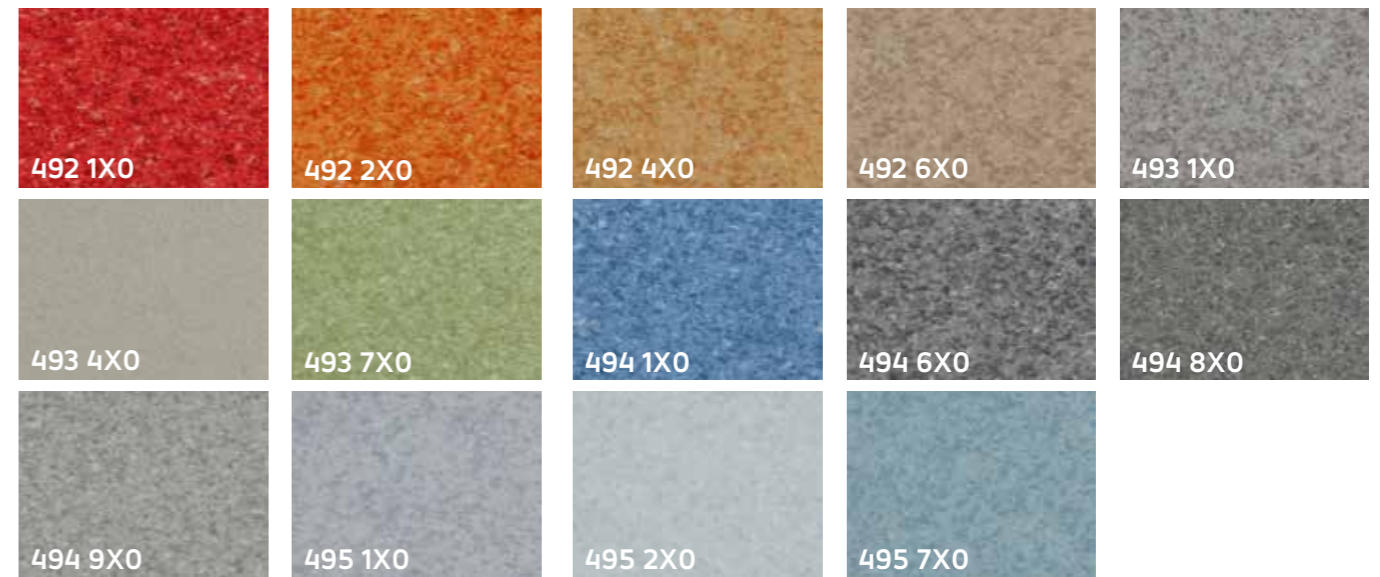

## MUNDI 22 ( 296 / 297 )

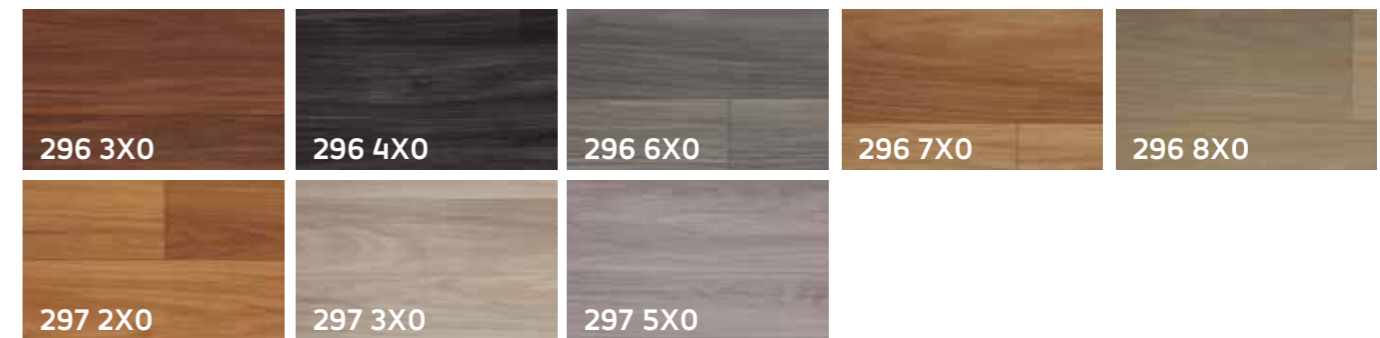

## BETONIST 22 ( 210 )



## TRADITION 22

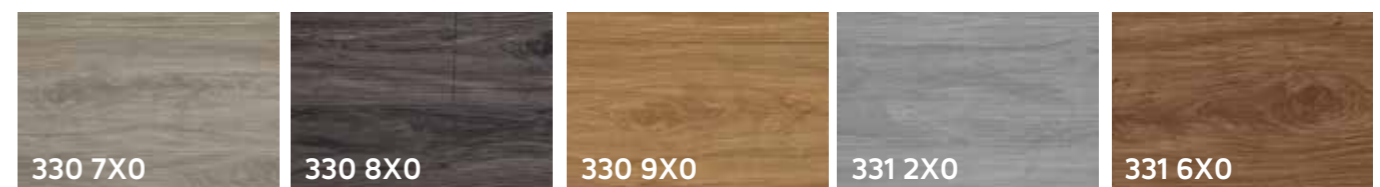

\*\* Real products may differ from above images. Please kindly note to ask for real products samples before confirming your order.

\*\* Gerçek ürünler yukarıdaki resimlerden farklı olabilir. Lütfen siparişinizi vermeden önce gerçek ürün numunelerini istemeyi unutmayın.

\*\* Реальные продукты могут отличаться от изображений выше. Пожалуйста, обратите внимание, чтобы запросить образцы реальной продукции перед подтверждением вашего заказа.



Heterogeneous Commercial  
Floor Coverings

Heterojen Ticari  
Zemin Kaplamaları

Гетерогенная коммерческая  
Напольная плитка

[N-LVT]



Luxury Vinyl Tile

Lüks Vinil Karo

Роскошная виниловая  
плитка

net  
FLOOR COVERINGS

[www.netfloor.com.tr](http://www.netfloor.com.tr)

[N-LVT]



## Heterogeneous Commercial Floor Coverings



## Heterojen Ticari Zemin Kaplamaları



## Гетерогенная коммерческая HanonbHble noKpbITI/ИH



• Is heterogeneous floor covering serving to different usage areas that may also need dense traffic resistance.

• Can be manufactured in various rectangle and square dimensions in line with the chosen design options.

• Is a member of T-abrassion class which is the most durable class of PVC floor coverings with its calendered transparent wear layer.

• Has specially developed polyurathane PURGuard protection on its top surface.

• Can easily be cleaned with simple detergents thanks to PURGuard.

• Provides maximum dimensional stability with its glass-fibre embedded structure.

• All N-LVT products can be produced with preferred colour-design patterns chosen from our booklets and having 2.00 mm – 4.00mm total thickness.

• All N-LVT products can be produced with selected colour-design patterns chosen from our booklets and having a 0.30mm – 1.00mm wear layer thickness to be determinend according to preferred total thickness.

• Some N-LVT products can be produced with custom-ised colour-design patterns chosen from our booklets in R10 anti-slippery class (OPTIONAL).

• Are produced 100% recyclable.

• Yoğun trafiğe de dayanımlı farklı kullanım alanlarına hitap eden heterojen zemin kaplamasıdır.

• Kataloglarımızdan seçilen desen seçeneklerine göre farklı ölçülerdeki lata veya karo ebatlarında üretilebilir.

• Kalenderlenmiş şeffaf aşınma tabakası ile en yüksek dayanımlı PVC zemin kaplaması aşınma grubu olan T-sınıfına mensuptur.

• En üst yüzeyinde özel olarak geliştirilmiş poliüretan PURGUARD koruması mevcuttur.

• PURGUARD sayesinde en basit temizleyiciler ile kolayca temizlenebilir.

• Cam elyafı içeren yapısı ile maksimum boyut kararlılığına sahiptir.

• Tüm N-LVT ürünleri, kataloglarımızdan seçilen renk ve desen görselliğinde ve 2.00 mm-4,00 mm toplam kalınlıkta üretilebilir.

• Tüm N-LVT ürünleri, kataloglarımızdan seçilen renk ve desen görselliğinde ve belirlenen toplam kalınlığa göre seçilecek 0,30 mm – 1,00 mm aşınma tabakası kalınlığında üretilebilir.

• N-LVT ürünleri, belirli renk ve desen seçeneklerinde, opsiyonel olarak R10 kaymazlık sınıfında üretilebilir.

• Представляет собой разнородное напольное покрытие, предназначенное для использования в различных помещениях, также устойчивых к интенсивному движению.

• Продукция может изготавливаться различных типоразмеров lata («планка») и karo («напольная плитка») в зависимости от выбранного из наших каталогов типа рисунка.

• Благодаря прозрачному календрованному слою для придания износостойкости относится к группе Т по износостойкости, в которую входят самые износостойкие напольные ПВХ-покрытия.

• На поверхность нанесен специально разработанный полиуретановый защитный слой с истемы «PURGUARD».

• Благодаря защите PURGUARD легко чистится с помощью простых чистящих средств.

• Благодаря структуре, содержащей стеклопластик, обладает максимальной размерной стабильностью.

• Вся продукция группы N-LVT может изготавливаться в представленной в наших каталогах цветовой палитре и с типом рисунка на выбор и общей толщиной от 2.00 мм до 4.00 мм.

• Вся продукция группы N-LVT может изготавливаться в представленной в наших каталогах цветовой палитре и с типом рисунка на выбор и со слоем для придания износостойкости толщиной от 0.30 мм до 1.00 мм в зависимости от выбранной общей толщины.

• Специальные партии N-LVT определенных цветовых исполнений и типов рисунка опционально могут изготавливаться согласно требованиям к группе R10 по устойчивости к скольжению.

• на 100 % пригоден для рециклинга (переработки).



## Layer Diagrams



## Katman Şemaları



## Диаграммы слоев

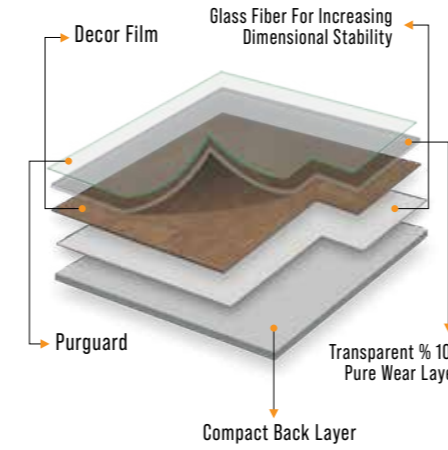

"Some products may use a different product architecture than the illustration above."

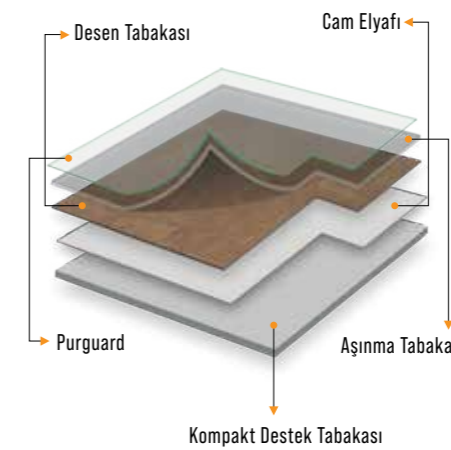

"Kimi ürünlerde, yukarıdaki gösterimden farklı ürün mimarisini kullanılabılır."

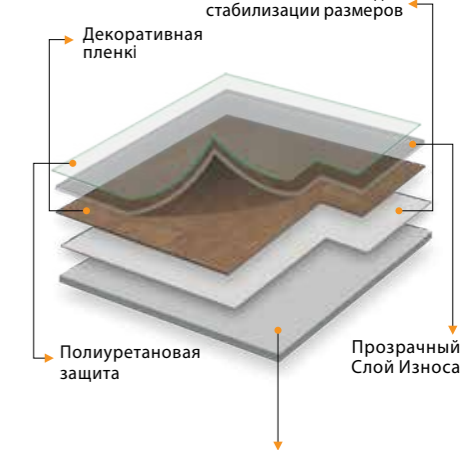

"Некоторые продукты могут использовать архитектуру продукта, отличную от той, что показана на рисунке выше."



GLASS FIBER TISSUE : OK  
PURGUARD : OK

TECHNICAL DATA SHEET

SPECIFICATION	STANDARD	PRODUCT									
		N-LVT DRY BACK					N-LVT LOOSE LAY				
Classification	EN ISO 10874	Commercial :32 Industrial :41	Commercial :33 Industrial :42	Commercial :34 Industrial :43	Commercial :33 Industrial :42	Commercial :34 Industrial :43	Commercial :33 Industrial :42	Commercial :34 Industrial :43	Commercial :31	Commercial :33 Industrial :42	Commercial :34 Industrial :43
Total Thickness	EN ISO 24346	2.20 mm (min:-0.10 mm max: 0.13 mm)	2.50 mm (min:-0.10 mm max: 0.13 mm)	2.50 mm (min:-0.10 mm max: 0.13 mm)	3 mm (min:-0.10 mm max: 0.13 mm)	3 mm (min:-0.10 mm max: 0.13 mm)	4.50 mm (min:-0.10 mm max: 0.13 mm)	4.50 mm (min:-0.10 mm max: 0.13 mm)	5 mm (min:-0.10 mm max: 0.13 mm)	5 mm (min:-0.10 mm max: 0.13 mm)	5 mm (min:-0.10 mm max: 0.13 mm)
Wear Layer Thickness	EN ISO 24340	0.40 mm (max:+%13 min:-%10)	0.55 mm (max:+%13 min:-%10)	0.70 mm (max:+%13 min:-%10)	0.55 mm (max:+%13 min:-%10)	0.70 mm (max:+%13 min:-%10)	0.55 mm (max:+%13 min:-%10)	0.70 mm (max:+%13 min:-%10)	0.30 mm (max:+%13 min:-%10)	0.55 mm (max:+%13 min:-%10)	0.70 mm (max:+%13 min:-%10)
Total Weight	EN ISO 23997	3430 gr/m <sup>2</sup> (max:+%13 min:-%10)	3900 gr/m <sup>2</sup> (max:+%13 min:-%10)	3820 gr/m <sup>2</sup> (max:+%13 min:-%10)	4800 gr/m <sup>2</sup> (max:+%13 min:-%10)	4710 gr/m <sup>2</sup> (max:+%13 min:-%10)	7550 gr/m <sup>2</sup> (max:+%13 min:-%10)	7470 gr/m <sup>2</sup> (max:+%13 min:-%10)	8550 gr/m <sup>2</sup> (max:+%13 min:-%10)	8440 gr/m <sup>2</sup> (max:+%13 min:-%10)	8370 gr/m <sup>2</sup> (max:+%13 min:-%10)
(PURGUARD) /Surface Treatment		Yes	Yes	Yes	Yes	Yes	Yes	Yes	Yes	Yes	Yes
Bevelled Edges		Yes	Yes	Yes	Yes	Yes	Yes	Yes	Yes	Yes	Yes

TECHNICAL PROPERTIES

Abrasion Group	EN 660-2	Group T	Group T	Group T	Group T	Group T	Group T	Group T	Group T	Group T	Group T
Binder Content	ISO 10582	TYPE 1	TYPE 1	TYPE 1	TYPE 1	TYPE 1	TYPE 1	TYPE 1	TYPE 1	TYPE 1	TYPE 1
Dimensional Stability	EN ISO 23999	OK	OK	OK	OK	OK	OK	OK	OK	OK	OK
Residual Indentation	EN ISO 24343-1	0.04 mm	0.05 mm	0.05 mm	0.03 mm	0.04 mm	0.04 mm	0.05 mm	0.04 mm	0.03 mm	0.04 mm
Castor Chair	ISO 4918	No damage	No damage	No damage	No damage	No damage	No damage	No damage	No damage	No damage	No damage
Flexibility	ISO 24344	No Crack	No Crack	No Crack	No Crack	No Crack	No Crack	No Crack	No Crack	No Crack	No Crack
Light Fastness	EN 105-B02	≥6	≥6	≥6	≥6	≥6	≥6	≥6	≥6	≥6	≥6
Stain and Resistance to Chemicals	EN ISO 26987	Ok	Ok	Ok	Ok	Ok	Ok	Ok	Ok	Ok	Ok
Evaluation of the Action of Microorganisms	EN ISO 846 C	0 Does not contribute to bacterial growth	0 Does not contribute to bacterial growth	0 Does not contribute to bacterial growth	0 Does not contribute to bacterial growth	0 Does not contribute to bacterial growth	0 Does not contribute to bacterial growth	0 Does not contribute to bacterial growth	0 Does not contribute to bacterial growth	0 Does not contribute to bacterial growth	0 Does not contribute to bacterial growth
Formaldehyde Emission	EN 717-1	Class E 1	Class E 1	Class E 1	Class E 1	Class E 1	Class E 1	Class E 1	Class E 1	Class E 1	Class E 1
Fire Classification	EN 13501-1	Bfl S1	Bfl S1	Bfl S1	Bfl S1	Bfl S1	Bfl S1	Bfl S1	Bfl S1	Bfl S1	Bfl S1
Electrical Property	EN 1815	≤2kV Antistatic	≤2kV Antistatic	≤2kV Antistatic	≤2kV Antistatic	≤2kV Antistatic	≤2kV Antistatic	≤2kV Antistatic	≤2kV Antistatic	≤2kV Antistatic	≤2kV Antistatic
Thermal Conductivity	EN 12667	0,0423 (m2K)/W	0,0423 (m2K)/W	0,0423 (m2K)/W	0,0423 (m2K)/W	0,0423 (m2K)/W	0,0423 (m2K)/W	0,0423 (m2K)/W	0,0423 (m2K)/W	0,0423 (m2K)/W	0,0423 (m2K)/W
Slip Resistance	EN 13893	DS	DS	DS	DS	DS	DS	DS	DS	DS	DS

FORM OF DELIVERY

SIZE	Pcs in Box										
	30.5 cm X 61 cm	22	19	19	16	16	11	11	10	10	10
61 cm X 61 cm	11	10	10	8	8	5	5	5	5	5	5
45.7 cm X 45.7 cm	20	17	17	14	14	10	10	9	9	9	9
20 cm X 120 cm	16	14	14	12	12	8	8	7	7	7	7
SIZE	m <sup>2</sup> in Box										
	30.5 cm X 61 cm	4,06	3,57	3,57	2,98	2,98	1,98	1,98	1,79	1,79	1,79
61 cm X 61 cm	4,06	3,57	3,57	2,98	2,98	1,98	1,98	1,79	1,79	1,79	
45.7 cm X 45.7 cm	4,08	3,59	3,59	2,99	2,99	2	2	1,8	1,8	1,8	
20 cm X 120 cm	3,82	3,36	3,36	2,8	2,8	1,87	1,87	1,68	1,68	1,68	
SIZE	Net Weight in Box (kg)										
	30.5 cm X 61 cm	13,92	13,92	13,63	14,3	14,03	14,94	14,79	15,3	15,1	14,98
61 cm X 61 cm	13,92	13,92	13,63	14,3	14,03	14,94	14,79	15,3	15,1	14,98	
45.7 cm X 45.7 cm	13,99	14	13,71	14,35	14,08	15,1	14,94	15,39	15,19	15,06	
20 cm X 120 cm	13,1	13,1	12,83	13,44	13,18	14,11	13,96	14,36	14,17	14,06	

\* Sipariş geçmeden önce, lütfen güncel TDS verilerini talep edin.

\* Before placing an order, please request up-to-date TDS data.



EICHE ( 610 / 611 )



SMOOTH ( 465 )



\*\* Real products may differ from above images. Please kindly note to ask for real products samples before confirming your order.

\*\* Gerçek ürünler yukarıdaki resimlerden farklı olabilir. Lütfen siparişinizi vermeden önce gerçek ürün numunelerini istemeyi unutmayın.

\*\* Реальные продукты могут отличаться от изображений выше. Пожалуйста, обратите внимание, чтобы запросить образцы реальной продукции перед подтверждением вашего заказа.

# [N-LVT]

Luxury Vinyl Tile

Lüks Vinil Karo

Роскошная виниловая  
плитка

## STONETTE ( A00 )

A00 000

A00 100

A00 200

A00 300

A00 400

## BETONIST ( 210 )

210 000

210 100

210 200

210 300

210 400

## SHADY ( 375 )

375 100

375 200

375 300

375 400

375 500

375 600

375 700

375 800



SafeFlex

Vinyl Solutions for  
Wet Floors

Islak Zeminler İçin  
Vinil Çözümler

Виниловые решения для  
Мокрые полы

SafeFlex



net  
FLOOR COVERINGS  
www.netfloor.com.tr



## Vinyl Solutions for Wet Floors



## Islak Zeminler İçin Vinil Çözümler



## Виниловые решения для Мокрые полы



- Is produced for low-weight solutions in wet areas
- Supplies high anti-slippery with its R10 slippery class.
- Convenient for buildings with its Bfl S1 fire-class.
- Convenient for using in portable containers.
- Recommended to install with polyurathane based adhesives in self returning pool applications.
- Is an environment friendly covering that does not include Phthalates.

- Islak mekânlarda hafif çözümler için üretilmiştir.
- R10 kayma sınıfı ile yüksek kaymazlık sağlar.
- Bfl S1 yanmazlık sınıfı ile binalara uygundur.
- Dönüştürülebilir uygulama ve poliüretan esaslı yapıştırıcılarla uygulaması önerilir.
- Fitalat içermeyen çevre dostu bir kaplama.
- Hareketli konteynerlerde kullanımı uygundur.

- Предназначен для устройства облегченных покрытий во влажных помещениях.
- Высокий класс сопротивления скольжению R10 – нескользящее покрытие.
- Пригоден для применения в зданиях благодаря классу огнеупорности Bfl S1.
- Рекомендуется применение клеев на основе полиуретана и метода свободного настила покрытия.
- Экологически чистое покрытие не содержащее фталатов
- Пригоден для применения в передвижных контейнерах.



## Layer Diagrams



## Katman Şemaları



## Диаграммы слоев

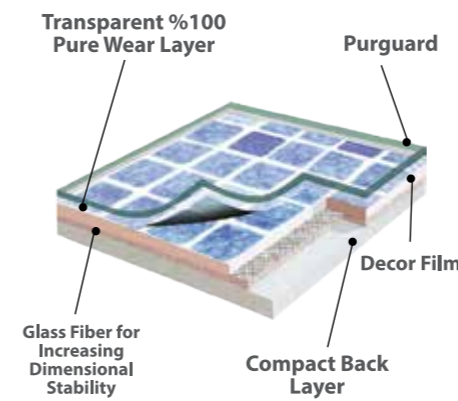

"Some products may use a different product architecture than the illustration above."

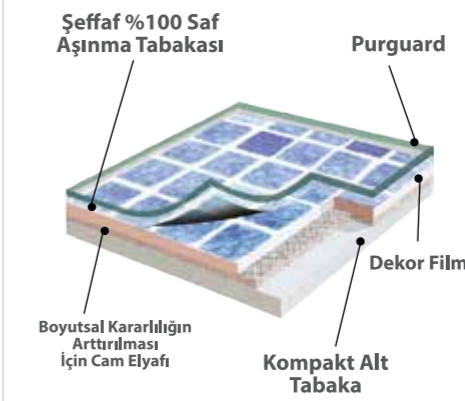

"Kimi ürünlerde, yukarıdaki gösterimden farklı ürün mimarisi kullanılabilir."

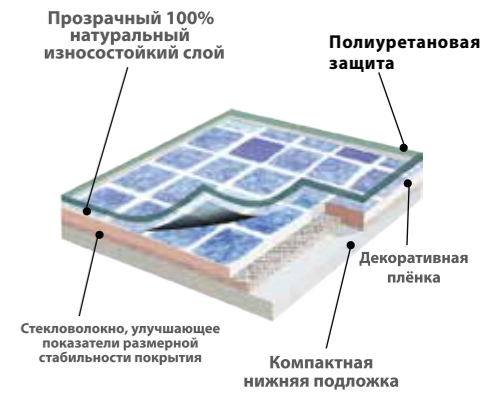

"Некоторые продукты могут использовать архитектуру продукта, отличную от той, что показана на рисунке выше."



GLASS FIBER TISSUE : OK  
PURGUARD : OK

## TECHNICAL DATA SHEET

PRODUCT IDENTIFICATION : SAFEFLEX 2 mm - 0.40 mm

## TECHNICAL PROPERTIES

SPECIFICATION	STANDARD	PRODUCT	
Usage Class	EN ISO 10874	Commercial: 32 Industrial: 41	Commercial: 33 Industrial: 42
Total Thickness	EN ISO 24346	2 mm (min:-0.10 mm max: 0.13 mm)	2.50 mm (min:-0.10 mm max: 0.13 mm)
Wear Layer Thickness	EN ISO 24340	0.40 mm (max:+%13 min: -%10)	0.55 mm (max:+%13 min: -%10)
Total Weight	EN ISO 23997	2900 g/m <sup>2</sup> (max:+%13 min: -%10)	3650 g/m <sup>2</sup> (max:+%13 min: -%10)
Roll Width	EN ISO 24341	2 m	2 m
Roll Length	EN ISO 24341	20 m	20 m
PERFORMANCE			
Wear Layer Group	EN 660-2	GROUP T	GROUP T
Binder Content	ISO 10582	TYPE 1	TYPE 1
Effect of a Castor Chair	ISO 4918	No deformation after 25.000 cycles	No deformation after 25.000 cycles
Test for Color Fastness	EN ISO 105-B02	≥6	≥6
Dimensional Stability	EN ISO 23999	≤%0.4	≤%0.4
Curling	EN ISO 23999	Max:8 mm	Max:8 mm
Residual Indentation	EN ISO 24343-1	≤0.1 mm	≤0.1 mm
Determination of Staining and Resistance to Chemicals	EN ISO 26987	Ok	Ok
Seam Strength	EN 684	≥240 N/50 mm	≥240 N/50 mm
Flexibility	EN ISO 24344	No Crack	No Crack
Evaluation of the Action of Microorganisms	EN ISO 846 C	0 Does not contribute to bacterial growth	0 Does not contribute to bacterial growth
Formaldehyde Emission	EN 717-1	Class E 1	Class E 1
Fire Classification	EN 13501-1	Bfl S1	Bfl S1
Electrical Property	EN 1815	≤2kV Antistatic	≤2kV Antistatic
Thermal Conductivity	EN 12667	0,0423 (m <sup>2</sup> K)/W	0,0423 (m <sup>2</sup> K)/W
Slip Resistance	EN 13893	DS	DS
	EN 16165	R10 (R11 Optional)	R10 (R11 Optional)

\* Sipariş geçmeden önce, lütfen güncel TDS verilerini talep edin.

\* Before placing an order, please request up-to-date TDS data.

## HYDRO ( 960 )

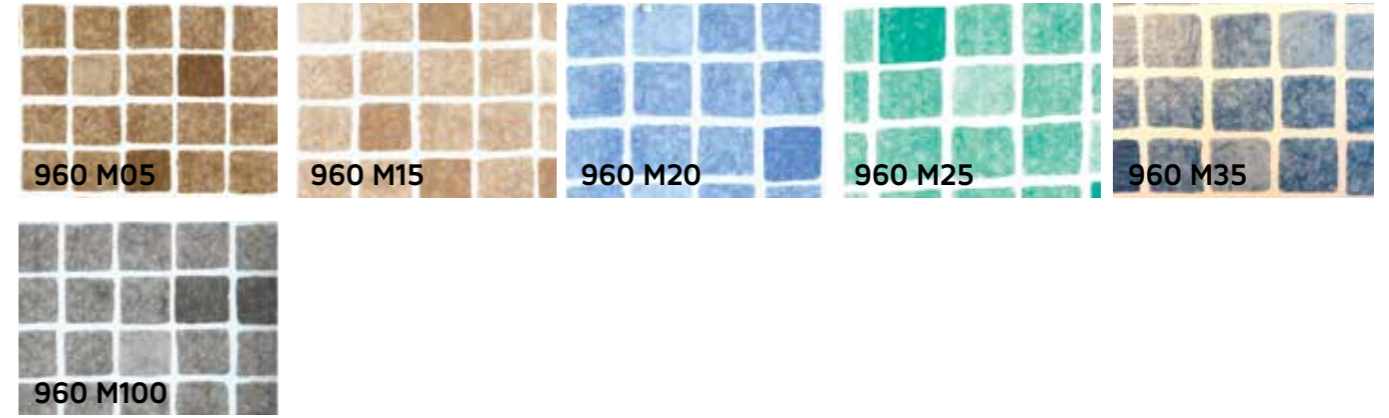

## ROMAN ( 370 )



## MARMARON ( 460 )

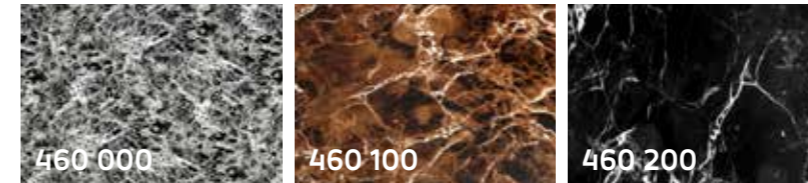

## BETONIST 22 ( 210 )



\*\* Real products may differ from above images. Please kindly note to ask for real products samples before confirming your order.

\*\* Gerçek ürünler yukarıdaki resimlerden farklı olabilir. Lütfen siparişinizi vermeden önce gerçek ürün numunelerini istemeyi unutmayın.

\*\* Реальные продукты могут отличаться от изображений выше. Пожалуйста, обратите внимание, чтобы запросить образцы реальной продукции перед подтверждением вашего заказа.

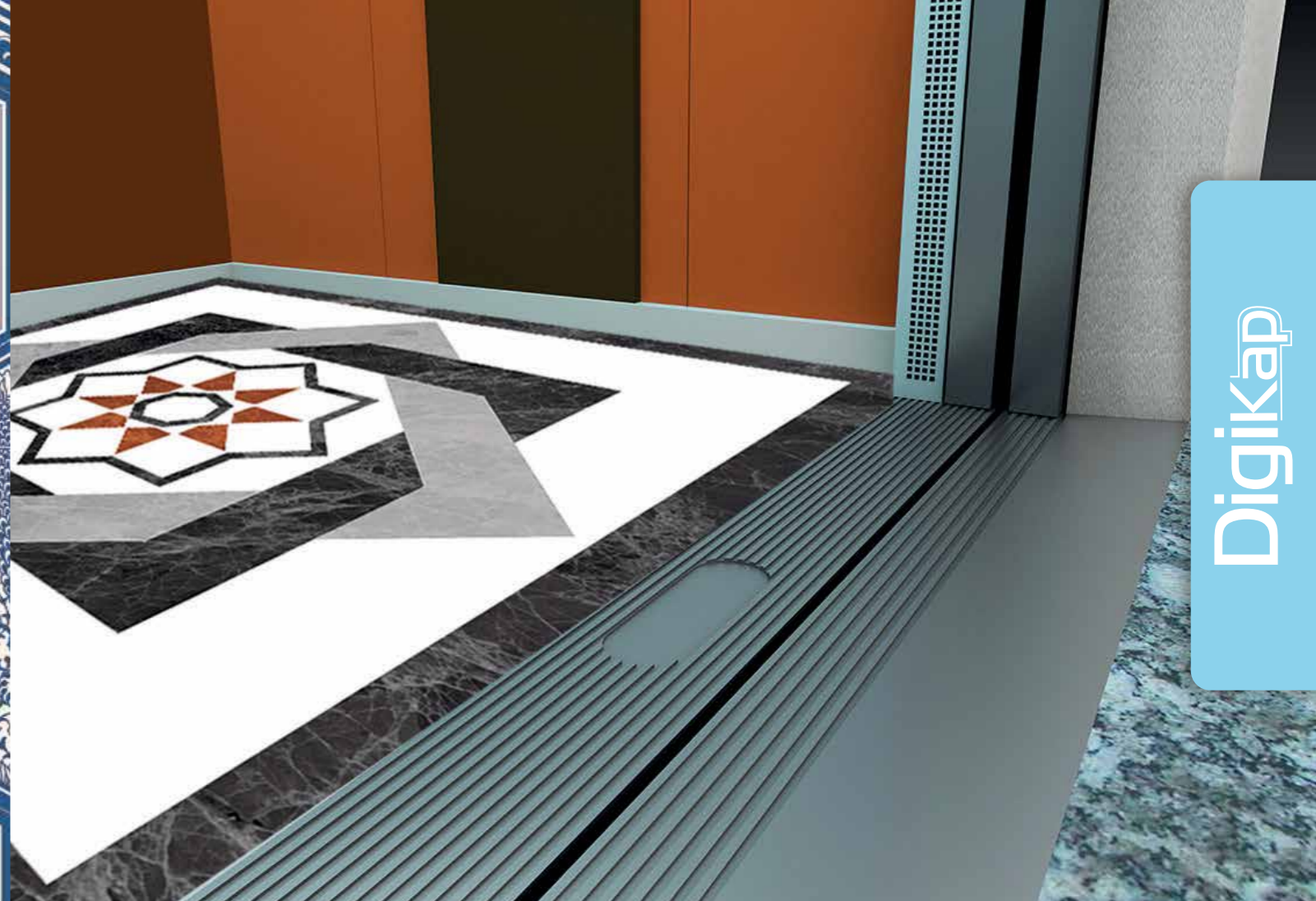

Digikap

Coverings With Digital  
Printed Images

Dijital Baskılı  
Kaplamarlar

покрытия с цифровой  
печатью

DigiKap



**net**  
FLOOR COVERINGS  
[www.netfloor.com.tr](http://www.netfloor.com.tr)



## Coverings With Digital Printed Images



## Dijital Baskılı Kaplamalar



## покрытия с цифровой печатью

### New generation of solutions for your commercial areas!

Would you like to integrate flexibility, weightlessness, resistance and chemically adopted superior qualities of vinyl materials to aesthetics of traditional design materials or even challenges of bright new design ideas?

#### For the ones who are in search of difference!

Imagine schools, hospital or life areas with vinyl floorings having the visual varieties of lighter granites, easy-to-mob weavings, unbreakable stained glasses or antimicrobial mosaics. Would you like to try untired?

#### For the ones who desire the bright new!

For the ones who desire the bright new! What if you like to work with visuals in your own concept? You are only limited with visual variability of digital printing technology!

#### For the ones who desire to handle functional solutions with economic advantage in commercial areas!

You can use mosaic, granite, weaving, stained glass designs with price advantage of vinyl materials in your commercial areas with related EN floor covering norms.

You can find a few examples of new generation of vinyl floorings below. Please note that these visuals have been chosen just to present a general idea. Please remember that you can use all visuals limited by technical and legal borders, in your floor coverings.

### Ticari mekan tasarımlarınızda yeni nesil çözümler!

Vinil malzemelerin esneklik, hafiflik, dayanım, kaydırmazlık ve kimyasal olarak üstün niteliklerini geleneksel tasarım malzemelerinin estetiğiyle veya yepyeni tasarım fikirlerinin meydan okuyuculuğuyla birleştirmek ister misiniz?

#### Mekânlarınızda farklılık yaratmak isteyenlere!

Hafifletilmiş granitler, silinebilir dokumalar, kırılmaz vitraylar veya antimikrobiyel mozaiklerin görsel çeşitliliğine sahip vinil zemin kaplamaları ile döşenmiş okullar, hastaneler, yaşam sahaları hayal edin. Denenmemişi denemek ister misiniz?

#### Yepyeni arzu edenlere!

Peki ya tamamen kendi konseptinizdeki görsellerle çalışmak ister misiniz? Sadece dijital baskı teknolojisinin sonsuz görsel çeşitliliği ile sınırlı değilsiniz!

#### Ticari mekânlarınızda fonksiyonel çözümlerle ekonomik avantajla elde etmek isteyenler!

Mozaik, granit, dokuma, vitray tasarımlarını vinil malzemelerin fiyat avantajlarıyla ticari mekânlarınızın zeminlerinde, ilgili EN zemin kaplama normlarında kullanabilirsiniz.

Farklılaştırılmış yeni nesil ticari vinil zemin kaplamalarına birkaç örneğini aşağıda bulabilirsiniz. Bu görsellerin sadece sizlere fikir vermek için seçilmiştir. Yasal ve teknik limitlerle sınırlı olmak üzere istediğiniz tüm görsellerin zemin kaplamalarınızda kullanılabilirliğini hatırlayınız.

### Декоративные решения нового поколения в области дизайна интерьеров коммерческих помещений!

Хотите объединить эластичность, легкость, прочность, низкое скольжение и превосходные качества, обусловленные химическим составом виниловых материалов, с эстетичностью традиционных декоративных материалов? Или может быть с их помощью воплотить в жизнь совершенно новые идеи и бросить вызов классике?

#### Для тех, кто хочет выделить свое помещение на общем фоне!

Представьте себе школы, клиники, жизненные пространства, пол в которых выстлан виниловым покрытием разнообразных фактур: облегченный гранит, моющиеся полотна ткани, небьющейся витраж, противомикробная мозаика. Хотите попробовать что-то ранее неиспытанное?

#### Стремящимся к новизне!

А хотелось бы Вам работать с материалами, безупречно сочетающимися визуально с Вашей личной концепцией декора? Тогда представьте, что Вы ограничены всего лишь бесконечным числом визуальных вариантов цифровых печатных технологий!

#### Для тех, кто желает сочетать функциональные решения для коммерческих помещений с экономическими преимуществами!

Уникальная возможность воплотить в реальности дизайны мозаичного, гранитного, тканевого и витражного напольного покрытия коммерческих помещений, благодаря виниловым материалам: выгодная цена и соответствие нормам напольного покрытия EN.

Ниже представлены варианты напольных покрытий, выполненных из специализированных виниловых материалов нового поколения для коммерческих помещений. Эти варианты выбраны исключительно с целью подать Вам идею. Помните, что Вы можете использовать любые модели декорирования напольного покрытия при условии соблюдения соответствующих законных и технических норм.

## Specifications

## Özellikler

## Характеристики

GLASS FIBER TISSUE : OK  
PURGUARD : OK

### TECHNICAL DATA SHEET

#### PRODUCT IDENTIFICATION : DIGIKAP

#### TECHNICAL PROPERTIES

SPECIFICATION	STANDARD	PRODUCT		
Usage Class	EN ISO 10874	Commercial: 32 Industrial: 41	Commercial: 34 Industrial: 43	Commercial: 34 Industrial: 43
Total Thickness	EN ISO 24346	2 mm (min:-0.10 mm max: 0.13 mm)	2 mm (min:-0.10 mm max: 0.13 mm)	3 mm (min:-0.10 mm max: 0.13 mm)
Wear Layer Thickness	EN ISO 24340	0.40 mm (max:+%13 min: -%10)	0.70 mm (max:+%13 min: -%10)	0.70 mm (max:+%13 min: -%10)
Total Weight	EN ISO 23997	3050 g/m <sup>2</sup> (max:+%13 min: -%10)	2950 g/m <sup>2</sup> (max:+%13 min: -%10)	4400 g/m <sup>2</sup> (max:+%13 min: -%10)
Roll Width	EN ISO 24341	2 m	2 m	2 m
Roll Length	EN ISO 24341	20 m	20 m	20 m
PERFORMANCE				
Wear Layer Group	EN 660-2	GROUP T	GROUP T	GROUP T
Binder Content	ISO 10582	TYPE 1	TYPE 1	TYPE 1
Effect of a Castor Chair	ISO 4918	No deformation after 25.000 cycles	No deformation after 25.000 cycles	No deformation after 25.000 cycles
Test for Color Fastness	EN ISO 105-B02	≥6	≥6	≥6
Dimensional Stability	EN ISO 23999	≤%0.4	≤%0.4	≤%0.4
Curling	EN ISO 23999	Max:8 mm	Max:8 mm	Max:8 mm
Residual Indentation	EN ISO 24343-1	≤0.1 mm	≤0.1 mm	≤0.1 mm
Determination of Staining and Resistance to Chemicals	EN ISO 26987	Ok	Ok	Ok
Seam Strength	EN 684	≥240 N/50 mm	≥240 N/50 mm	≥240 N/50 mm
Flexibility	EN ISO 24344	No Crack	No Crack	No Crack
Evaluation of the Action of Microorganisms	EN ISO 846 C	Does not contribute to bacterial growth	Does not contribute to bacterial growth	Does not contribute to bacterial growth
Formaldehyde Emission	EN 717-1	Class E 1	Class E 1	Class E 1
Fire Classification	EN 13501-1	Bfl S1	Bfl S1	Bfl S1
Electrical Property	EN 1815	≤2kV Antistatic	≤2kV Antistatic	≤2kV Antistatic
Thermal Conductivity	EN 12667	0,0423 (m2K)/W	0,0423 (m2K)/W	0,0423 (m2K)/W
Slip Resistance	EN 13893	DS	DS	DS

\* Sipariş geçmeden önce, lütfen güncel TDS verilerini talep edin.

\* Before placing an order, please request up-to-date TDS data.



Coverings With Digital  
Printed Images

Dijital Baskılı Kaplamalar

ПОКРЫТИЯ С ЦИФРОВОЙ  
ПЕЧАТЬЮ

## GRANIT



## MOZAİK



\*\* Real products may differ from above images. Please kindly note to ask for real products samples before confirming your order.

\*\* Gerçek ürünler yukarıdaki resimlerden farklı olabilir. Lütfen siparişinizi vermeden önce gerçek ürün numunelerini istemeyi unutmayın.

\*\* Реальные продукты могут отличаться от изображений выше. Пожалуйста, обратите внимание, чтобы запросить образцы реальной продукции перед подтверждением вашего заказа.

Coverings With Digital  
Printed Images

Dijital Baskılı Kaplamalar

ПОКРЫТИЯ С ЦИФРОВОЙ  
ПЕЧАТЬЮ

## MOZAİK



## GRAFİK

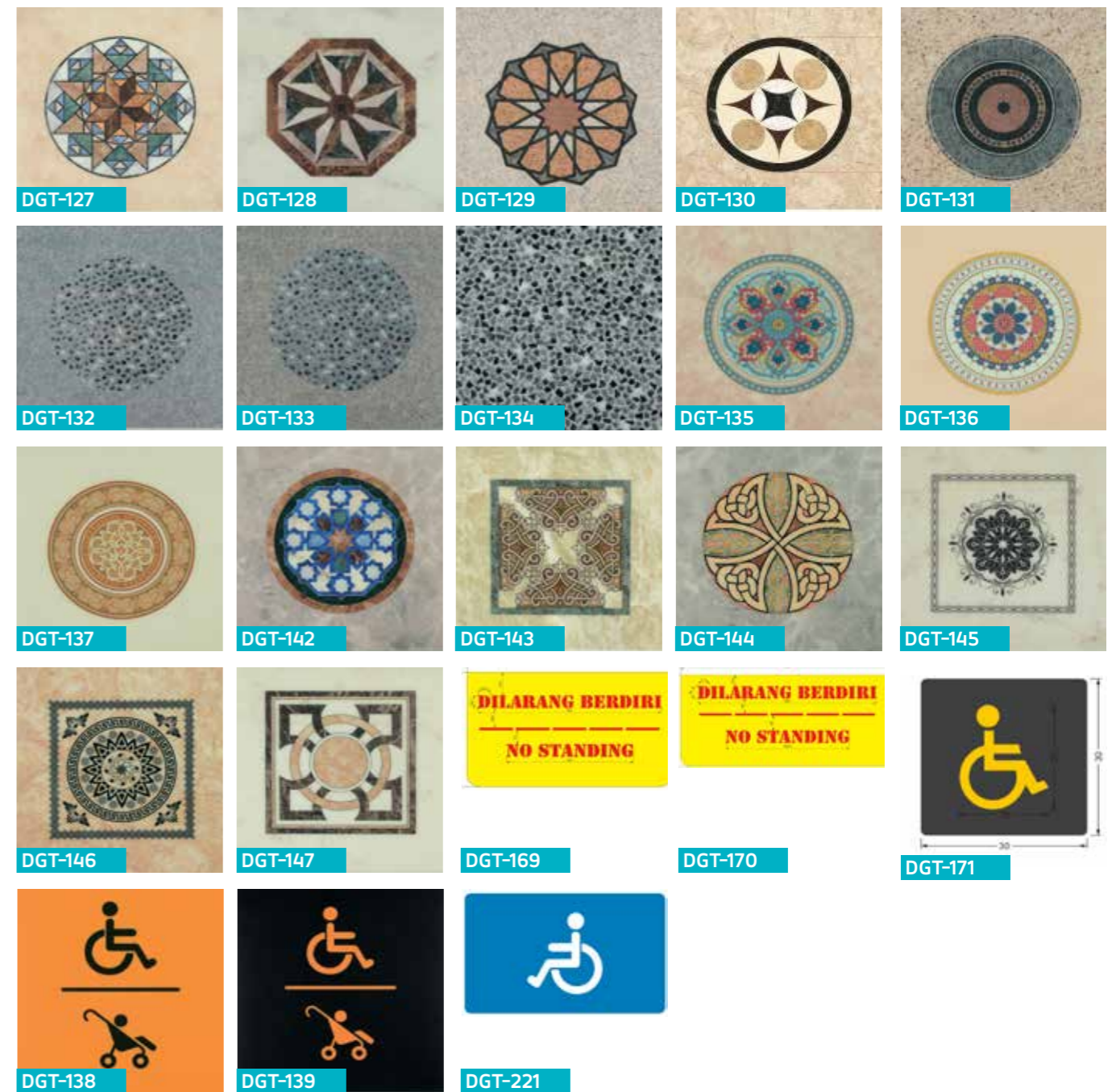

\*\* Real products may differ from above images. Please kindly note to ask for real products samples before confirming your order.

\*\* Gerçek ürünler yukarıdaki resimlerden farklı olabilir. Lütfen siparişinizi vermeden önce gerçek ürün numunelerini istemeyi unutmayın.

\*\* Реальные продукты могут отличаться от изображений выше. Пожалуйста, обратите внимание, чтобы запросить образцы реальной продукции перед подтверждением вашего заказа.

Coverings With Digital  
Printed Images

Dijital Baskılı Kaplamalar

ПОКРЫТИЯ С ЦИФРОВОЙ  
ПЕЧАТЬЮ

## GRAFİK

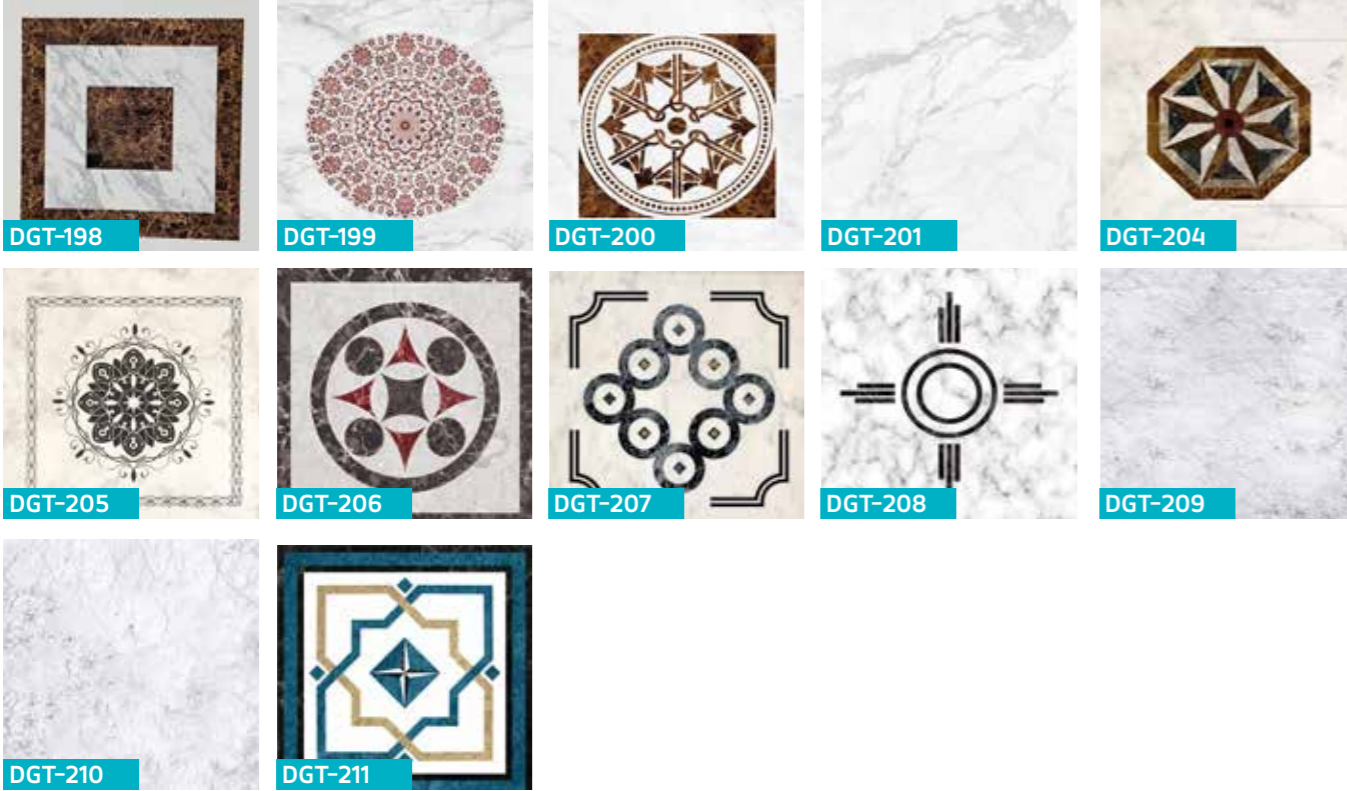

## HALI



\*\* Real products may differ from above images. Please kindly note to ask for real products samples before confirming your order.

\*\* Gerçek ürünler yukarıdaki resimlerden farklı olabilir. Lütfen siparişinizi vermeden önce gerçek ürün numunelerini istemeyi unutmayın.

\*\* Реальные продукты могут отличаться от изображений выше. Пожалуйста, обратите внимание, чтобы запросить образцы реальной продукции перед подтверждением вашего заказа.

Coverings With Digital  
Printed Images

Dijital Baskılı Kaplamalar

ПОКРЫТИЯ С ЦИФРОВОЙ  
ПЕЧАТЬЮ

## ARABESK



## FOTOĞRAF

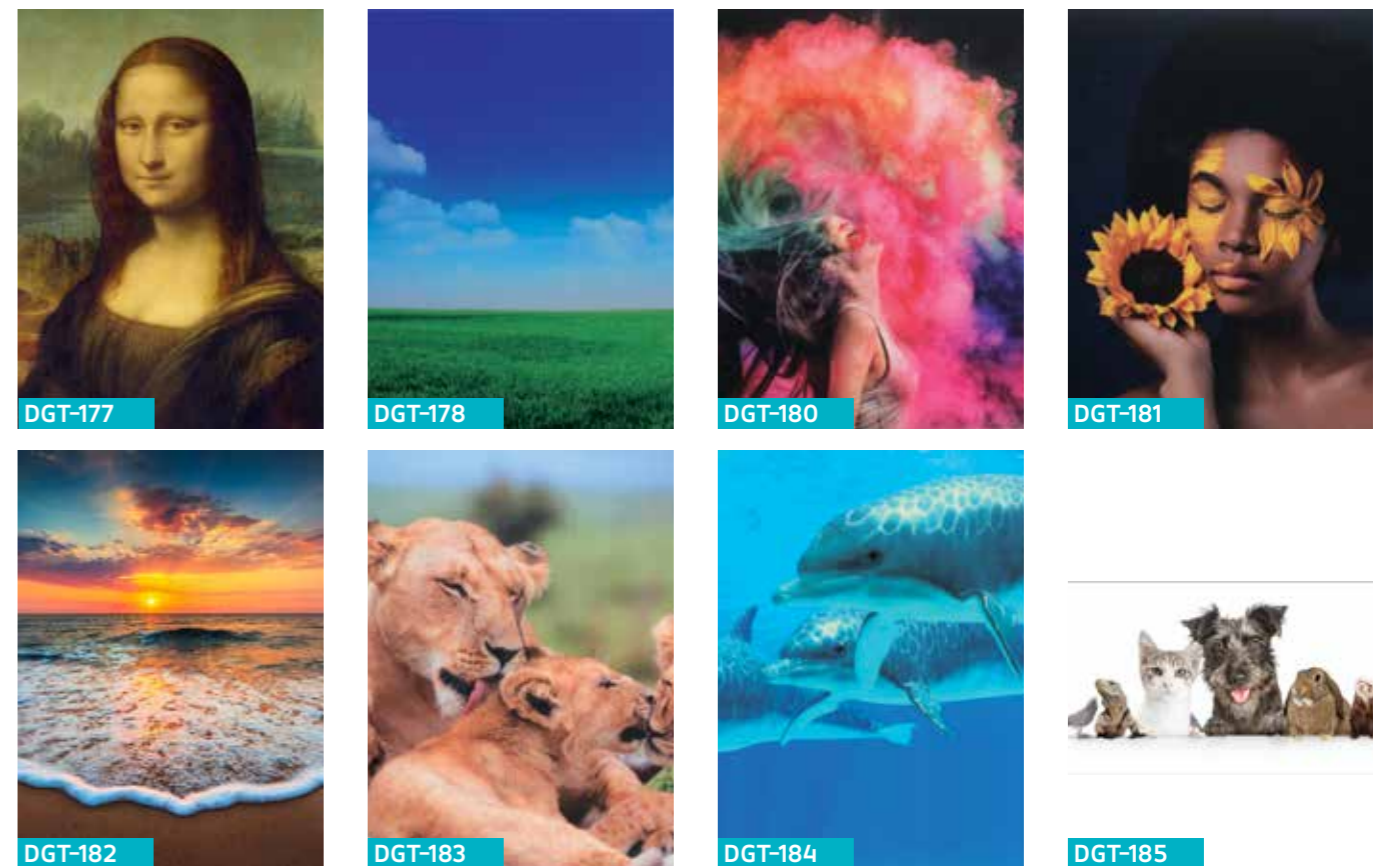

\*\* Real products may differ from above images. Please kindly note to ask for real products samples before confirming your order.

\*\* Gerçek ürünler yukarıdaki resimlerden farklı olabilir. Lütfen siparişinizi vermeden önce gerçek ürün numunelerini istemeyi unutmayın.

\*\* Реальные продукты могут отличаться от изображений выше. Пожалуйста, обратите внимание, чтобы запросить образцы реальной продукции перед подтверждением вашего заказа.



HomeFlex

Multi-Layered  
Compact Vinyl Flooring

Çok Katmanlı  
Kompakt Vinil Döşeme

Многослойный Компактный  
Виниловый Пол

HomeFlex



net  
FLOOR COVERINGS  
www.netfloor.com.tr



## Heterogeneous Contract Floor Coverings



## Heterojen Kontrat Zemin Kaplamaları



## КоНтраКТНhle rereporeННhle HanonbHhle noKpbITИ/ИH



- It is produced using virgin raw materials.
- No recycled raw materials are used in its production.
- It is 100% recyclable.
- It does not contribute to bacterial growth. By this means, it helps prevent the spread of microorganisms.
- The reinforced product architecture neutralizes surface defects caused by the sub-floor.
- It provides good sound and heat insulation in your space with its strong product architecture with textile support.
- Thanks to its flexible structure, it is easy to be floored.
- All HomeFlex options are suitable for damp cleaning (mob-cleaning).
- It has a wide range of applications with a rich pattern and color spectrum.
- As a T-Class and Type 1 floor covering, it is a long-lasting domestic floor covering with exceptional wear resistance.
- It provides superior comfort when pressed thanks to the textile reinforcement.
- It is applied to the entire surface using water-based adhesive.

- Virgin hammaddeler kullanılarak üretilir.
- Üretiminde geri dönüştürülmüş hammaddede içermez.
- %100 geri dönüştürülebilir.
- Bakteriyel çoğalmaya katkıda bulunmaz. Bu sayede mikroorganizmaların yayılmasını engellemeye yardımcı olur.
- Kuvvetlendirilmiş ürün mimarisi alt zeminden kaynaklı yüzey hatalarını etkisizleştirir.
- Tekstil destekli güçlü ürün mimarisi ile mekânınızda iyi bir ses ve ısı izolasyonu sağlar.
- Esnek yapısı sayesinde uygulaması kolaydır.
- Tüm HomeFlex seçenekleri, nemli temizlik için uygundur.
- Zengin desen ve renk spektrumu ile geniş bir uygulama yelpazesine sahiptir.
- T Sınıf ve tip 1 zemin kaplaması olarak fevkalade bir aşınma direncine sahip uzun ömürlü bir evsel zemin döşemesidir.
- Tekstil takviyesi ile mükemmel bir yürüme konforu sağlar.
- Tüm yüzeye su bazlı yapıştırıcı kullanılarak uygulanır.

- Изготавливается только с использованием первичного сырья.
- Не содержит переработанных материалов в своем производстве.
- На 100% перерабатываемый продукт.
- Не способствует размножению микробов. Благодаря чему предупреждает размножение микроорганизмов.
- Усиленная архитектура продукта нейтрализует поверхностные дефекты, формирующиеся в нижнем основании.
- Благодаря усиленной, основанной на текстильной структуре архитектуре продукта, он обеспечит отличную звуковую и тепловую изоляцию в вашем помещении.
- Гибкая структура способствует легкой укладке.
- Все варианты HomeFlex подходят для влажной уборки помещения.
- Благодаря широкой гамме узоров и цветов продукт имеет очень широкий спектр применений.
- Напольное покрытие класса Т и типа 1 является долговечным бытовым напольным покрытием с превосходной стойкостью к истиранию.
- Обеспечивает превосходный комфорт при ходьбе благодаря текстильному армированию.
- Применяется посредством нанесения клея на водной основе на всю поверхность покрытия.



## Layer Diagrams



## Katman Şemaları



## Диаграммы слоев

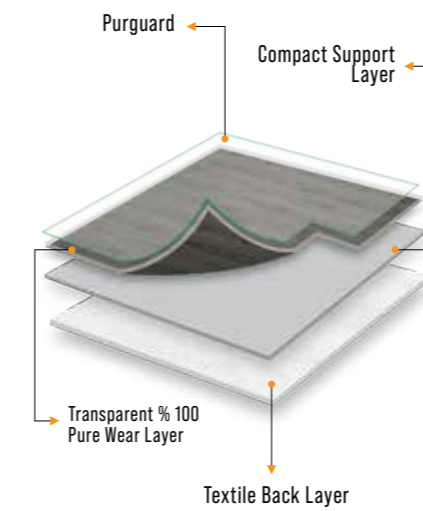

"Some products may use a different product architecture than the illustration above."

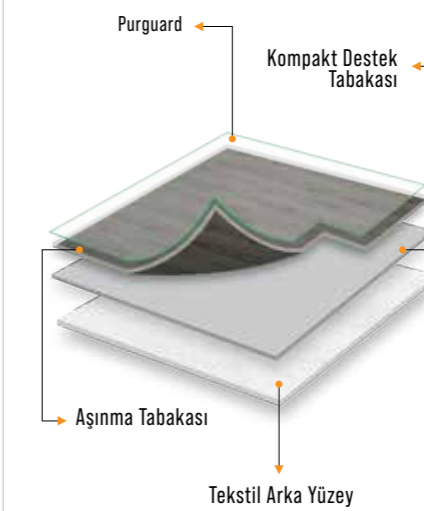

"Kimi ürünlerde, yukarıdaki gösterimden farklı ürün mimarisi kullanılabilir."

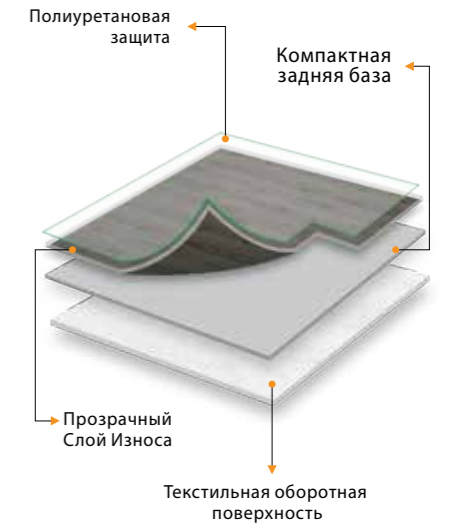

" Некоторые продукты могут использовать архитектуру продукта, отличную от той, что показана на рисунке выше."



Specifications		Özellikler		Характеристики	
<b>TECHNICAL DATA SHEET</b>					
				RECYCLED PVC : NO PURGUARD : OK TSE : OK	RECYCLED PVC : NO ECOSHELL : OK TSE : NO
<b>SPECIFICATION</b>	<b>STANDARD</b>	<b>HomeFlex</b>		<b>HomeFlex LITE</b>	
<b>Usage Class</b>	<b>EN ISO 10874</b>	Domestic : 21	Domestic : 22	Commercial : 32 Industrial : 41	
<b>Total Thickness</b>	<b>EN ISO 24346</b>	2 mm (min:-0.15 mm max: 0.18 mm)	2.50 mm (min:-0.15 mm max: 0.18 mm)	3 mm (min:-0.15 mm max: 0.18 mm)	2 mm (min:-0.15 mm max: 0.18 mm)
<b>Wear Layer Thickness</b>	<b>EN ISO 24340</b>	0.15 mm (max:+%13 min: -%10)	0.20 mm (max:+%13 min: -%10)	0.35 mm (max:+%13 min: -%10)	
<b>Total Weight</b>	<b>EN ISO 23997</b>	1345 g/m <sup>2</sup> (max:+%13 min: -%10)	2255 g/m <sup>2</sup> (max:+%13 min: -%10)	2950 g/m <sup>2</sup> (max:+%13 min: -%10)	1500 g/m <sup>2</sup> (max:+%13 min: -%10)
<b>Roll Width</b>	<b>EN ISO 24341</b>	2 m	2 m	2 m	2 m
<b>Roll Length</b>	<b>EN ISO 24341</b>	25-35 m	25-35 m	25-35 m	30 m
<b>PERFORMANCE</b>					
<b>Back Layer</b>		TX300S	TX300S	TX300S	TX300S
<b>Wear Layer Group</b>	<b>EN 660-2</b>	Group T	Group T	Group T	
<b>Binder Content</b>	<b>ISO 10582</b>	Type 1	Type 1	Type 1	
<b>Effect of a Castor Chair</b>	<b>EN ISO 4918</b>	No deformation after 25.000 cycles	No deformation after 25.000 cycles	No deformation after 25.000 cycles	
<b>Determination of the Simulated Movement of Furniture Leg</b>	<b>EN ISO 16581</b>	N/A	N/A	N/A	
<b>Test for Color Fastness</b>	<b>EN ISO 105-B02</b>	≥6	≥6	≥6	
<b>Dimensional Stability</b>	<b>EN ISO 23999</b>	≤%0.4	≤%0.4	≤%0.4	
<b>Curling</b>	<b>EN ISO 23999</b>	≤ 8mm	≤ 8mm	≤ 8mm	
<b>Residual Indentation</b>	<b>EN ISO 24343-1</b>	≤0.10 mm	≤0.10 mm	≤0.10 mm	
<b>Seam Strength</b>	<b>EN 684</b>	≥240 N/50 mm	≥240 N/50 mm	≥240 N/50 mm	
<b>Flexibility</b>	<b>EN ISO 24344</b>	No Crack	No Crack	No Crack	No Crack
<b>"Underfoot Comfort Indentation after Static Loading"</b>	<b>EN ISO 23999</b>	≥0.40 mm	≥0.40 mm	≥0.40 mm	
<b>Peel Resistance</b>	<b>EN ISO 24345</b>	≥70N/50 mm	≥70N/50 mm	≥70N/50 mm	
<b>Evaluation of the Action of Microorganisms</b>	<b>EN ISO 846 C</b>	0 Does not contribute to bacterial growth	0 Does not contribute to bacterial growth	0 Does not contribute to bacterial growth	
<b>Fire Classification</b>	<b>EN 13501-1</b>	Bfl S1	Bfl S1	Bfl S1	
<b>Electrical Property</b>	<b>EN 1815</b>	≤2 kV Antistatic	≤2 kV Antistatic	≤2 kV Antistatic	
<b>Thermal Conductivity</b>	<b>EN 12667</b>	0,0423 (m2K)/W	0,0423 (m2K)/W	0,0423 (m2K)/W	
<b>Slip Resistance</b>	<b>EN 13893</b>	DS	DS	DS	
<b>Tensile Strength Crosswise</b>	<b>EN ISO 527</b>	Min: 3 N/mm <sup>2</sup>	Min: 3 N/mm <sup>2</sup>	Min: 3 N/mm <sup>2</sup>	Min: 3 N/mm <sup>2</sup>
<b>Tensile Strength Lengthwise</b>	<b>EN ISO 527</b>	Min: 3 N/mm <sup>2</sup>	Min: 3 N/mm <sup>2</sup>	Min: 3 N/mm <sup>2</sup>	Min: 3 N/mm <sup>2</sup>

\* Sipariş geçmeden önce, lütfen güncel TDS verilerini talep edin.

\* Before placing an order, please request up-to-date TDS data.



www.netfloor.com.tr

Multi-Layered Vinyl Flooring

Çok Katmanlı Vinil Döşeme

Многослойный виниловый пол

## TRADITION ( 330 / 331 / 332 )



## MUNDI ( 296 / 297 )



\*\* Real products may differ from above images. Please kindly note to ask for real products samples before confirming your order.

\*\* Gerçek ürünler yukarıdaki resimlerden farklı olabilir. Lütfen siparişinizi vermeden önce gerçek ürün numunelerini istemeyi unutmayın.

\*\* Реальные продукты могут отличаться от изображений выше. Пожалуйста, обратите внимание, чтобы запросить образцы реальной продукции перед подтверждением вашего заказа.

Multi-Layered Vinyl Flooring

Çok Katmanlı Vinil Döşeme

Многослойный виниловый пол

## GAIA ( 100 / 101 )

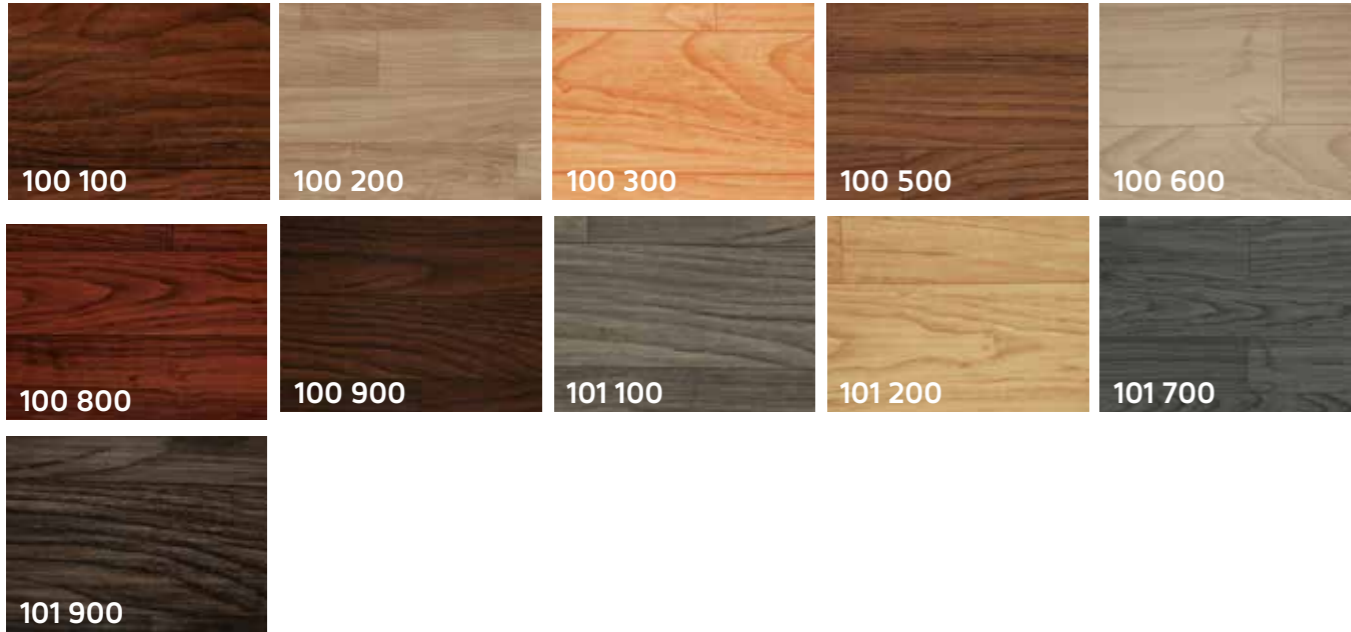

## PORTO ( 620 )



## HEELPAD ( 700 )



\*\* Real products may differ from above images. Please kindly note to ask for real products samples before confirming your order.

\*\* Gerçek ürünler yukarıdaki resimlerden farklı olabilir. Lütfen siparişinizi vermeden önce gerçek ürün numunelerini istemeyi unutmayın.

\*\* Реальные продукты могут отличаться от изображений выше. Пожалуйста, обратите внимание, чтобы запросить образцы реальной продукции перед подтверждением вашего заказа.

Multi-Layered Vinyl Flooring

Çok Katmanlı Vinil Döşeme

Многослойный виниловый пол

## TAPIS ( 470 )



## MODERNO ( 111 )

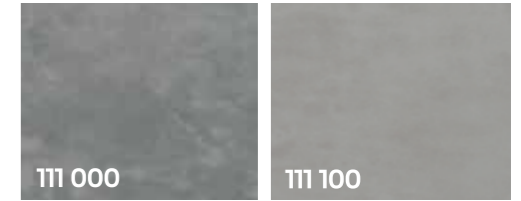

## BETONIST ( 210 )



## VEGA ( 891 )



## STONETTE ( A00 )



\*\* Real products may differ from above images. Please kindly note to ask for real products samples before confirming your order.

\*\* Gerçek ürünler yukarıdaki resimlerden farklı olabilir. Lütfen siparişinizi vermeden önce gerçek ürün numunelerini istemeyi unutmayın.

\*\* Реальные продукты могут отличаться от изображений выше. Пожалуйста, обратите внимание, чтобы запросить образцы реальной продукции перед подтверждением вашего заказа.

Multi-Layered Vinyl Flooring

Çok Katmanlı Vinil Döşeme

Многослойный виниловый пол

## PLAYER ( A30 )



## CHECKER ( A40 )



## HAMMAM (640)



\*\* Real products may differ from above images. Please kindly note to ask for real products samples before confirming your order.

\*\* Gerçek ürünler yukarıdaki resimlerden farklı olabilir. Lütfen siparişinizi vermeden önce gerçek ürün numunelerini istemeyi unutmayın.

\*\* Реальные продукты могут отличаться от изображений выше. Пожалуйста, обратите внимание, чтобы запросить образцы реальной продукции перед подтверждением вашего заказа.

Multi-Layered Vinyl Flooring

Çok Katmanlı Vinil Döşeme

Многослойный виниловый пол

## TRADITION ( 330 / 331 / 332 )



## MUNDI ( 296 / 297 )



\*\* Real products may differ from above images. Please kindly note to ask for real products samples before confirming your order.

\*\* Gerçek ürünler yukarıdaki resimlerden farklı olabilir. Lütfen siparişinizi vermeden önce gerçek ürün numunelerini istemeyi unutmayın.

\*\* Реальные продукты могут отличаться от изображений выше. Пожалуйста, обратите внимание, чтобы запросить образцы реальной продукции перед подтверждением вашего заказа.

Multi-Layered Vinyl Flooring

Çok Katmanlı Vinil Döşeme

Многослойный виниловый пол

## GAIA ( 100 / 101 )

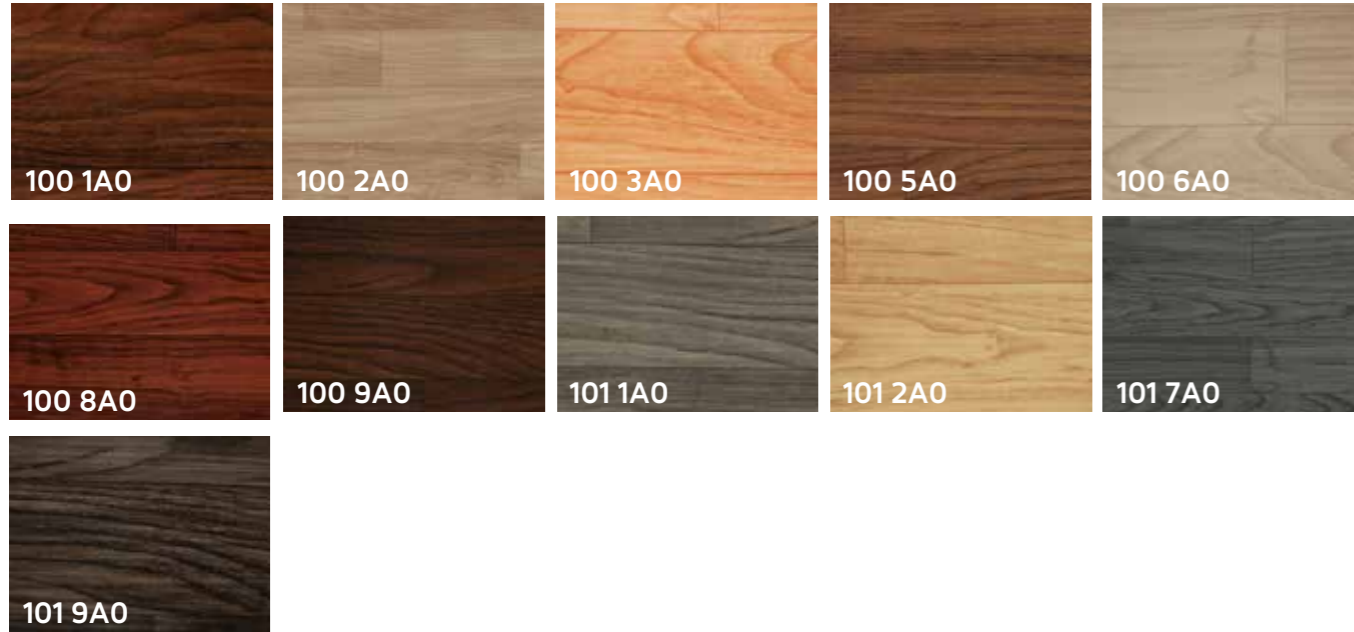

## PORTO ( 620 )

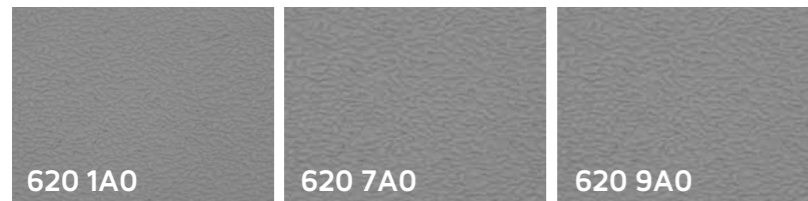

## HEELPAD ( 700 )

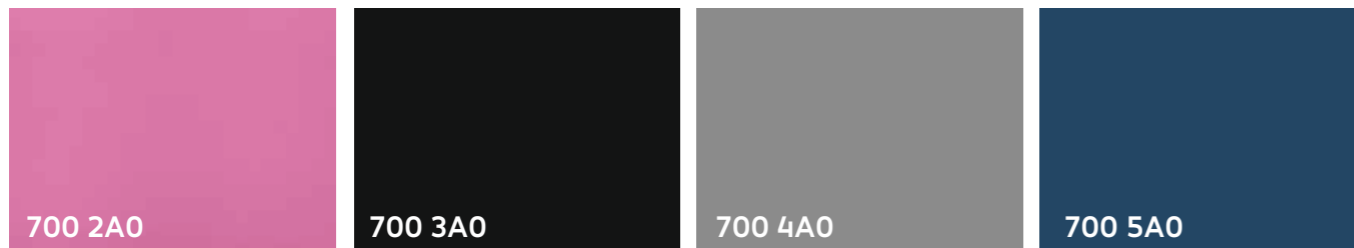

\*\* Real products may differ from above images. Please kindly note to ask for real products samples before confirming your order.

\*\* Gerçek ürünler yukarıdaki resimlerden farklı olabilir. Lütfen siparişinizi vermeden önce gerçek ürün numunelerini istemeyi unutmayın.

\*\* Реальные продукты могут отличаться от изображений выше. Пожалуйста, обратите внимание, чтобы запросить образцы реальной продукции перед подтверждением вашего заказа.

Multi-Layered Vinyl Flooring

Çok Katmanlı Vinil Döşeme

Многослойный виниловый пол

## TAPIS ( 470 )

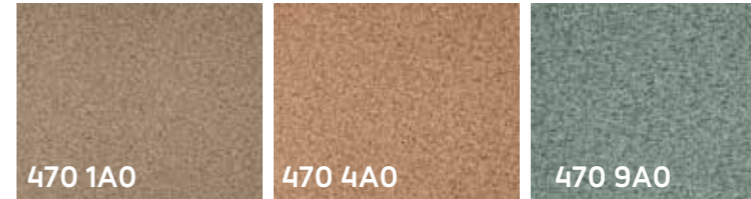

## MODERNO ( 111 )

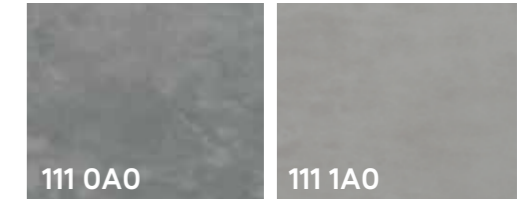

## BETONIST ( 210 )



## VEGA ( 891 )

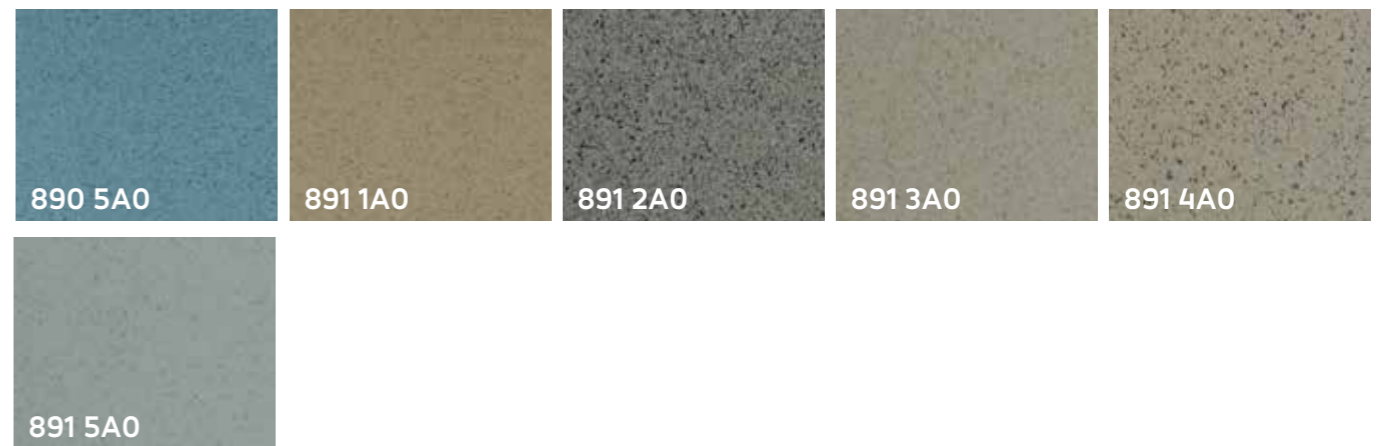

## STONETTE ( A00 )



\*\* Real products may differ from above images. Please kindly note to ask for real products samples before confirming your order.

\*\* Gerçek ürünler yukarıdaki resimlerden farklı olabilir. Lütfen siparişinizi vermeden önce gerçek ürün numunelerini istemeyi unutmayın.

\*\* Реальные продукты могут отличаться от изображений выше. Пожалуйста, обратите внимание, чтобы запросить образцы реальной продукции перед подтверждением вашего заказа.

# HomeFlex LITE

Multi-Layered Vinyl Flooring

Çok Katmanlı Vinil Döşeme

Многослойный виниловый пол

## PLAYER ( A30 )



A30 1A0

## CHECKER ( A40 )



A40 1A0

## HAMMAM (640)

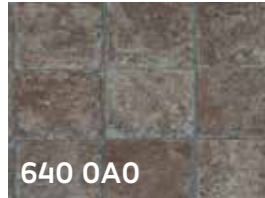

640 0A0



640 1A0



640 2A0



640 3A0

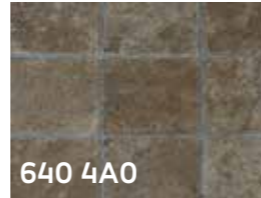

640 4A0

## MESHE

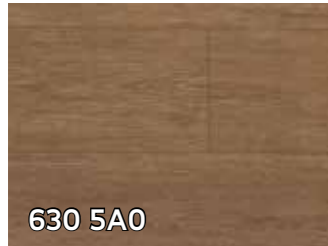

630 5A0



630 6A0



630 7A0



630 8A0



630 9A0

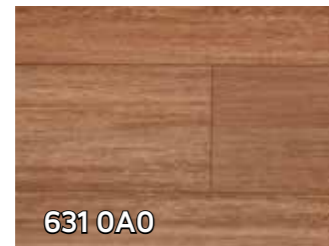

631 0A0

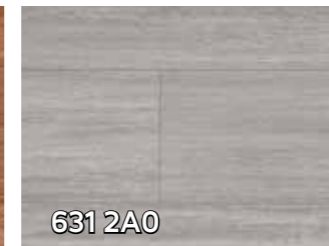

631 2A0



631 3A0



632 3A0

Heterogeneous Commercial  
Floor CoveringsHeterojen Ticari  
Zemin KaplamalarıКонтрактные гетерогенные  
коммерческие напольные  
покрытия

# YERKOP



\*\* Real products may differ from above images. Please kindly note to ask for real products samples before confirming your order.

\*\* Gerçek ürünler yukarıdaki resimlerden farklı olabilir. Lütfen siparişinizi vermeden önce gerçek ürün numunelerini istemeyi unutmayın.

\*\* Реальные продукты могут отличаться от изображений выше. Пожалуйста, обратите внимание, чтобы запросить образцы реальной продукции перед подтверждением вашего заказа.

# net

FLOOR COVERINGS

www.netfloor.com.tr

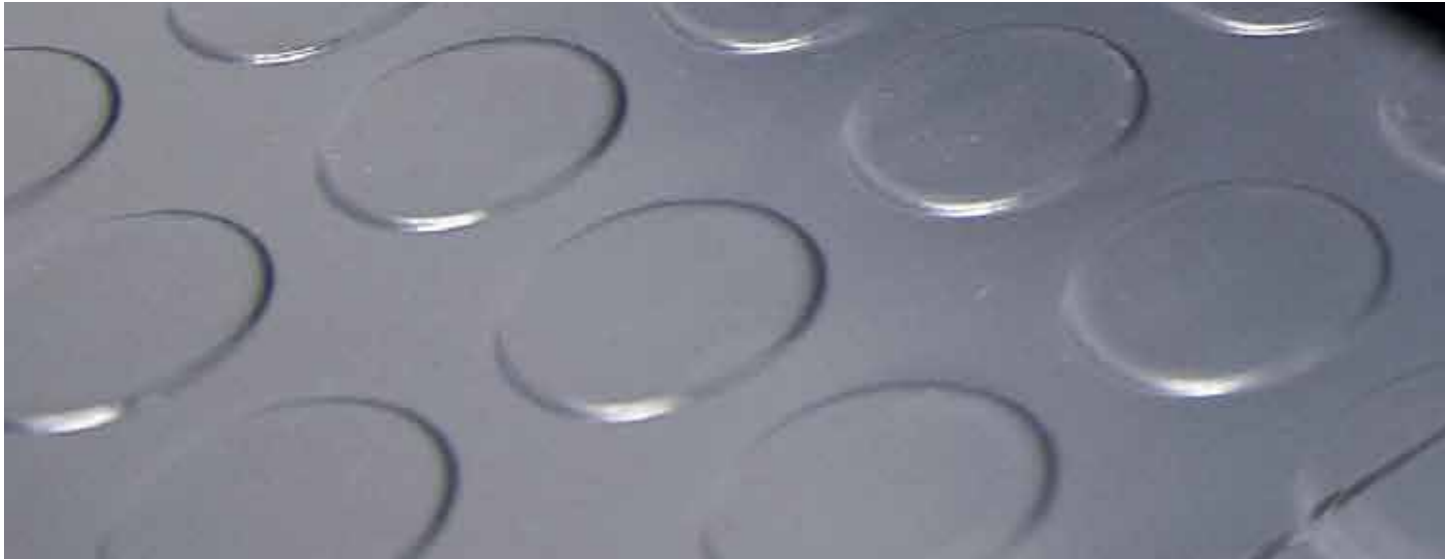

## Heterogeneous Commercial Floor Coverings



## Heterojen Ticari Zemin Kaplamaları



## Контрактные гетерогенные коммерческие напольные покрытия



- Is a floor covering designed for commercial areas.
- Does not absorb water.
- Remarkable with its 3 dimensioned surface.
- It is more durable than foam based alternatives with its dense compact structure.
- Has maximum resistance against residual indentations sourcing from heavy loads.
- Is completely environment-friendly and 100% recyclable.
- Has a wide visual range with its different colors and embosses.
- Our standard Yerkap colors are 150, 300, 325, 400, 700, 900.
- All Yerkap products can be produced with preferred colour-design patterns chosen from our booklets and having a 1.00-4.00 mm total thickness.
- All Yerkap products can be produced with selected colour-design patterns chosen from our booklets and having a 0.10 – 1.20 mm wear layer thickness to be determined according to preferred total thickness.
- Can be manufactured as anti-bacterial if desired.
- Can be manufactured in RAL codes if preferred. Please ask for the minimum order quantity for special colors presented in color palette.
- Can be manufactured in BflS1 fire class if desired.
- Includes recycled PVC. Can be manufactured with virgin PVC if desired. Please ask for the minimum order quantity for special chemical structure.
- Heelpad, Zincir, Agac, Porto embosses are convenient for hot-welding
- Porto emboss has R10 slip resistance.

- Ticari mekanlar için tasarlanmış bir zemin kaplama malzemesidir.
- Su emmez.
- 3 boyutlu yüzeyi ile dikkat çekicidir.
- Sıkıştırılmış kompakt yapısı sayesinde köpük tabanlı muadillerinden daha mukavimdir.
- Ağır statik yüklerin sebep olabileceği kalıcı ezilmelere maksimum düzeyde dayanır.
- Tamamen çevre dostudur ve %100 geri dönüşümlüdür.
- Farklı renk ve desen çeşitleriyle geniş bir görsellik yelpazesine sahiptir.
- Standart Yerkap renklerimiz 150, 300, 325, 400, 700, 900 dür.
- Tüm Yerkap ürünleri, kataloglarımızdan seçilen renk ve desen görsellğinde ve 1.00-4.00 mm toplam kalınlıkta üretilebilir.
- Tüm Yerkap ürünleri, kataloglarımızdan seçilen renk ve desen görsellğinde ve belirlenen toplam kalınlığa göre seçilecek 0.10mm-1.20mm aşınma tabakası kalınlığında üretilebilir.
- İstendiğinde anti-bakteriyel olarak da üretilebilir.
- İstenildiğinde RAL kodları ile de üretimi yapılabilir.
- Renk Kartelasından seçtiğiniz özel renklerimiz için minimum sipariş miktarlarını sorunuz.
- İstendiğinde BflS1 yanma sınıfında üretilebilir.
- Geri dönüşmüş PVC ihtiva eder. İstenildiğinde orijinal PVC ile imal edilebilir. Özel kimyasal yapı için minimum sipariş miktarını sorunuz.
- Düz,zincir, porto ve ağaç desenler sıcak kaynak uygulamasına uygundur.

- Материал для напольных покрытий, предназначенный для торговых помещений.
- Не впитывает воду.
- Привлекательный вид благодаря поверхности с трехмерным эффектом.
- Обладает более высокой износостойкостью по сравнению с аналогами из пены благодаря уплотненной компактной структуре.
- Обладает максимальной стойкостью к продавливанию под воздействием больших статических нагрузок.
- Полностью экологически чистый материал и на 100 % пригоден для рециклинга (переработки).
- Предлагается широкая цветовая палитра и широкий выбор типов рисунка. Стандартные цветовые исполнения напольного покрытия
- «Yerkap»: 150, 300, 325, 400, 700 и 900.
- Вся продукция «Yerkap» может изготавливаться в представленной в наших каталогах цветовой палитре и с типом рисунка на выбор и общей толщиной от 1.00 мм до 4.00 мм.
- Вся продукция «Yerkap» может изготавливаться в представленной в наших каталогах цветовой палитре и с типом рисунка на выбор и со слоем для придания износостойкости толщиной от 0.10 мм до 1.20 мм в зависимости от выбранной общей толщины.
- По желанию покупателя может быть изготовлено в антибактериальном исполнении.
- По желанию покупателя может быть изготовлено согласно кодам RAL. Пожалуйста обратитесь за информацией о минимальном объеме заказа в случае необходимости изготовления в особом цветовом исполнении, выбранном из цветового каталога.
- По желанию покупателя может быть изготовлен согласно требованиям к группе горючести BflS1.
- Содержит переработанный ПВХ. По желанию покупателя может быть изготовлено с использованием непереработанного ПВХ. Пожалуйста обратитесь за информацией о минимальном объеме заказа в случае необходимости в специальной химической формуле продукта.
- Типы рисунка и узоров «düz» (сплошной), «zincir» (цепочка), «porto» (porto) и «ağac» (дерево) подходят для «горячего монтажа».
- Напольное покрытие с типом рисунка «porto» (porto) относится к группе R10 по устойчивости к скольжению.

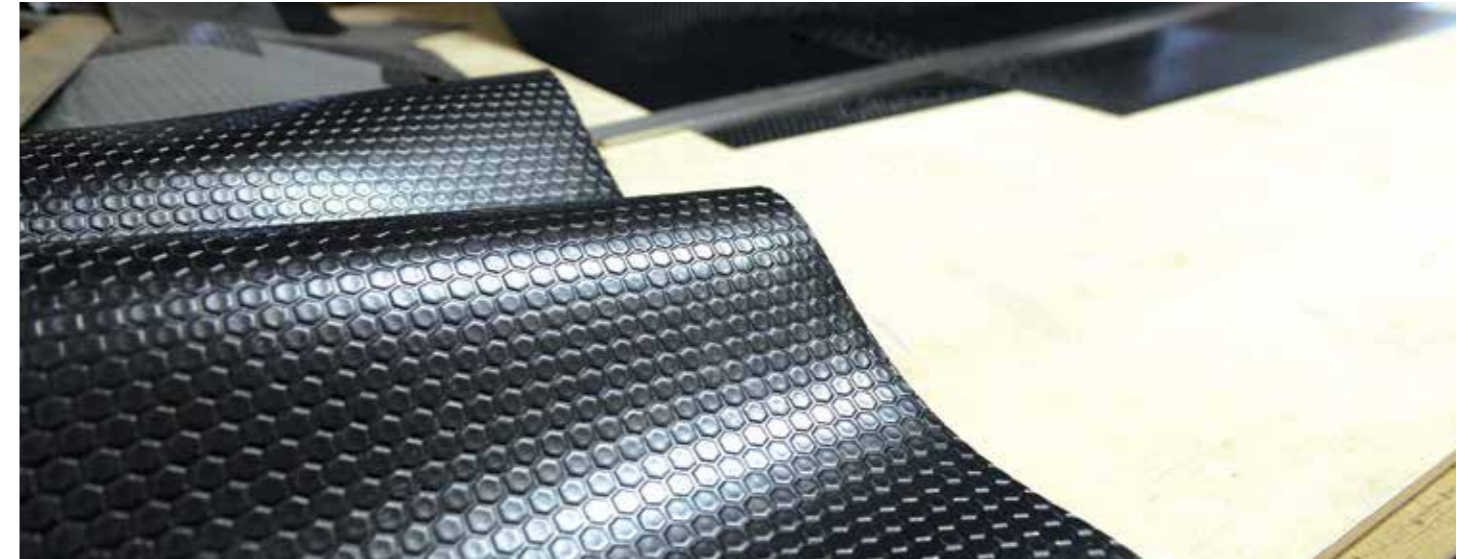

## Layer Diagrams



## Katman Şemaları



## Диаграммы слоев



### Wear Layer

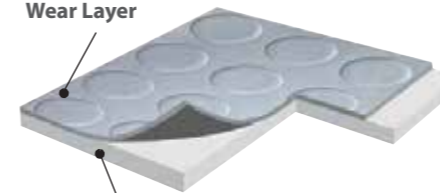

### Compact Back Layer

"Some products may use a different product architecture than the illustration above."



### Aşınma Tabakası



### Kompakt Alt Taban

"Kimi ürünlerde, yukarıdaki gösterimden farklı ürün mimarisini kullanılabılır."



### Полиуретановая защита

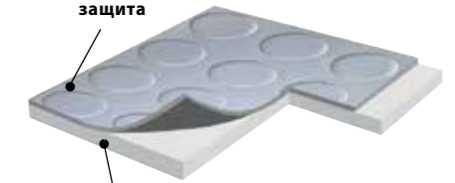

### Компактная задняя база

"Некоторые продукты могут использовать архитектуру продукта, отличную от той, что показана на рисунке выше."



## TECHNICAL DATA SHEET

## PRODUCT IDENTIFICATION : YERKAP EMOSS

## TECHNICAL PROPERTIES

SPECIFICATION	STANDARD	PRODUCT									
		GROUP C									
Usage Class	EN ISO 10874	N/A	Domestic: 21	Domestic: 22-22+	Domestic: 21	Domestic: 23 Commercial: 31	Domestic: 23 Commercial: 31	Commercial: 33 Industrial: 42	Commercial: 33 Industrial: 42	Commercial: 34 Industrial: 43	
Total Thickness	EN ISO 24346	1 mm (min:-0.10 mm max: 0.13 mm)	1.20 mm (min:-0.10 mm max: 0.13 mm)	1.50 mm (min:-0.10 mm max: 0.13 mm)	2 mm (min:-0.10 mm max: 0.13 mm)	2 mm (min:-0.10 mm max: 0.13 mm)	2.50 mm (min:-0.10 mm max: 0.13 mm)	3 mm (min:-0.10 mm max: 0.13 mm)	3.50 mm (min:-0.10 mm max: 0.13 mm)	4 mm (min:-0.10 mm max: 0.13 mm)	
Wear Layer Thickness	EN ISO 24340	0.10 mm (max:+%13 min: -%10)	0.15 mm (max:+%13 min: -%10)	0.20 mm (max:+%13 min: -%10)	0.15 mm (max:+%13 min: -%10)	0.30 mm (max:+%13 min: -%10)	0.30 mm (max:+%13 min: -%10)	0.55 mm (max:+%13 min: -%10)	0.55 mm (max:+%13 min: -%10)	0.70 mm (max:+%13 min: -%10)	
Total Weight	EN ISO 23997	1500 g/m <sup>2</sup> (max:+%13 min: -%10)	1805 g/m <sup>2</sup> (max:+%13 min: -%10)	2260 g/m <sup>2</sup> (max:+%13 min: -%10)	3040 g/m <sup>2</sup> (max:+%13 min: -%10)	3025 g/m <sup>2</sup> (max:+%13 min: -%10)	4270 g/m <sup>2</sup> (max:+%13 min: -%10)	4740 g/m <sup>2</sup> (max:+%13 min: -%10)	5270 g/m <sup>2</sup> (max:+%13 min: -%10)	6060 g/m <sup>2</sup> (max:+%13 min: -%10)	
Roll Width	EN ISO 24341	2 m	2 m	2 m	2 m	2 m	2 m	2 m	2 m	2 m	
Roll Length	EN ISO 24341	20 m	20 m	20 m	20 m	20 m	20 m	20 m	20 m	20 m	

## PERFORMANCE

Wear Layer Group	EN 660-2	GROUP T	GROUP T	GROUP T	GROUP T	GROUP T	GROUP T	GROUP T	GROUP T	GROUP T
Binder Content	ISO 10582	TYPE 1	TYPE 1	TYPE 1	TYPE 1	TYPE 1	TYPE 1	TYPE 1	TYPE 1	TYPE 1
Effect of a Castor Chair	ISO 4918	N/A	N/A	N/A	N/A	N/A	N/A	No deformation after 25.000 cycles	No deformation after 25.000 cycles	No deformation after 25.000 cycles
Test for Color Fastness	EN ISO 105-B02	≥6	≥6	≥6	≥6	≥6	≥6	≥6	≥6	≥6
Dimensional Stability	EN ISO 23999	≤%0.4	≤%0.4	≤%0.4	≤%0.4	≤%0.4	≤%0.4	≤%0.4	≤%0.4	≤%0.4
Curling	EN ISO 23999	Max:8 mm	Max:8 mm	Max:8 mm	Max:8 mm	Max:8 mm	Max:8 mm	Max:8 mm	Max:8 mm	Max:8 mm
Residual Indentation	EN ISO 24343-1	≤0.1 mm	≤0.1 mm	≤0.1 mm	≤0.1 mm	≤0.1 mm	≤0.1 mm	≤0.1 mm	≤0.1 mm	≤0.1 mm
Determination of Staining and Resistance to Chemicals	EN ISO 26987	Ok	Ok	Ok	Ok	Ok	Ok	Ok	Ok	Ok
Seam Strength	EN 684	N/A	N/A	N/A	N/A	N/A	N/A	N/A	N/A	N/A
Flexibility	EN ISO 24344	No Crack	No Crack	No Crack	No Crack	No Crack	No Crack	No Crack	No Crack	No Crack

\*\*\* GROUP C : 400-MEGA,105-PARALI, 310 ORTAPARA, 155-TRANSİT, 55-LİNEAR, 205-PETEK, 900-PORTER

In case, you otherwise specify, standard YerKap products are produced with recycled PVC ingredients which the chemical history is not certified and is accepted as unknown. The chemical structure, ingredients, and chemical behaviors, including fire behavior, cannot be warranted and are not declarable

because of this recycled PVC content. However, is an optional variant and is produced with only virgin raw material ingredients, and thus

its chemical structure and chemical behaviors, including fire behavior, is totally declarable. Please kindly contact your supplier for further information.

\* Sipariş geçmeden önce, lütfen güncel TDS verilerini talep edin.

\* Before placing an order, please request up-to-date TDS data.

## TECHNICAL DATA SHEET

## PRODUCT IDENTIFICATION : YERKAP HEELPAD

## TECHNICAL PROPERTIES

SPECIFICATION	STANDARD	PRODUCT										
		GROUP A										GROUP B
Usage Class	EN ISO 10874	N/A	Domestic: 21	Domestic: 22-22+	Domestic: 21	Domestic: 23 Commercial: 31	Domestic: 23 Commercial: 31	Commercial: 33 Industrial: 42	Commercial: 33 Industrial: 42	Commercial: 34 Industrial: 43	Domestic: 23 Commercial: 31	
Total Thickness	EN ISO 24346	1mm (min:-0.10mm max: 0.13mm)	1.2mm (min:-0.10mm max: 0.13mm)	1.5mm (min:-0.10mm max: 0.13mm)	2mm (min:-0.10mm max: 0.13mm)	2mm (min:-0.10mm max: 0.13mm)	2.5mm (min:-0.10mm max: 0.13mm)	3mm (min:-0.10mm max: 0.13mm)	3.5mm (min:-0.10mm max: 0.13mm)	4mm (min:-0.10mm max: 0.13mm)	2mm (min:-0.10mm max: 0.13mm)	
Wear Layer Thickness	EN ISO 24340	0.10mm (max:+%13 min: -%10)	0.15mm (max:+%13 min: -%10)	0.20mm (max:+%13 min: -%10)	0.15mm (max:+%13 min: -%10)	0.30mm (max:+%13 min: -%10)	0.30mm (max:+%13 min: -%10)	0.55mm (max:+%13 min: -%10)	0.55mm (max:+%13 min: -%10)	0.70mm (max:+%13 min: -%10)	0.30mm (max:+%13 min: -%10)	
Total Weight	EN ISO 23997	1540 g/m <sup>2</sup> (max:+%13 min: -%10)	1850 g/m <sup>2</sup> (max:+%13 min: -%10)	2520 g/m <sup>2</sup> (max:+%13 min: -%10)	3135 g/m <sup>2</sup> (max:+%13 min: -%10)	3360 g/m <sup>2</sup> (max:+%13 min: -%10)	3920 g/m <sup>2</sup> (max:+%13 min: -%10)	4670 g/m <sup>2</sup> (max:+%13 min: -%10)	5460 g/m <sup>2</sup> (max:+%13 min: -%10)	6250 g/m <sup>2</sup> (max:+%13 min: -%10)	3360 g/m <sup>2</sup> (max:+%13 min: -%10)	
Roll Width	EN ISO 24341	200cm	200cm	200cm	200cm	200cm	200cm	200cm	200cm	200cm	200cm	
Roll Length	EN ISO 24341	20m	20m	20m	20m	20m	20m	20m	20m	20m	20m	

## PERFORMANCE

Wear Layer Group	EN 660-2	GROUP T	GROUP T	GROUP T	GROUP T	GROUP T	GROUP T	GROUP T	GROUP T	GROUP T	GROUP T
Binder Content	ISO 10582	TYPE 1	TYPE 1	TYPE 1	TYPE 1	TYPE 1	TYPE 1	TYPE 1	TYPE 1	TYPE 1	TYPE 1
Effect of a Castor Chair	ISO 4918	N/A	N/A	N/A	N/A	N/A	N/A	No deformation after 25.000 cycles	No deformation after 25.000 cycles	No deformation after 25.000 cycles	N/A
Test for Color Fastness	EN ISO 105-B02	≥6	≥6	≥6	≥6	≥6	≥6	≥6	≥6	≥6	≥6
Dimensional Stability	EN ISO 23999	≤%0.4	≤%0.4	≤%0.4	≤%0.4	≤%0.4	≤%0.4	≤%0.4	≤%0.4	≤%0.4	≤%0.4
Curling	EN ISO 23999	Max:8mm	Max:8mm	Max:8mm	Max:8mm	Max:8mm	Max:8mm	Max:8mm	Max:8mm	Max:8mm	Max:8mm
Residual Indentation	EN ISO 24343-1	≤0.1mm	≤0.1mm	≤0.1mm	≤0.1mm	≤0.1mm	≤0.1mm	≤0.1mm	≤0.1mm	≤0.1mm	≤0.1mm
Determination of Staining and Resistance to Chemicals	EN ISO 26987	Ok	Ok	Ok	Ok	Ok	Ok	Ok	Ok	Ok	Ok
Seam Strength	EN 684	N/A	N/A	N/A	N/A	N/A	N/A	N/A	N/A	N/A	N/A
Flexibility	EN ISO 24344	No Crack	No Crack	No Crack	No Crack	No Crack	No Crack	No Crack	No Crack	No Crack	No Crack

\*\*\* GROUP A : 700-HEELPAD, 600 ZİNCİR, 590 AĞAÇ \*\*\*GROUP B : 620-PORTO

In case, you otherwise specify, standard YerKap products are produced with recycled PVC ingredients which the chemical history is not certified and is accepted as unknown. The chemical structure, ingredients, and chemical behaviors, including fire behavior, cannot be warranted and are not declarable

because of this recycled PVC content. However, is an optional variant and is produced with only virgin raw material ingredients, and thus

its chemical structure and chemical behaviors, including fire behavior, is totally declarable. Please kindly contact your supplier for further information.

\* Sipariş geçmeden önce, lütfen güncel TDS verilerini talep edin.

\* Before placing an order, please request up-to-date TDS data.

Recycled PVC Content	✓	✗
CE	✗	✓
Wear Group	Group T	Group T
Binder Content	Type 1	Type 1
Abrasion Resistance	✓	✓
100% Recyclable	✓	✓
Flexibility	✓	✓
Easy to Clean	✓	✓
Chemical Structure Declaration	✗	✓
Burning Behavior Declaration	✗	✓
Price	\$	\$ \$

## HEELPAD ( 700 )

 700 400-00-HP-00	 700 150-00-HP-00	 700 325-00-HP-00	 700 600-00-HP-00
 700 700-00-DZ-00	 700 170-00-HP-00	 700 350-00-HP-00	 700 220-00-HP-00
 700 725-00-HP-00	 700 500-00-HP-00	 700 550-00-HP-00	 700 300-00-HP-00
 700 625-00-HP-00	 700 800-00-HP-00		

## LINEAR ( 550 )

 550 600-00-LR-00	 550 900-00-LR-00	 550 300-00-LR-00	 550 220-00-LR-00
----------------------	----------------------	----------------------	----------------------

## CRAFT ( 450 )

 450 100	 450 300	 450 400	 450 700	 450 900
-------------	-------------	-------------	-------------	-------------

\*\* Real products may differ from above images. Please kindly note to ask for real products samples before confirming your order.

\*\* Gerçek ürünler yukarıdaki resimlerden farklı olabilir. Lütfen siparişinizi vermeden önce gerçek ürün numunelerini istemeyi unutmayın.

\*\* Реальные продукты могут отличаться от изображений выше. Пожалуйста, обратите внимание, чтобы запросить образцы реальной продукции перед подтверждением вашего заказа.

Heterogeneous Commercial  
Floor Coverings

Heterojen Ticari  
Zemin Kaplamaları

Контрактные гетерогенные  
коммерческие напольные покрытия

### MEGA ( 400 )



### PARA ( 105 )



\*\* Real products may differ from above images. Please kindly note to ask for real products samples before confirming your order.

\*\* Gerçek ürünler yukarıdaki resimlerden farklı olabilir. Lütfen siparişinizi vermeden önce gerçek ürün numunelerini istemeyi unutmayın.

\*\* Реальные продукты могут отличаться от изображений выше. Пожалуйста, обратите внимание, чтобы запросить образцы реальной продукции перед подтверждением вашего заказа.

Heterogeneous Commercial  
Floor Coverings

Heterojen Ticari  
Zemin Kaplamaları

Контрактные гетерогенные  
коммерческие напольные покрытия

### ORTA PARALI ( 310 )

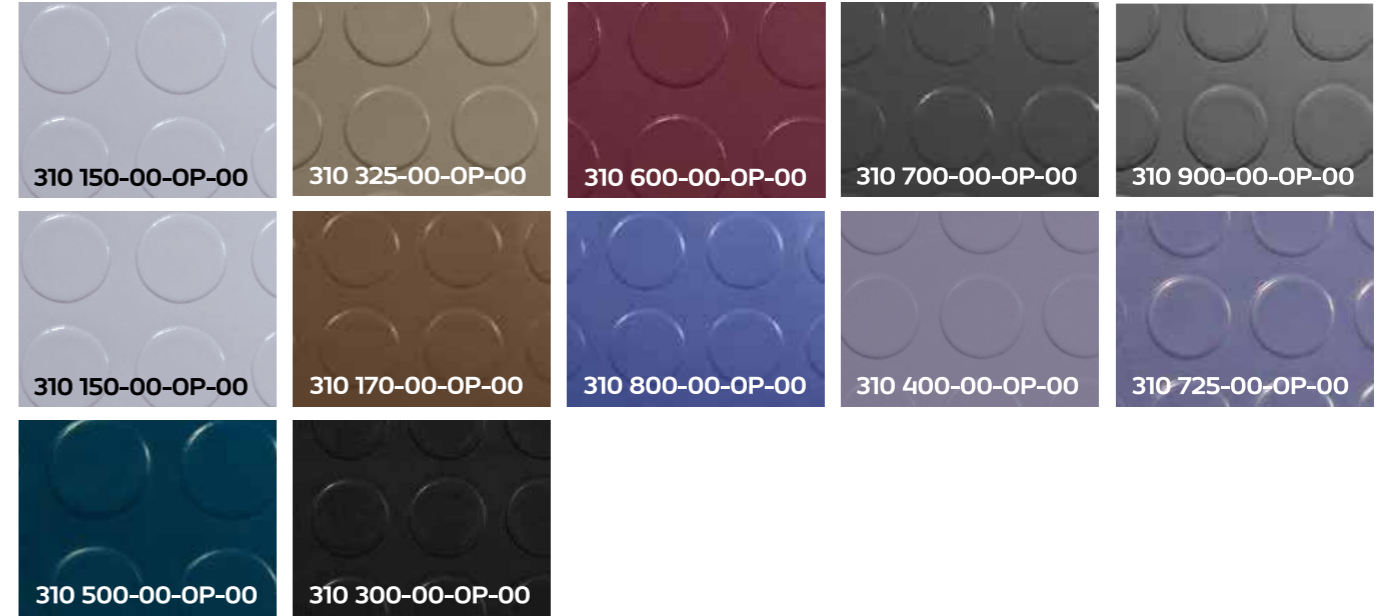

### TRANSİT ( 155 )



\*\* Real products may differ from above images. Please kindly note to ask for real products samples before confirming your order.

\*\* Gerçek ürünler yukarıdaki resimlerden farklı olabilir. Lütfen siparişinizi vermeden önce gerçek ürün numunelerini istemeyi unutmayın.

\*\* Реальные продукты могут отличаться от изображений выше. Пожалуйста, обратите внимание, чтобы запросить образцы реальной продукции перед подтверждением вашего заказа.

Heterogeneous Commercial  
Floor Coverings

Heterojen Ticari  
Zemin Kaplamaları

Контрактные гетерогенные  
коммерческие напольные покрытия

### PETEK ( 205 )

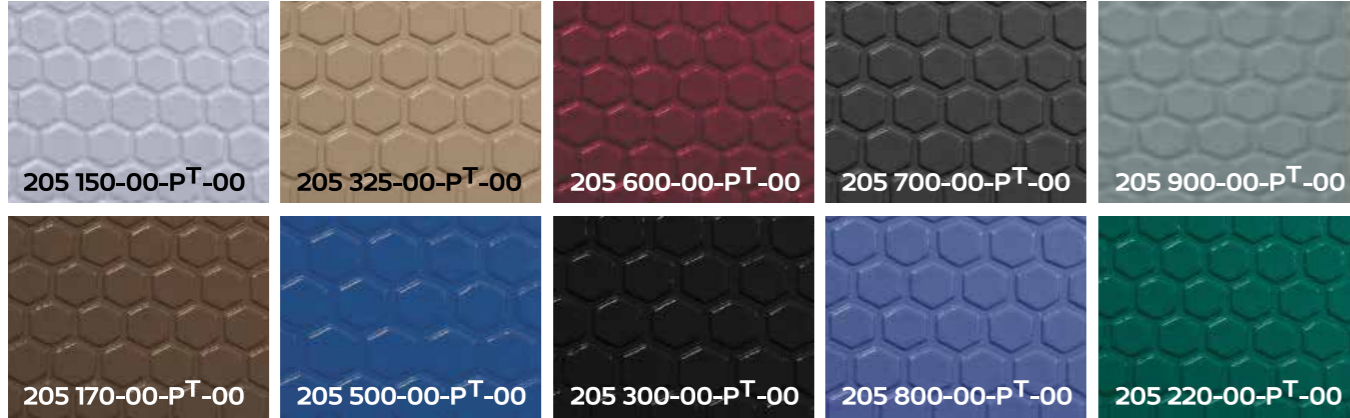

### DAMA ( 800 )



### PORTER ( 900 )



### MIRROR

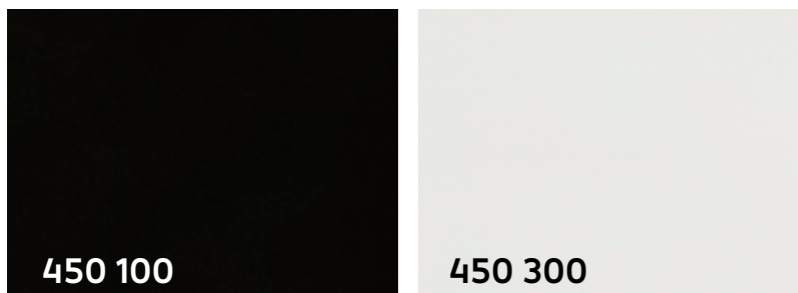

\*\* Real products may differ from above images. Please kindly note to ask for real products samples before confirming your order.

\*\* Gerçek ürünler yukarıdaki resimlerden farklı olabilir. Lütfen siparişinizi vermeden önce gerçek ürün numunelerini istemeyi unutmayın.

\*\* Реальные продукты могут отличаться от изображений выше. Пожалуйста, обратите внимание, чтобы запросить образцы реальной продукции перед подтверждением вашего заказа.

Heterogeneous Commercial  
Floor Coverings

Heterojen Ticari  
Zemin Kaplamaları

Контрактные гетерогенные  
коммерческие напольные покрытия

### AĞAÇ ( 590 )

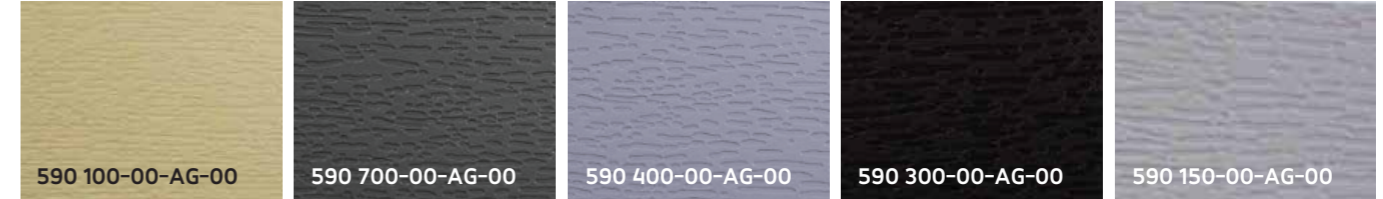

### ZİNCİR ( 600 )



### PORTO ( 620 )

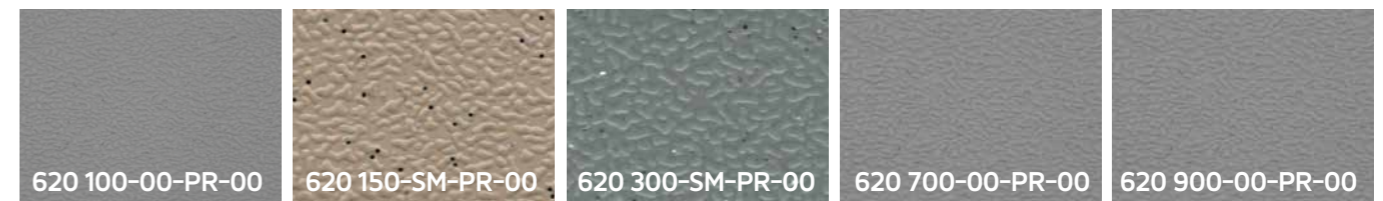

\*\* Real products may differ from above images. Please kindly note to ask for real products samples before confirming your order.

\*\* Gerçek ürünler yukarıdaki resimlerden farklı olabilir. Lütfen siparişinizi vermeden önce gerçek ürün numunelerini istemeyi unutmayın.

\*\* Реальные продукты могут отличаться от изображений выше. Пожалуйста, обратите внимание, чтобы запросить образцы реальной продукции перед подтверждением вашего заказа.



EcoFlex

Multi-layered Compact  
Vinyl Flooring

Çok Katmanlı Kompakt  
Vinil Zemin Kaplamaları

Многослойный компактный  
ВИНИЛОВЫЙ ПОЛ

EcoFlex



**For Moderate  
Commercial Areas**

Orta Düzey Ticari  
Alanlar İçin

Для средних  
коммерческих площадей

**net**  
FLOOR COVERINGS

[www.netfloor.com.tr](http://www.netfloor.com.tr)



### Multi-layered Compact Vinyl Flooring



### Çok Katmanlı Kompakt Vinil Zemin Kaplamaları



### Многослойный компактный ВИНИЛОВЫЙ ПОЛ



- Has polyurathane based PURGUARD protection layer on its top surface.
- Can easily be cleaned by the help of its PURGUARD layer.
- No glass change under short-term heat contact by the help of its PURGUARD layer.
- Ecoflex is a T-class floor covering.
- Is entirely environment friendly and %100 recyclable.
- Is more resistant than is foam-backed equivalents due to its compressed compact structure.
- Includes embedded glass-fiber tissue for comfortable applications and long-term use.
- Has a wide visual spectrum with various colour and design preferences.

- En üst yüzeyinde poliürethan esaslı PURGUARD koruması içerir.
- PURGUARD sayesinde kolayca temizlenir.
- PURGUARD sayesinde kısa süreli ısı teması altında da parlamaz.
- Ecoflex, T sınıfı bir zemin kaplamasıdır.
- Tamamen çevre dostudur ve %100 geri dönüşümlüdür.
- Sıkıştırılmış kompakt yapısı sayesinde köpük tabanlı muadillerinden daha mukavimdir.
- En rahat uygulamalar ve uzun ömürlü kullanım için cam elyafı içerir.
- Farklı renk ve desen çeşitleriyle geniş bir görsellik yelpazesine sahiptir.

- В состав самого верхнего слоя покрытия входит защитный компонент PURGUARD на основе полиуретана.
- Благодаря PURGUARD покрытие легко очищается.
- Защитный слой PURGUARD предотвращает появление отражающего блеска на поверхности при кратковременном её контакте с высокими температурами.
- EcoFlex – это напольное покрытие T класса.
- Экологически безопасно и на 100% подлежит вторичной переработке.
- Благодаря спрессованной компактной структуре, материал более прочен по сравнению с аналогичными покрытиями на вспененной основе.
- Благодаря спрессованной компактной структуре, материал более прочен по сравнению с аналогичными покрытиями на вспененной основе.
- Покрытие представлено в широком ассортименте, включающем различные цветовые и фактурные варианты.



TS EN ISO 10582



### Layer Diagrams



### Katman Şemaları



### Диаграммы слоев

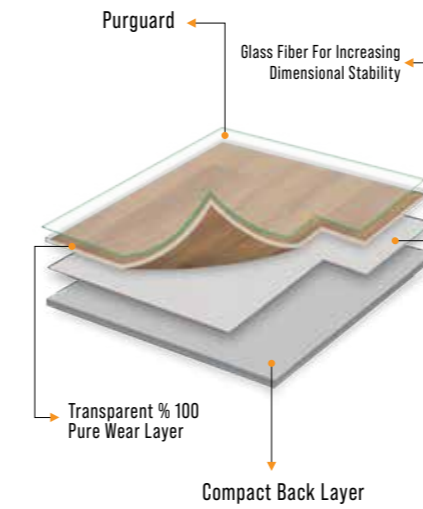

"Some products may use a different product architecture than the illustration above."

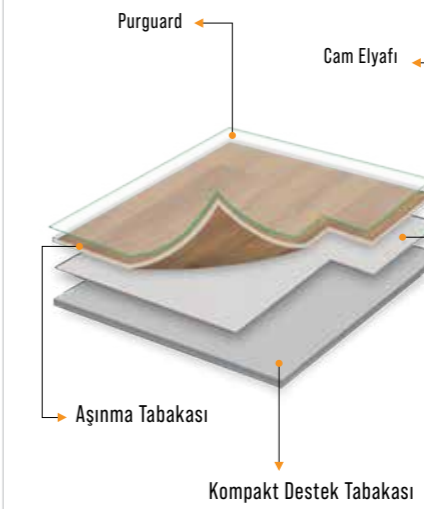

"Kimi ürünlerde, yukarıdaki gösterimden farklı ürün mimarisi kullanılabilir."

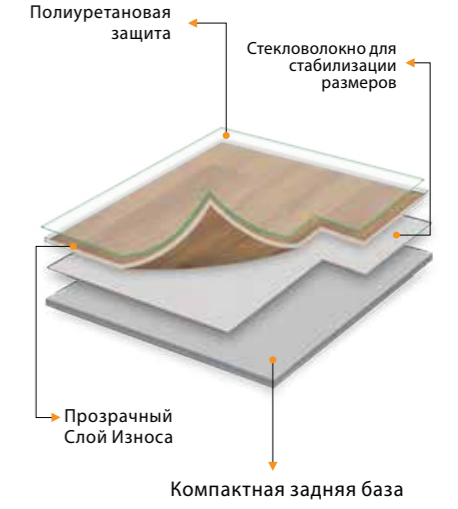

"Некоторые продукты могут использовать архитектуру продукта, отличную от той, что показана на рисунке выше."



TS EN ISO 10582



GLASS FIBER TISSUE : OK  
PURGUARD : OK

## TECHNICAL DATA SHEET

## PRODUCT IDENTIFICATION : ECOFLEX

## TECHNICAL PROPERTIES

SPECIFICATION	STANDARD	PRODUCT						
Usage Class	EN ISO 10874	Domestic:21	Domestic:23	N/A	Domestic:22-22+	Domestic:23 Commercial:31	Commercial:32 Industrial: 41	Commercial:32 Industrial: 41
Total Thickness	EN ISO 24346	1.50 mm (min:-0.10 mm max: 0.13 mm)	1.80 mm (min:-0.10 mm max: 0.13 mm)	2 mm (min:-0.10 mm max: 0.13 mm)	2 mm (min:-0.10 mm max: 0.13 mm)	2 mm (min:-0.10 mm max: 0.13 mm)	2 mm (min:-0.10 mm max: 0.13 mm)	2 mm (min:-0.10 mm max: 0.13 mm)
Wear Layer Thickness	EN ISO 24340	0.15 mm (max:+%13 min: -%10)	0.30 mm (max:+%13 min: -%10)	0.10 mm (max:+%13 min: -%10)	0.20 mm (max:+%13 min: -%10)	0.30 mm (max:+%13 min: -%10)	0.40 mm (max:+%13 min: -%10)	0.55 mm (max:+%13 min: -%10)
Total Weight	EN ISO 23997	2350 g/m <sup>2</sup> (max:+%13 min: -%10)	2760g/m <sup>2</sup> (max:+%13 min: -%10)	3250g/m <sup>2</sup> (max:+%13 min: -%10)	3200g/m <sup>2</sup> (max:+%13 min: -%10)	3160g/m <sup>2</sup> (max:+%13 min: -%10)	3115g/m <sup>2</sup> (max:+%13 min: -%10)	2980g/m <sup>2</sup> (max:+%13 min: -%10)
Roll Width	EN ISO 24341	2 m	2 m	2 m	2 m	2 m	2 m	2 m
Roll Length	EN ISO 24341	20 m	20 m	20 m	20 m	20 m	20 m	20 m

## PERFORMANCE

Wear Layer Group	EN 660-2	GROUP T	GROUP T	GROUP T	GROUP T	GROUP T	GROUP T	GROUP T
Binder Content	ISO 10582	TYPE 1	TYPE 1	TYPE 1	TYPE 1	TYPE 1	TYPE 1	TYPE 1
Effect of a Castor Chair	ISO 4918	N/A	N/A	N/A	N/A	No deformation after 25.000 cycles	No deformation after 25.000 cycles	No deformation after 25.000 cycles
Test for Color Fastness	EN ISO 105-B02	≥6	≥6	≥6	≥6	≥6	≥6	≥6
Dimensional Stability	EN ISO 23999	≤%0.4	≤%0.4	≤%0.4	≤%0.4	≤%0.4	≤%0.4	≤%0.4
Curling	EN ISO 23999	Max:8 mm	Max:8 mm	Max:8 mm	Max:8 mm	Max:8 mm	Max:8 mm	Max:8 mm
Residual Indentation	EN ISO 24343-1	≤0.1 mm	≤0.1 mm	≤0.1 mm	≤0.1 mm	≤0.1 mm	≤0.1 mm	≤0.1 mm
Determination of Staining and Resistance to Chemicals	EN ISO 26987	Ok	Ok	Ok	Ok	Ok	Ok	Ok
Seam Strength	EN 684	N/A	N/A	N/A	N/A	≥240 N/50 mm	≥240 N/50 mm	≥240 N/50 mm
Flexibility	EN ISO 24344	No Crack	No Crack	No Crack	No Crack	No Crack	No Crack	No Crack

Standard products are produced with recycled PVC. Chemical structure, ingredients and chemical behaviours can not be warranted. It is optional to use only virgin raw material upon your request in case you like to have a declaration for chemical ingredients and chemical behaviors. Please kindly contact your supplier for further information.

\* Sipariş geçmeden önce, lütfen güncel TDS verilerini talep edin.

\* Before placing an order, please request up-to-date TDS data.

## SANTE ( 492 / 493 / 494 / 495 )



## JOKER ( 200 / 201 / 202 )

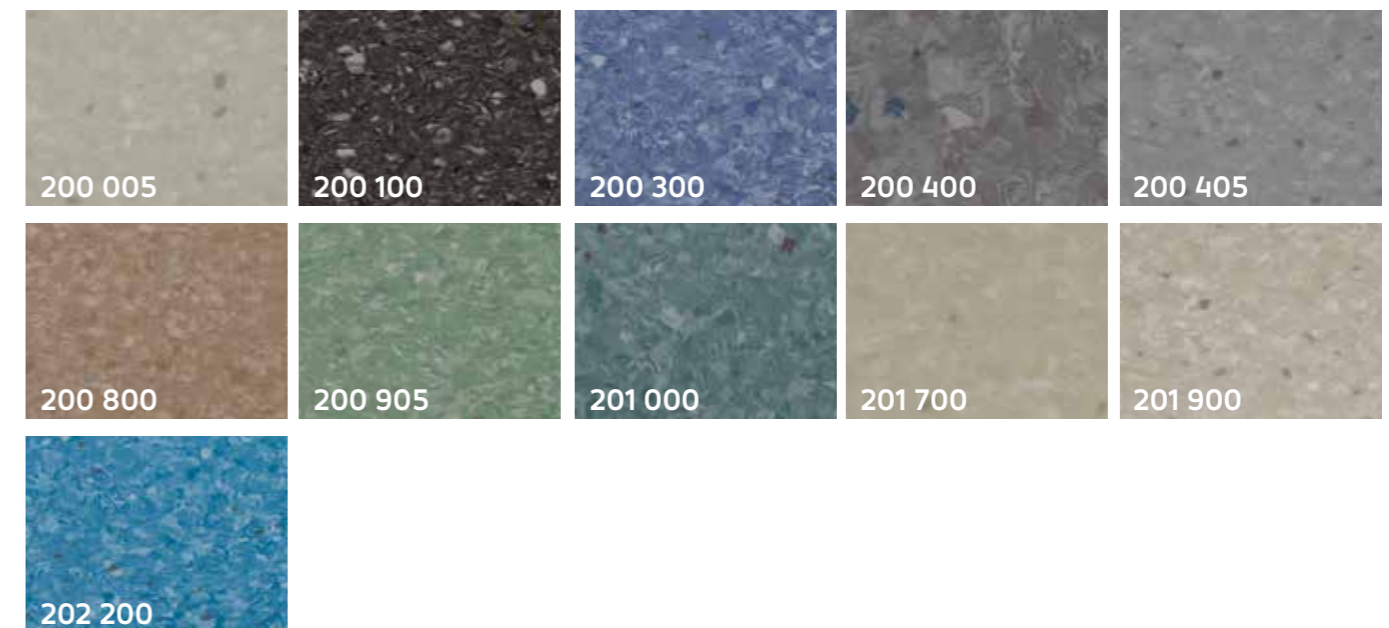

\*\* Real products may differ from above images. Please kindly note to ask for real products samples before confirming your order.

\*\* Gerçek ürünler yukarıdaki resimlerden farklı olabilir. Lütfen siparişinizi vermeden önce gerçek ürün numunelerini istemeyi unutmayın.

\*\* Реальные продукты могут отличаться от изображений выше. Пожалуйста, обратитесь внимание, чтобы запросить образцы реальной продукции перед подтверждением вашего заказа.

For Moderate Commercial Areas

Orta Düzey Ticari Alanlar İçin

Многослойный компактный  
виниловый пол

## TIRETS ( 220 / 221 )



## MODERNO ( 110 / 111 )

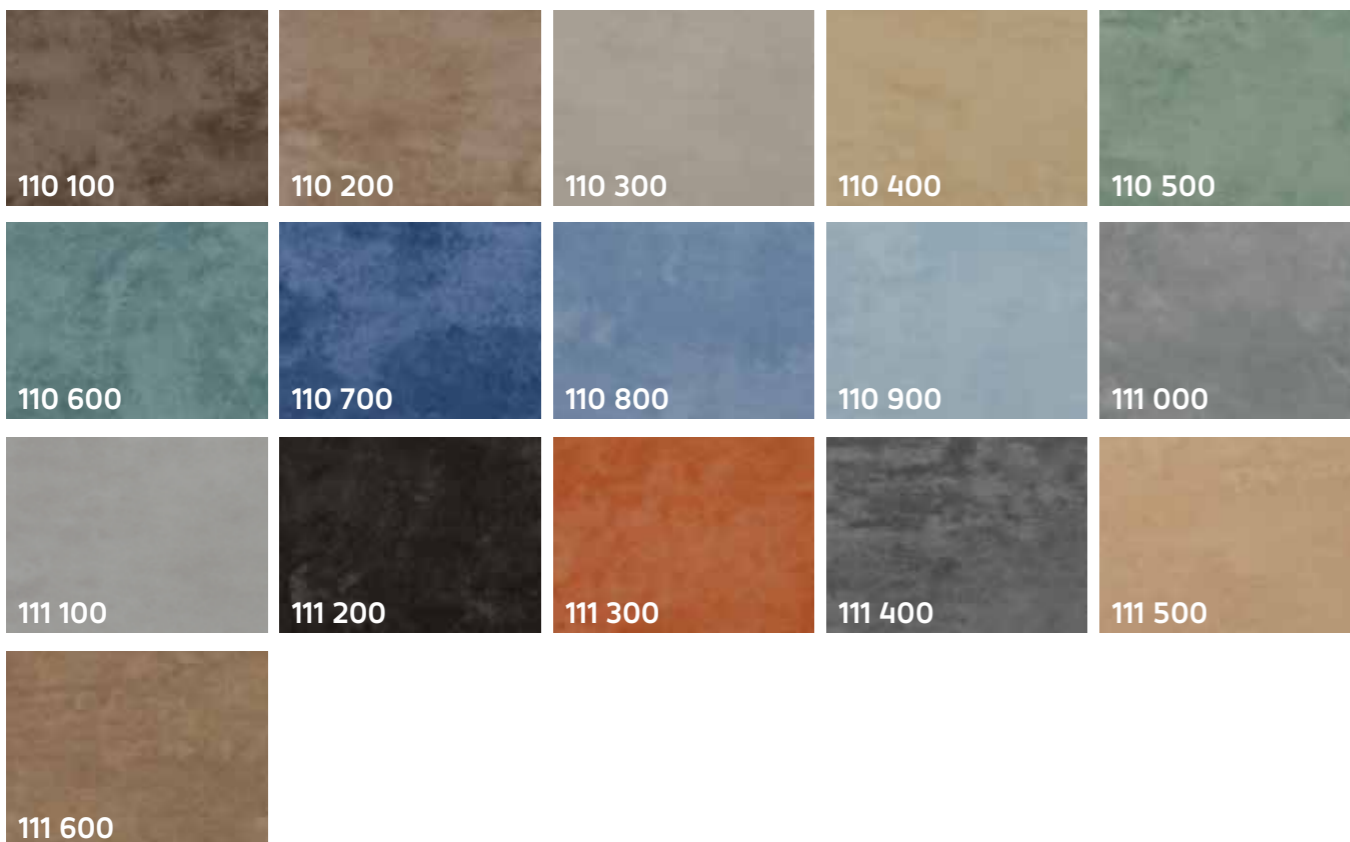

\*\* Real products may differ from above images. Please kindly note to ask for real products samples before confirming your order.

\*\* Gerçek ürünler yukarıdaki resimlerden farklı olabilir. Lütfen siparişinizi vermeden önce gerçek ürün numunelerini istemeyi unutmayın.

\*\* Реальные продукты могут отличаться от изображений выше. Пожалуйста, обратите внимание, чтобы запросить образцы реальной продукции перед подтверждением вашего заказа.

For Moderate Commercial Areas

Orta Düzey Ticari Alanlar İçin

Многослойный компактный  
виниловый пол

## BETONIST ( 210 )



## NEO WOOD ( 150 / 151 )

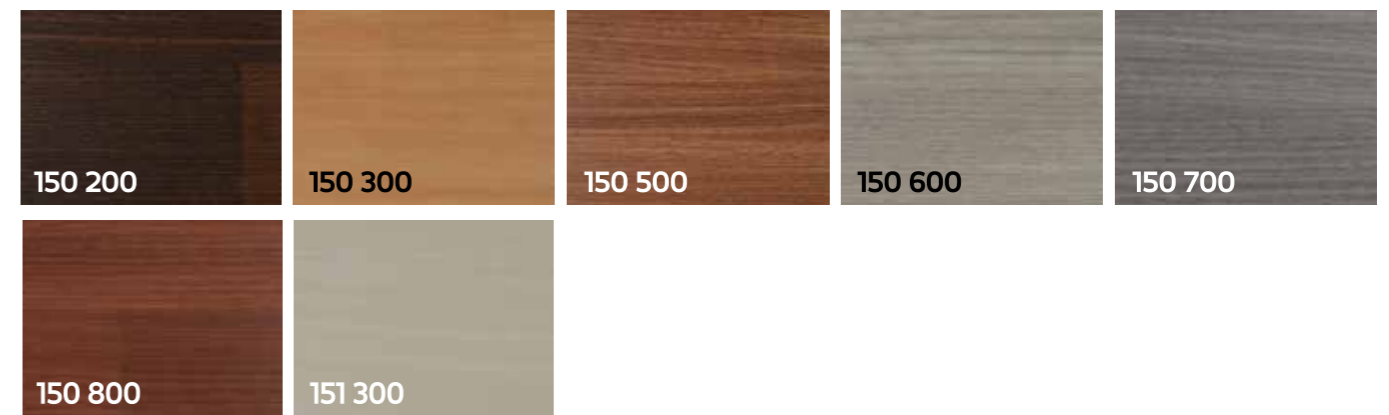

## GAIA ( 100 / 101 )



## TRADITION ( 330 / 331 )

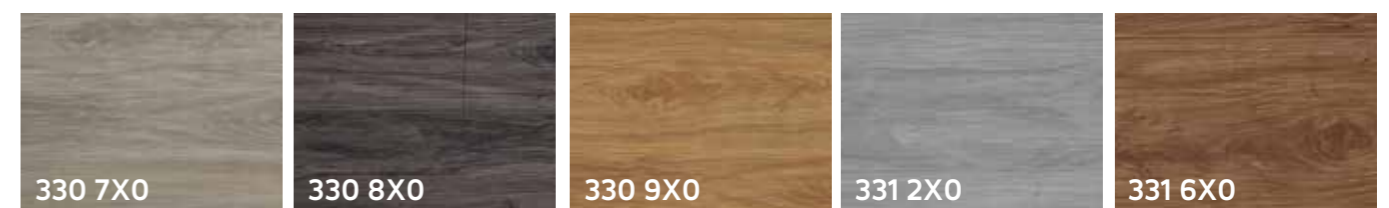

\*\* Real products may differ from above images. Please kindly note to ask for real products samples before confirming your order.

\*\* Gerçek ürünler yukarıdaki resimlerden farklı olabilir. Lütfen siparişinizi vermeden önce gerçek ürün numunelerini istemeyi unutmayın.

\*\* Реальные продукты могут отличаться от изображений выше. Пожалуйста, обратите внимание, чтобы запросить образцы реальной продукции перед подтверждением вашего заказа.

For Moderate Commercial Areas

Orta Düzey Ticari Alanlar İçin

Многослойный компактный  
виниловый пол

## MUNDI ( 296 / 297 )

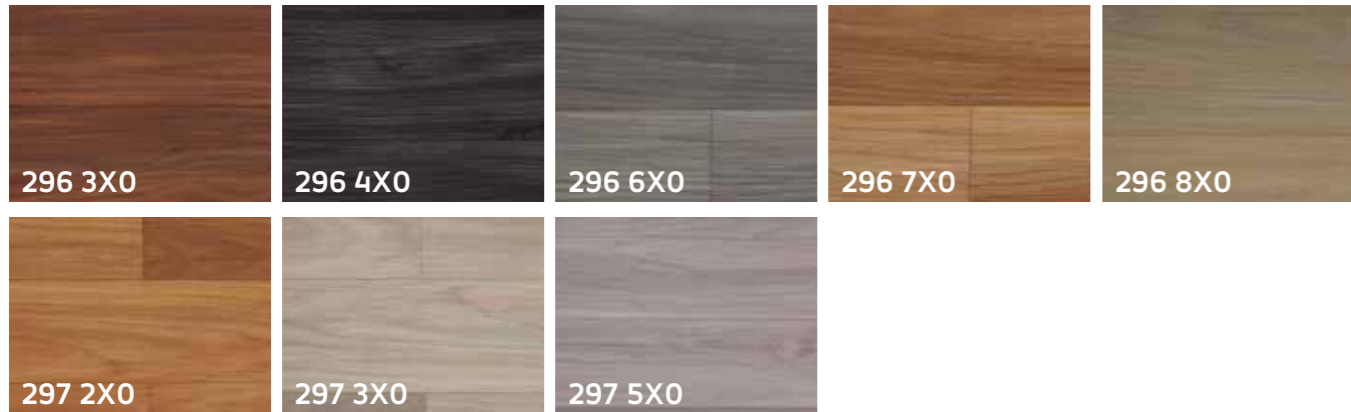

## NEO SAGA ( 231 / 235 / 236 )

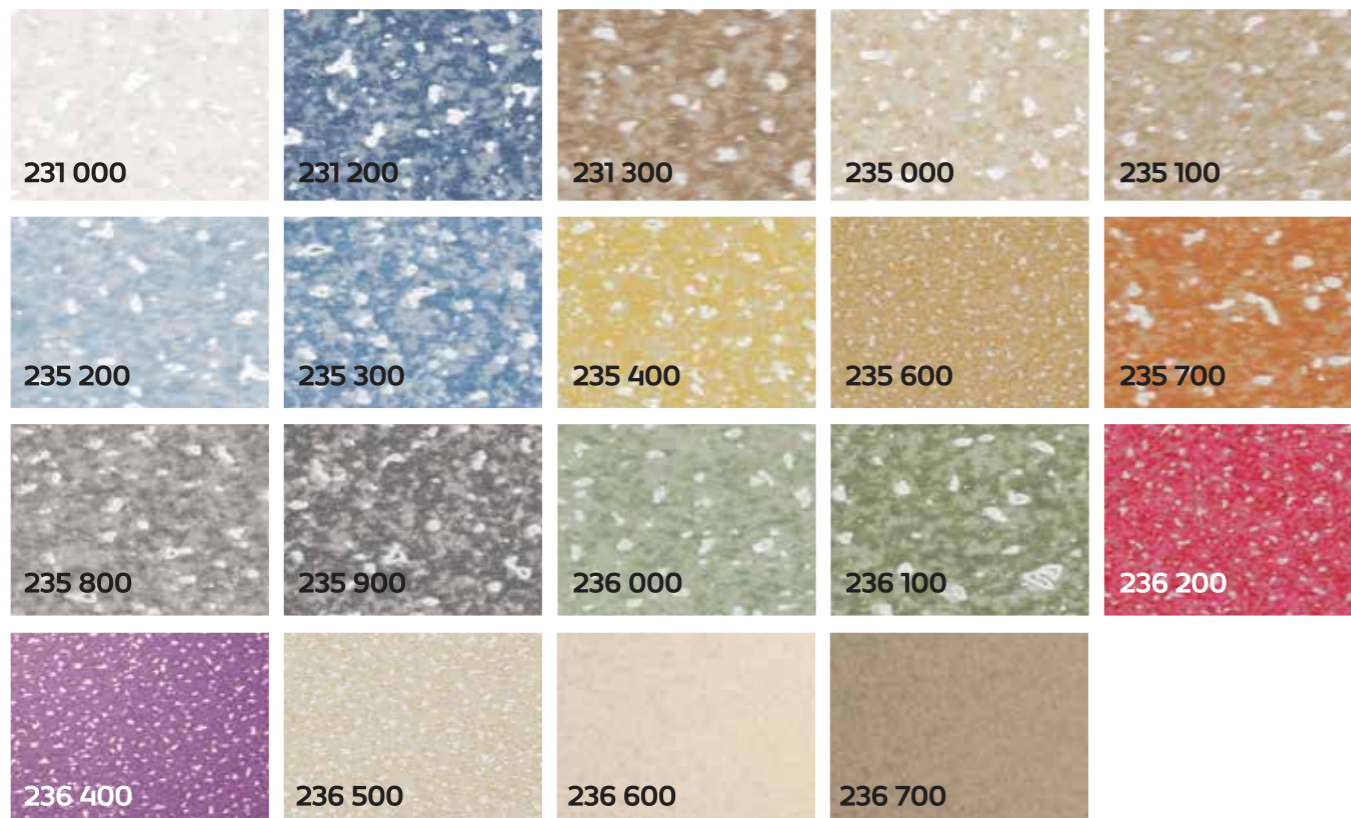

\*\* Real products may differ from above images. Please kindly note to ask for real products samples before confirming your order.

\*\* Gerçek ürünler yukarıdaki resimlerden farklı olabilir. Lütfen siparişinizi vermeden önce gerçek ürün numunelerini istemeyi unutmayın.

\*\* Реальные продукты могут отличаться от изображений выше. Пожалуйста, обратите внимание, чтобы запросить образцы реальной продукции перед подтверждением вашего заказа.

For Moderate Commercial Areas

Orta Düzey Ticari Alanlar İçin

Многослойный компактный  
виниловый пол

## NEO UNACO ( 300 / 301 / 302 )



## SHARPY ( 455 / 456 )



\*\* Real products may differ from above images. Please kindly note to ask for real products samples before confirming your order.

\*\* Gerçek ürünler yukarıdaki resimlerden farklı olabilir. Lütfen siparişinizi vermeden önce gerçek ürün numunelerini istemeyi unutmayın.

\*\* Реальные продукты могут отличаться от изображений выше. Пожалуйста, обратите внимание, чтобы запросить образцы реальной продукции перед подтверждением вашего заказа.

For Moderate Commercial Areas

Orta Düzey Ticari Alanlar İçin

Многослойный компактный  
виниловый пол

## ASSOS ( 560 / 561 )

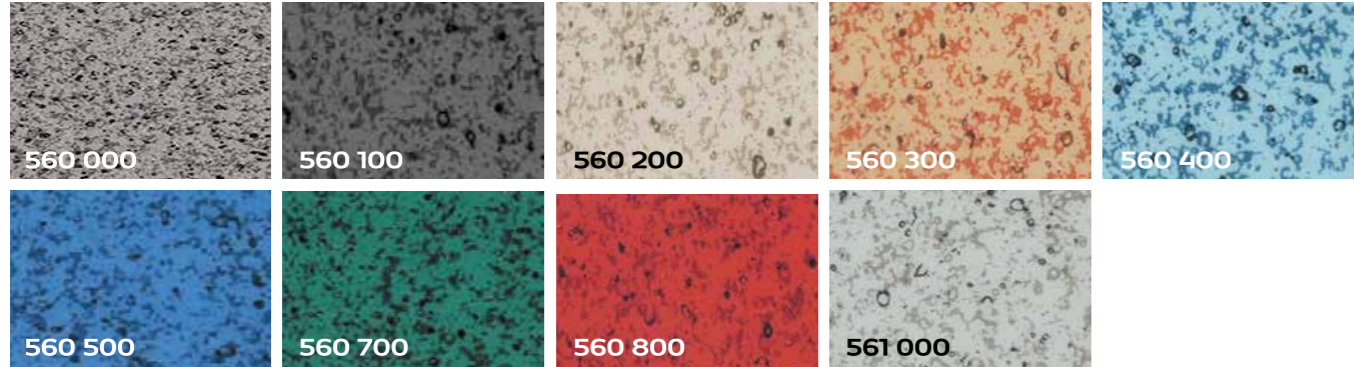

## NEO EFES ( 120 / 121 / 122 )

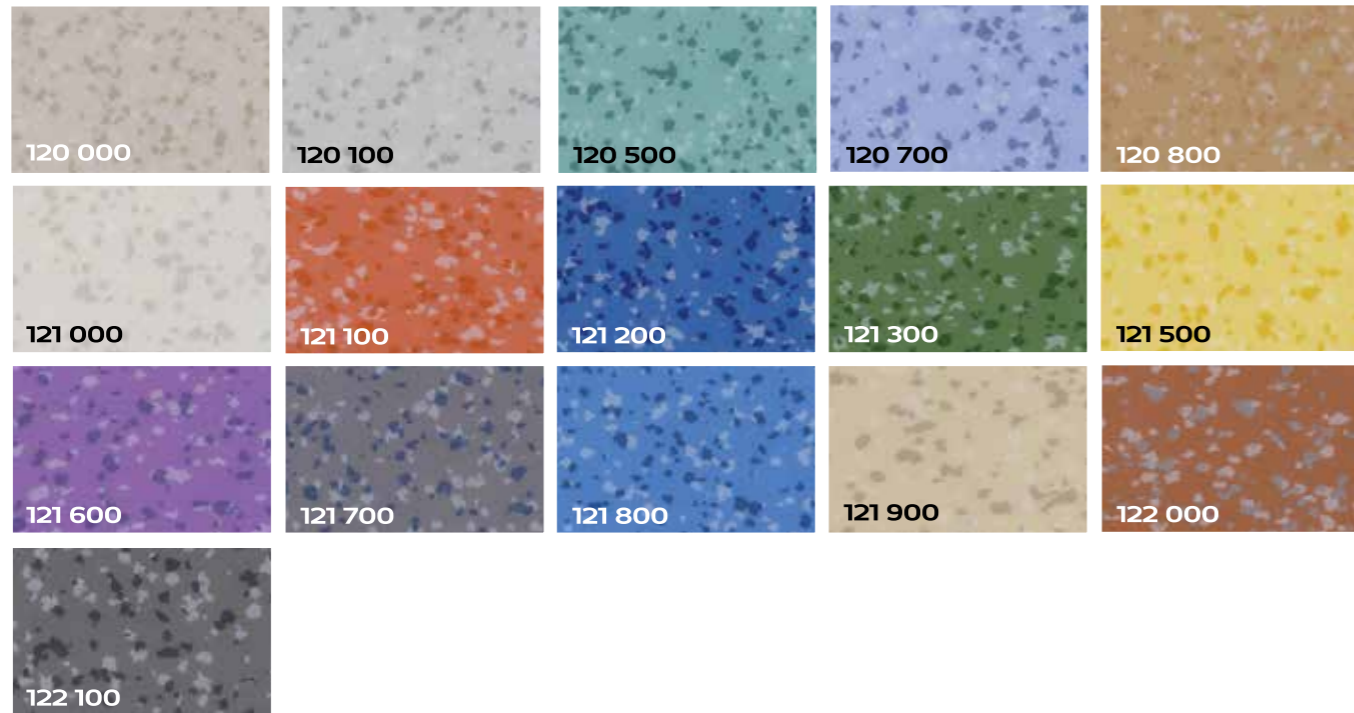

\*\* Real products may differ from above images. Please kindly note to ask for real products samples before confirming your order.

\*\* Gerçek ürünler yukarıdaki resimlerden farklı olabilir. Lütfen siparişinizi vermeden önce gerçek ürün numunelerini istemeyi unutmayın.

\*\* Реальные продукты могут отличаться от изображений выше. Пожалуйста, обратите внимание, чтобы запросить образцы реальной продукции перед подтверждением вашего заказа.

For Moderate Commercial Areas

Orta Düzey Ticari Alanlar İçin

Многослойный компактный  
виниловый пол

## NEO IDEA ( 900 / 901 / 905 )



## MARMARON ( 460 )



\*\* Real products may differ from above images. Please kindly note to ask for real products samples before confirming your order.

\*\* Gerçek ürünler yukarıdaki resimlerden farklı olabilir. Lütfen siparişinizi vermeden önce gerçek ürün numunelerini istemeyi unutmayın.

\*\* Реальные продукты могут отличаться от изображений выше. Пожалуйста, обратите внимание, чтобы запросить образцы реальной продукции перед подтверждением вашего заказа.



EVİKAP

Domestic  
Coverings

Evsel Mekan  
Kaplamları

Покрытия бытового  
назначения

EVİKAP



net  
FLOOR COVERINGS

[www.netfloor.com.tr](http://www.netfloor.com.tr)



## Floor Coverings for Vehicles/ Semi-commercial Floor Coverings



## Araç Zemin Kaplamaları/ Yarı Ticari Zemin Kaplamaları



## Автомобильные напольные покрытия/ Легкие коммерческие помещения



- It is a semi-commercial floor covering suitable for your vehicles and light commercial spaces and domestic use.
- Has a compact structure that is also reinforced with a special textile (TX300B).
- Supports heat and sound insulation thanks to TX300B.
- Thanks to the TX300B, it can be easily applied in vehicle cabin applications.
- It is durable and long-lasting with its calendered compact structure.
- Has specially developed polyurethane PURGUARD protection on its top surface.
- Can easily be cleaned with simple detergents thanks to PURGUARD.
- Is extra resistant to scratches by the help of PURGUARD.
- Is easy to install floor covering with its flexible structure.
- Is environment- friendly and % 100 recyclable.
- Does not include myth as textile-based coverings like carpets.
- Its calendered PVC layer enables mop-cleaning.
- Thanks to the textile base underneath, it minimizes surface defects.
- It is more resistant to abrasion with the calendered film layer on it.
- Standard products are manufactured from recycled PVC. Therefore, the chemical properties, including burning behavior, due to the chemicals they contain, are not guaranteed.
- Optionally produced EvKap Virgin is manufactured solely using original PVC raw material, without any recycled PVC content. Thus, the chemical behaviors, including the chemicals contained and the burning class, can be declarable.

- Araç zeminleri, hafif ticari mekanlar ve evsel alanlarda kullanıma uygun yarı ticari bir zemin kaplamasıdır.
- PVC esaslı kompakt yapısı özel bir keçe (TX300B) ile takviye edilmiştir.
- TX300B sayesinde ısı ve ses izolasyonuna katkıda bulunur.
- TX300B sayesinde araç içi kabin uygulamalarında kullanıma uygundur.
- Kalenderlenmiş kompakt yapısı ile mukavim ve uzun ömürlüdür.
- En üst yüzeyinde özel olarak geliştirilmiş poliüretan PURGUARD yüzey koruması mevcuttur.
- PURGUARD sayesinde en basit temizleyiciler ile kolayca temizlenebilir.
- PURGUARD sayesinde çizilmelere karşı ekstra mukavimdir.
- Esnek yapısıyla uygulaması kolay bir zemin kaplamasıdır.
- Çevre dostudur ve %100 geri dönüşümlü bir malzemedir.
- Halı gibi tekstil esaslı zemin kaplama malzemelerinden farklı olarak myth barındırmaz.
- Üst yüzeyindeki kalenderlenmiş PVC katmanı moplu temizliğe olanak verir.
- Altındaki tekstil tabanı sayesinde alt zemindeki yüzey hatalarının daha az dikkat çekmesini sağlar.
- Kalenderlenmiş aşınma tabakası sayesinde aşınmalara karşı dirençlidir.
- Standart ürünler geri dönüştürülmüş PVC'den üretilir. Bu sebeple, içerdikleri kimyasallar ile yanma davranışı dahil kimyasal özellikleri taahhüt altında değildir.
- Opsiyonel olarak üretilen EvKap Virgin sadece orijinal PVC ham maddesi kullanılarak, geri dönüştürülmüş PVC içeriği bulunmaksızın üretilir. Böylece, içerdikleri kimyasallar ve yanma sınıfı dahil kimyasal davranışlar taahhüt altına alınabilir.

- Это полукоммерческое напольное покрытие, подходящее для ваших автомобилей, небольших коммерческих помещений и домашнего использования.
- Компактная конструкция на основе ПВХ армирована специальным войлоком (TX300B).
- Способствует тепло- и звукоизоляции благодаря TX300B.
- Благодаря TX300B его можно легко применять в салоне автомобиля.
- Он более прочен и долговечен благодаря своей сжатой компактной структуре.
- На ее верхней поверхности находится специально разработанная полиуретановая защита PURGUARD.
- Благодаря PURGUARD его можно легко очистить простейшими чистящими средствами.
- Он особенно устойчив к царапинам благодаря PURGUARD.
- Это напольное покрытие, которое легко укладывается благодаря своей гибкой структуре.
- Он экологически чистый и на 100% пригоден для вторичной переработки.
- В отличие от напольных материалов на текстильной основе, таких как ковер, он не содержит мифов.
- Сжатый слой чистого ПВХ на его верхней поверхности позволяет мыть шваброй.
- Благодаря нижней текстильной основе минимизирует дефекты поверхности.
- Он более устойчив к истиранию благодаря слою пленки на нем.
- Химическая структура стандартной версии не прослеживается из-за переработанного содержимого.
- Девственная структура не является обязательной.



## Layer Diagrams



## Katman Şemaları



## Диаграммы слоев

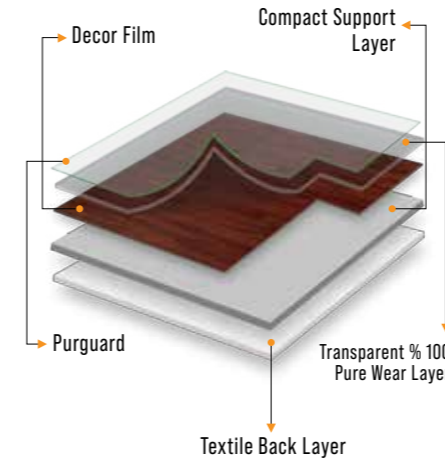

"Some products may use a different product architecture than the illustration above."

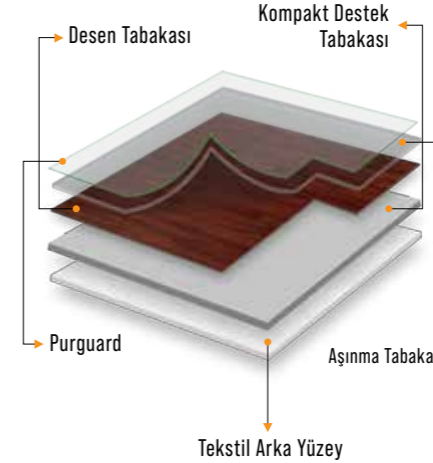

"Kimi ürünlerde, yukarıdaki gösterimden farklı ürün mimarisi kullanılabilir."

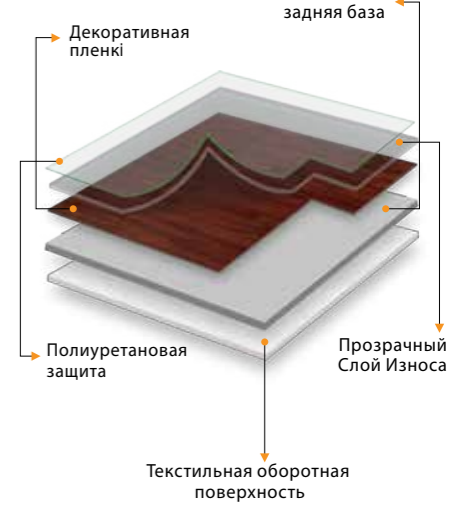

"Некоторые продукты могут использовать архитектуру продукта, отличную от той, что показана на рисунке выше."



PURGUARD : OK

## TECHNICAL DATA SHEET

Product Group: EVKAP

## TECHNICAL PROPERTIES

SPECIFICATION	STANDARD	PRODUCT					
Total Thickness	EN ISO 24346	2 mm (min:-0.10 mm max: 0.13 mm)	2 mm (min:-0.10 mm max: 0.13 mm)	2.30 mm (min:-0.10 mm max: 0.13 mm)	2.30 mm (min:-0.10 mm max: 0.13 mm)	2.50 mm (min:-0.10 mm max: 0.13 mm)	2.50 mm (min:-0.10 mm max: 0.13 mm)
Total Weight	EN ISO 23997	2050 g/m <sup>2</sup> (max:+%13 min: -%10)	2030 g/m <sup>2</sup> (max:+%13 min: -%10)	2545 g/m <sup>2</sup> (max:+%13 min: -%10)	2375 g/m <sup>2</sup> (max:+%13 min: -%10)	2870 g/m <sup>2</sup> (max:+%13 min: -%10)	2800 g/m <sup>2</sup> (max:+%13 min: -%10)
Wear Layer Thickness	EN ISO 24340	0.15 mm (max:+%13 min: -%10)	0.30 mm (max:+%13 min: -%10)	0.15 mm (max:+%13 min: -%10)	0.30 mm (max:+%13 min: -%10)	0.15 mm (max:+%13 min: -%10)	0.30 mm (max:+%13 min: -%10)
Roll Width	EN ISO 24341	2 m	2 m	2 m	2 m	2 m	2 m
Roll Length	EN ISO 24341	24 m	24 m	24 m	24 m	24 m	24 m
PERFORMANCE							
Wear Group	EN 660-2	Group T	Group T	Group T	Group T	Group T	Group T
Test for Color Fastness	EN ISO 105-B02	≥6	≥6	≥6	≥6	≥6	≥6
Dimensional Stability	EN ISO 23999	≤%0.4	≤%0.4	≤%0.4	≤%0.4	≤%0.4	≤%0.4
Residual Indentation	EN ISO 24343-1	≤0.1 mm	≤0.1 mm	≤0.1 mm	≤0.1 mm	≤0.1 mm	≤0.1 mm
Flexibility	EN ISO 24344	No Crack	No Crack	No Crack	No Crack	No Crack	No Crack
Slip Resistance	EN 13893	DS	DS	DS	DS	DS	DS
	EN 16165	R10 (Optional)	R10 (Optional)	R10 (Optional)	R10 (Optional)	R10 (Optional)	R10 (Optional)

In case, you otherwise specify, standard EvKap products are produced with recycled PVC ingredients which the chemical history is not certified and is accepted as unknown. The chemical structure, ingredients, and chemical behaviors, including fire behavior, cannot be warranted and are not

declarable because of this recycled PVC content. However, is an optional variant and is produced with only virgin raw material

ingredients, and thus its chemical structure and chemical behaviors, including fire behavior, is totally declarable. Please kindly contact your supplier for further information.

\* Sipariş geçmeden önce, lütfen güncel TDS verilerini talep edin.

\* Before placing an order, please request up-to-date TDS data.

Resistance	✓	✓
Sound & Heat Insulation	✓	✓
Cleaning & Hygiene	✓	✓
Scratch Resistance	✓	✓
Flexibility	✓	✓
100% Recyclable	✓	✓
Underfoot Comfort	✓	✓
Recycled Content	✓	✗
Chemical Behavior Warranty	✗	✓
Chemical Structure Warranty	✗	✓
Horizontal Burning Warranty	✗	✓
Burning Warranty	✗	✓
CE	✗	✓
Price	\$	\$ \$

Domestic Coverings

Evsel Mekan Kaplamaları

Покрyтия бытового назначения

## TEAKY ( 500 )



## GAIA ( 100 / 101 / 102 )



## VEGA ( 890 / 891 )

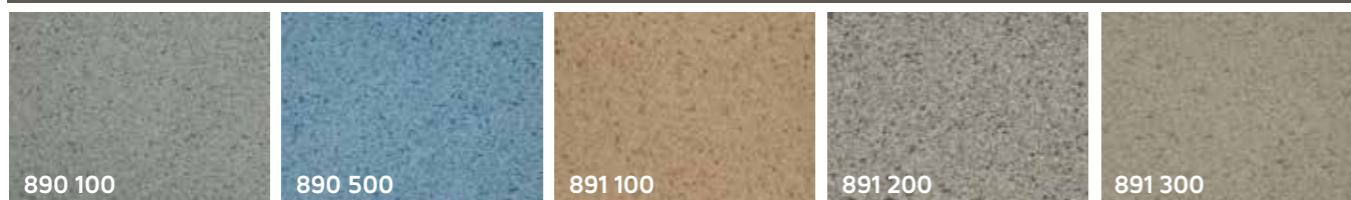

## STONETTE ( A00 )

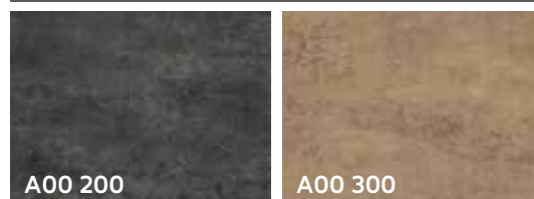

Domestic Coverings

Evsel Mekan Kaplamaları

Покрyтия бытового назначения

## COACHWOOD ( 520 / 521 )



## REIS ( 570 )

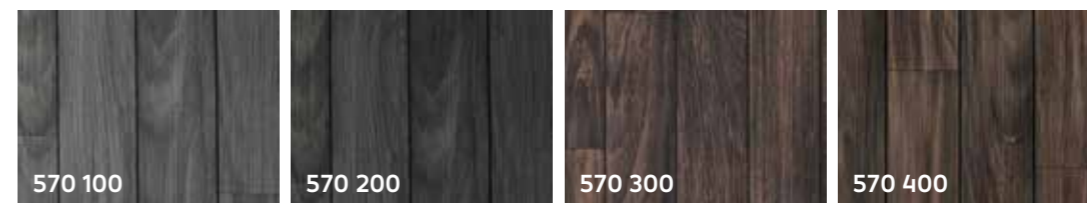

\*\* Real products may differ from above images. Please kindly note to ask for real products samples before confirming your order.

\*\* Gerçek ürünler yukarıdaki resimlerden farklı olabilir. Lütfen siparişinizi vermeden önce gerçek ürün numunelerini istemeyi unutmayın.

\*\* Реальные продукты могут отличаться от изображений выше. Пожалуйста, обратите внимание, чтобы запросить образцы реальной продукции перед подтверждением вашего заказа.

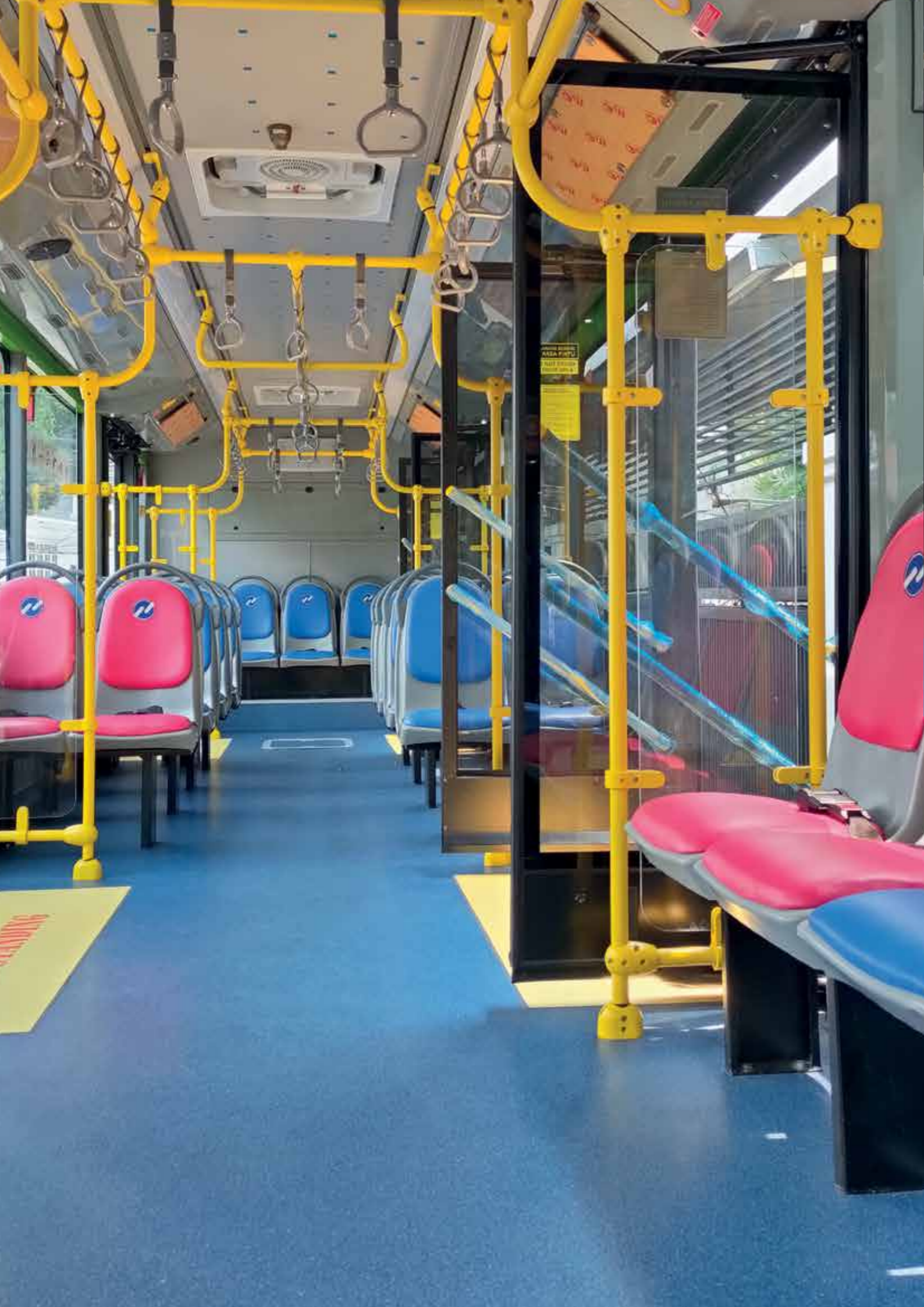

BUSKOP

Transport Safety  
Flooring

Araç İçi Güvenlikli  
Zemin Kaplamaları

Транспортная безопасность  
Напольное покрытие

**BUSKOP**



**net**  
FLOOR COVERINGS

[www.netfloor.com.tr](http://www.netfloor.com.tr)



## Transport Safety Flooring



## Araç İçi Güvenlikli Zemin Kaplamaları



## Транспортная безопасность Напольное покрытие



• Buskap is Net Floor Covering's transport flooring series that is designed for Bus and Coach manufacturers.

• Buskap is a durable floor covering with its improved abrasion resistance supplied by its suspension PVC based structure.

• Thanks to its polyurethane based surface treatment technology, Buskap's cleaning and hygiene efficiency is increased.

• Thanks to its glass-fibre embedded architecture, Buskap is a floor covering with maximum dimensional stability and so it can warrant the same performance values under different seasonal conditions.

• Buskap is totally phthalate-free and being manufactured by using the new generation plasticiser.

• Thanks to its supplement with the new generation of textile backings, Buskap's flexibility and adherence capacity is increased to supply enough application flexibility that will serve for different levels of architectural solutions in a vehicle cabine.

• Thanks to its glass fibre and new generation of textile backing added structure, Buskap is a lighter floor covering than most of the coverings at same thickness and so aims to contribute to fuel-economy and CO2 emissions of the vehicle.

• Buskap, Net Zemin kaplamaları'nın otobüs, minibüs ve midibüs araç üreticilerine dönük olarak tasarladığı profesyonel araç içi zemin kaplama serisidir.

• Süspansiyon PVC kullanılarak artırılmış aşınma direnci ile BusKap, uzun ömürlü bir zemin kaplamasıdır.

• Poliüretan esaslı yüzey kaplama teknolojisi sayesinde BusKap'ın temizlik ve hijyen etkinliği artırılmıştır.

• Buskap cam elyaf takviyesi sayesinde maksimum boyutsal kararlılığa sahip bir zemin kaplaması olarak farklı iklim koşullarında da aynı performans değerlerini sağlamayı garanti etmektedir.

• Buskap, yeni nesil plastifiyanlar ile tamamen fitalatsız olarak üretilmektedir.

• Yeni nesil özel tekstil tabanı sayesinde esnekliği ve yapışma kabiliyeti artırılmış. Buskap farklı düzeylerde araç içi mimari çözümlere olanak verecek yeterli uygulama esnekliğine sahiptir.

• Cam elyafı ve yeni nesil özel tekstil tabanı sayesinde eş kalınlıktaki çoğu ürünlere göre hafifletilmiş bir zemin kaplaması BusKap yakıt ekonomisi CO2 emisyonlarına katkı sağlama amacındadır.

• Напольное покрытие BusKap – серия профессионального покрытия для полов салонов автотранспортных средств, разработанная специально для производителей автобусов, микроавтобусов и мидибусов.

• Высокий уровень износоустойчивости, обеспечиваемый за счет использования в процессе производства Суспензионного поливинилхлорида (ПВХ), делает покрытие BusKap долговечным и сверхпрочным напольным покрытием.

• Благодаря особенностям промышленной технологии поверхностных покрытий на основе полиуретана, влажная очистка и гигиеническая обработка покрытий BusKap более эффективна.

• Покрытие BusKap изготавливается с добавлением пластификатов нового поколения и совершенно без применения фталатов.

• Благодаря специальной текстильной подложке нового поколения, улучшены характеристики эластичности и адгезии покрытия к основанию. BusKap обладает достаточной пластичностью, что облегчает укладку материала, и, как следствие, обеспечивает широкий спектр возможностей для реализации разнообразных архитектурных решений для внутренних поверхностей транспортных средств.

• Облегченность по весу покрытия BusKap по сравнению с другими покрытиями одинаковой толщины, достигаемая путем применения стекловолокна и специального текстильного основания нового поколения, имеет своей целью способствовать экономии топлива и соответственно, сокращению выхлопов CO2 в атмосферу.



## Layer Diagrams

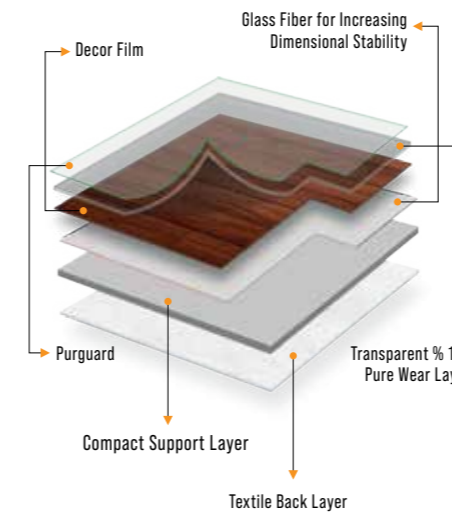

"Some products may use a different product architecture than the illustration above."



## Katman Şemaları

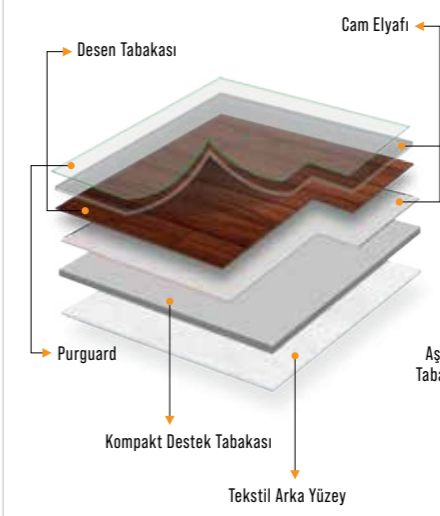

"Kimi ürünlerde, yukarıdaki gösterimden farklı ürün mimarisi kullanılabilir."



## Диаграммы слоев

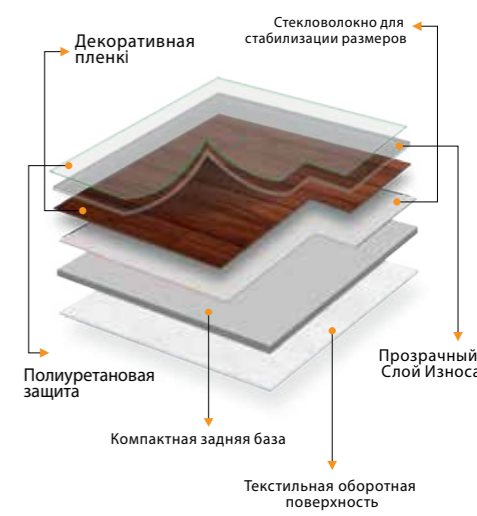

"Некоторые продукты могут использовать архитектуру продукта, отличную от той, что показана на рисунке выше."



GLASS FIBER TISSUE : OK  
PURGUARD : OK

## TECHNICAL DATA SHEET

PRODUCT IDENTIFICATION : BUSKAP

## TECHNICAL PROPERTIES

DESCRIPTION	STANDARD	UNIT	PRODUCT					
			NEOWOOD	SOMBRE	STARETTE	GENTIL	CIRCUIT	ELEGANCE
Design			TX150B	TX150B	TX150B	TX150B	TX150B	TX150B
Back Layer			TX150B	TX150B	TX150B	TX150B	TX150B	TX150B
Total Thickness	EN ISO 24346	mm	2.00	2.25	2.25	2.25	2.25	2.25
Wear Layer Thickness	EN ISO 24340	mm	0.50	0.50	0.50	0.50	0.50	0.50
Unit Area Mass	EN ISO 23997	g/m <sup>2</sup>	2330	2635	2635	2635	2635	2635
Roll Width	EN ISO 24341	m	2	2	2	2	2	2
Roll Length	EN ISO 24341	m	20-24	20-24	20-24	20-24	20-24	20-24
Emboss			FR	FR	FR	DH	DH	DH
PERFORMANCE								
Wear Group	EN 660-2		Group T	Group T	Group T	Group T	Group T	Group T
Binder Content	ISO 10582		Type 1	Type 1	Type 1	Type 1	Type 1	Type 1
Effect of a Castor Chair	ISO 4918		No deformation after 25.000 cycles	No deformation after 25.000 cycles	No deformation after 25.000 cycles	No deformation after 25.000 cycles	No deformation after 25.000 cycles	No deformation after 25.000 cycles
Color Fastness	EN ISO 105-B02		≥6	≥6	≥6	≥6	≥6	≥6
Dimensional Stability	EN ISO 23999	%	≤%0.4	≤%0.4	≤%0.4	≤%0.4	≤%0.4	≤%0.4
Curling	EN ISO 23999	mm	≤8mm	≤8mm	≤8mm	≤8mm	≤8mm	≤8mm
Residual Indentation	EN ISO 24343-1	mm	≤0.1 mm	≤0.1 mm	≤0.1 mm	≤0.1 mm	≤0.1 mm	≤0.1 mm
Flexibility	EN ISO 24344		No Crack	No Crack	No Crack	No Crack	No Crack	No Crack
Evaluation of the Action of Microorganisms	EN ISO 846 METOD C		0	0	0	0	0	0
Fire Resistance	EN 13501-1	Bfl	Bfl S1	Bfl S1	Bfl S1	Bfl S1	Bfl S1	Bfl S1
Electrical Property	EN 1815	kV	≤2kV Antistatic	≤2kV Antistatic	≤2kV Antistatic	≤2kV Antistatic	≤2kV Antistatic	≤2kV Antistatic
Thermal Conductivity	EN 12667	m2K/W	0,0423 (m2K/W)	0,0423 (m2K/W)	0,0423 (m2K/W)	0,0423 (m2K/W)	0,0423 (m2K/W)	0,0423 (m2K/W)
Slip Resistance	EN 16165		R10	R10	R10	R10	R10	R10
	EN 13893		DS	DS	DS	DS	DS	DS
Formaldehyde Emission	EN 717-1	mg/m <sup>3</sup> ppm	Class E1	Class E1	Class E1	Class E1	Class E1	Class E1
Ball Drop Test	M3229		KF1 No Break	KF1 No Break	KF1 No Break	KF1 No Break	KF1 No Break	KF1 No Break
Hot light Fastness Test	EN ISO 105-B06		4	4	4	4	4	4
Determination Of Staining and Resistance To Chemical	EN ISO 26987		Ok	Ok	Ok	Ok	Ok	Ok
Horizontal Burning Rate	ECE R 118.04		Ok	Ok	Ok	Ok	Ok	Ok
	FMVSS No. 302		Ok	Ok	Ok	Ok	Ok	Ok
Odour Test	VDA270 C2		≤3	≤3	≤3	≤3	≤3	≤3

\* Sipariş geçmeden önce, lütfen güncel TDS verilerini talep edin.

\* Before placing an order, please request up-to-date TDS data.

GLASS FIBER TISSUE : OK  
PURGUARD : OK

## TECHNICAL DATA SHEET

PRODUCT IDENTIFICATION : BUSKAP

## TECHNICAL PROPERTIES

DESCRIPTION	STANDARD	UNIT	PRODUCT					
			STONETTE	MAESTRO	DIGIKAP BUS	BUSWOOD	CAPTAIN	TRADITION
Design			TX150B	TX150B	TX150B	TX150B	TX150B	TX150B
Back Layer			TX150B	TX150B	TX150B	TX150B	TX150B	TX150B
Total Thickness	EN ISO 24346	mm	2.25	2.50	2.50	2.70	3	3
Wear Layer Thickness	EN ISO 24340	mm	0.60	0.50	0.70	0.70	0,6	1
Unit Area Mass	EN ISO 23997	g/m <sup>2</sup>	2395	2810	2750	3045	3535	3750
Roll Width	EN ISO 24341	m	2	2	2	2	2	2
Roll Length	EN ISO 24341	m	20-24	20-24	20-24	20-24	20-24	20-24
Emboss			DH	PR	PR	KB	P1	FR
PERFORMANCE								
Wear Group	EN 660-2		Group T	Group T	Group T	Group T	Group T	Group T
Binder Content	ISO 10582		Type 1	Type 1	Type 1	Type 1	Type 1	Type 1
Effect of a Castor Chair	ISO 4918		No deformation after 25.000 cycles	No deformation after 25.000 cycles	No deformation after 25.000 cycles	No deformation after 25.000 cycles	No deformation after 25.000 cycles	No deformation after 25.000 cycles
Color Fastness	EN ISO 105-B02		≥6	≥6	≥6	≥6	≥6	≥6
Dimensional Stability	EN ISO 23999	%	≤%0.4	≤%0.4	≤%0.4	≤%0.4	≤%0.4	≤%0.4
Curling	EN ISO 23999	mm	≤8mm	≤8mm	≤8mm	≤8mm	≤8mm	≤8mm
Residual Indentation	EN ISO 24343-1	mm	≤0.1 mm	≤0.1 mm	≤0.1 mm	≤0.1 mm	≤0.1 mm	≤0.1 mm
Flexibility	EN ISO 24344		No Crack	No Crack	No Crack	No Crack	No Crack	No Crack
Evaluation of the Action of Microorganisms	EN ISO 846 METOD C		0	0	0	0	0	0
Fire Resistance	EN 13501-1	Bfl	Bfl S1	Bfl S1	Bfl S1	Bfl S1	Bfl S1	Bfl S1
Electrical Property	EN 1815	kV	≤2kV Antistatic	≤2kV Antistatic	≤2kV Antistatic	≤2kV Antistatic	≤2kV Antistatic	≤2kV Antistatic
Thermal Conductivity	EN 12667	m2K/W	0,0423 (m2K/W)	0,0423 (m2K/W)	0,0423 (m2K/W)	0,0423 (m2K/W)	0,0423 (m2K/W)	0,0423 (m2K/W)
Slip Resistance	EN 16165		R10 (R12 Optional)	R10 (R12 Optional)	R10	R10	R10	R10
	EN 13893		DS	DS	DS	DS	DS	DS
Formaldehyde Emission	EN 717-1	mg/m <sup>3</sup> ppm	Class E1	Class E1	Class E1	Class E1	Class E1	Class E1
Ball Drop Test	M3229		KF1 No Break	KF1 No Break	KF1 No Break	KF1 No Break	KF1 No Break	KF1 No Break
Hot light Fastness Test	EN ISO 105-B06		4	4	4	4	4	4
Determination Of Staining and Resistance To Chemical	EN ISO 26987		Ok	Ok	Ok	Ok	Ok	Ok
Horizontal Burning Rate	ECE R 118.04		Ok	Ok	Ok	Ok	Ok	Ok
	FMVSS No. 302		Ok	Ok	Ok	Ok	Ok	Ok
Odour Test	VDA270 C2		≤3	≤3	≤3	≤3	≤3	≤3

\* Sipariş geçmeden önce, lütfen güncel TDS verilerini talep edin.

\* Before placing an order, please request up-to-date TDS data.

Transport Safety Flooring

Araç İçi Güvenlikli Zemin Kaplamaları

Транспортная безопасность  
Напольное покрытие

## STARETTE ( 380 / 38A )

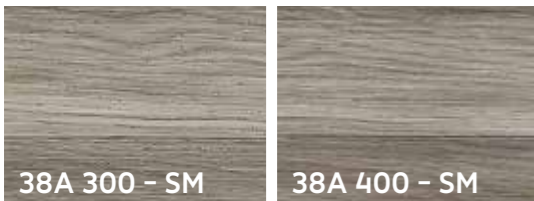

## SOMBRE ( 390 / 39A )

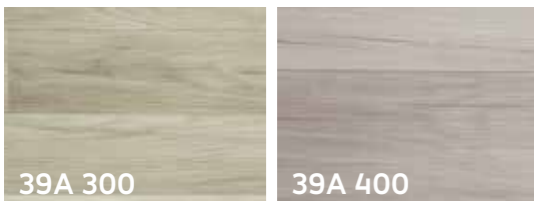

## TRADITION ( 330 / 331 )

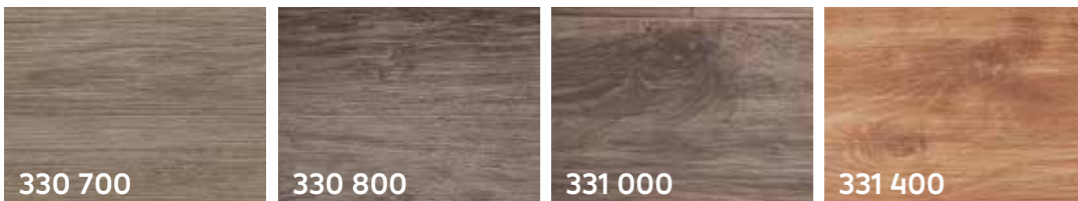

\*\* Real products may differ from above images. Please kindly note to ask for real products samples before confirming your order.

\*\* Gerçek ürünler yukarıdaki resimlerden farklı olabilir. Lütfen siparişinizi vermeden önce gerçek ürün numunelerini istemeyi unutmayın.

\*\* Реальные продукты могут отличаться от изображений выше. Пожалуйста, обратите внимание, чтобы запросить образцы реальной продукции перед подтверждением вашего заказа.

Transport Safety Flooring

Araç İçi Güvenlikli Zemin Kaplamaları

Транспортная безопасность  
Напольное покрытие

## NEOWOOD ( 151 / 150 )

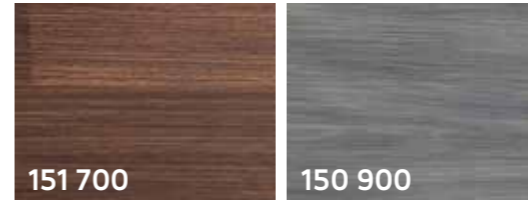

## GALAKSI ( 130 )



## SPARKLED ( 620 )



## STONETTE ( A00 )



## MAESTRO ( 360 )

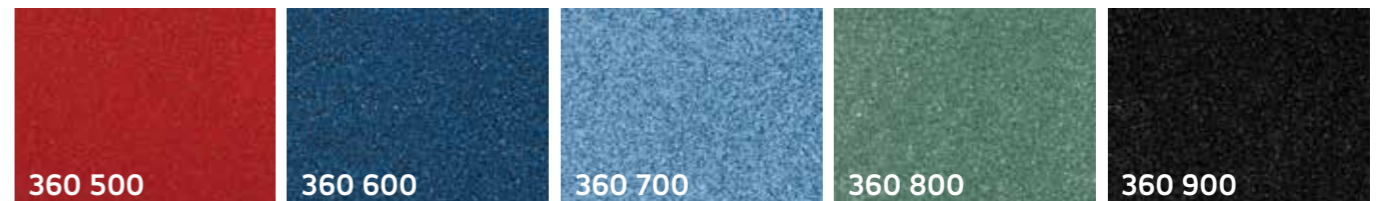
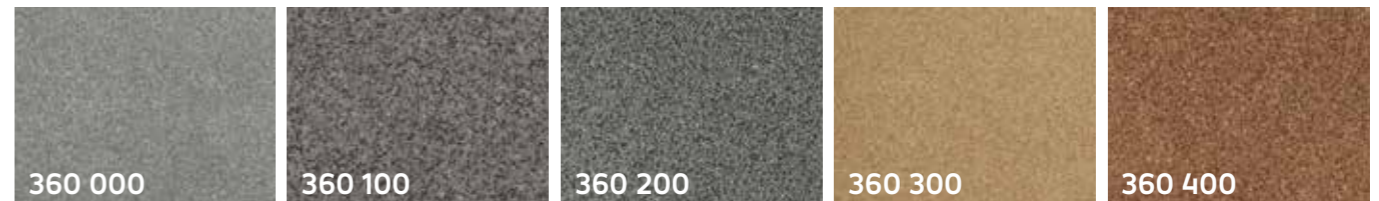

## CAPTAIN ( 240 )

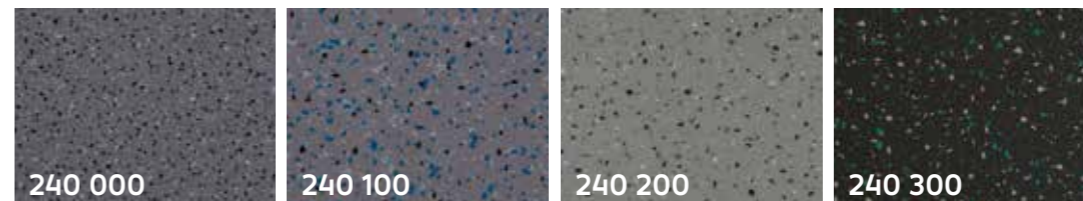

## DIGIKAP BUS



\*\* Real products may differ from above images. Please kindly note to ask for real products samples before confirming your order.

\*\* Gerçek ürünler yukarıdaki resimlerden farklı olabilir. Lütfen siparişinizi vermeden önce gerçek ürün numunelerini istemeyi unutmayın.

\*\* Реальные продукты могут отличаться от изображений выше. Пожалуйста, обратите внимание, чтобы запросить образцы реальной продукции перед подтверждением вашего заказа.

Transport Safety Flooring

Araç İçi Güvenlikli Zemin Kaplamaları

Транспортная безопасность  
Напольное покрытие

## CIRCUIT ( 650 )

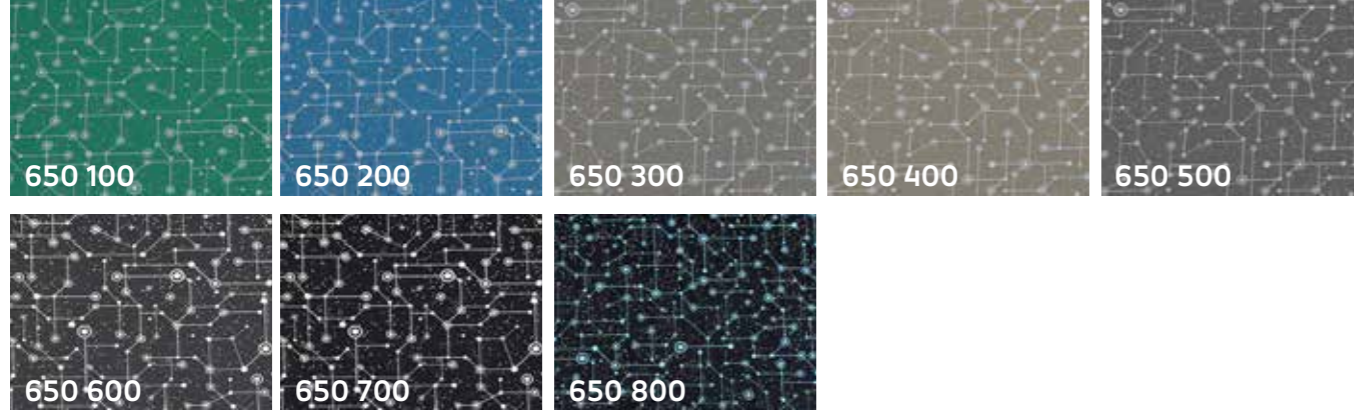

## ELÉGANCE ( 275 )

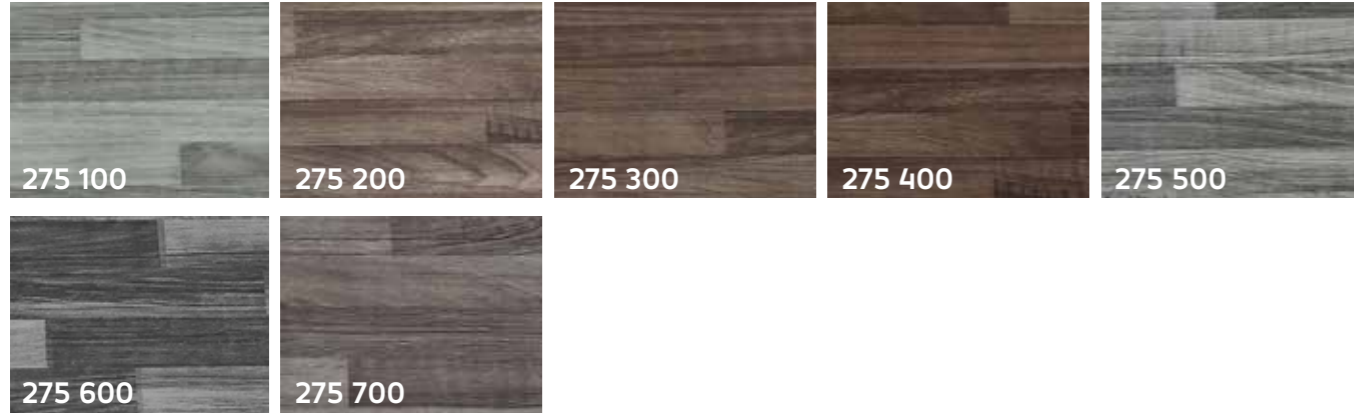

## GENTIL ( 276 )



\*\* Real products may differ from above images. Please kindly note to ask for real products samples before confirming your order.

\*\* Gerçek ürünler yukarıdaki resimlerden farklı olabilir. Lütfen siparişinizi vermeden önce gerçek ürün numunelerini istemeyi unutmayın.

\*\* Реальные продукты могут отличаться от изображений выше. Пожалуйста, обратите внимание, чтобы запросить образцы реальной продукции перед подтверждением вашего заказа.



OTOKAP  
PRINT

Printed Transport  
Floor CoveringsAraç İçi Baskılı  
KaplamlarıАвтомобильные узорные  
напольные покрытия

OTOKAP  
PRINT



net  
FLOOR COVERINGS

www.netfloor.com.tr



## Printed Transport Floor Coverings



## Araç İçi Baskılı Kaplamaları



## Автомобильные узорные напольные покрытия



- Has newly developed polyurethane PURGUARD protection on its top surface.
- Can easily be cleaned with simple change glass thanks to PURGUARD.
- Otokap Print's surface does not change gloss due to heat released out during hot welding
- Supplies elegant look to vehicle floor with its dull surface.
- Prevents defects from undersurface to be noticed easily due to its mat surface
- Has a wide range of colors and patterns thanks to printing technology.
- Otokap-Print has a high cost&quality performance with its four layered structure.
- Can easily stick on different types of surfaces thanks to TX150.
- Otokap Print is a member of T-abrassion class which is the most durable class of PVC floor coverings.
- Otokap Print is convenient for hot welding.

- En üst yüzeyinde yeni geliştirilmiş poliüretan PURGUARD koruması mevcuttur.
- PURGUARD sayesinde en basit temizleyiciler ile kolayca temizlenebilir.
- Sıcak kaynak esnasında oluşan ısı temasında yüzeyi parlamaz.
- PURGUARD'ın sağladığı mat yüzeyi, araç tabanında son derece elegant bir görünüm sunar.
- Mat yüzeyi, araç tabanında işçilik ve malzemeden kaynaklı oluşan hataların yüzeye en az yansımaları sağlar.
- Baskı teknolojisi geniş bir renk, desen yelpazesine sahip olmasına imkan verir.
- Otokap-Print dört katmanlı yapısı ile fiyat-kalite performansı yüksek bir üründür.
- Otokap-Printin özel emici keçe tabanı (TX150) tüm yüzeylere yapışabilir.
- Otokap-Print, zemin kaplamalarının en yüksek aşınma grubu olan T - sınıfındadır.
- Otokap-Print sıcak kaynağa uygundur.

- Обладает новой полиуретановой защитой PURGUARD, разработанной на самом высоком уровне.
- PURGUARD обеспечивает легкую чистку даже самыми простыми чистящими средствами.
- При контакте с тепловыми источниками поверхность не блестит.
- Матовая поверхность PURGUARD придает полу транспортного средства элегантный внешний вид.
- Матовая поверхность обеспечивает минимальное отражение дефектов материалов и трудозатрат на поверхности транспортного средства.
- Печатная технология обеспечивает широкий цветовой диапазон и богатство узоров.
- Otokap-Print является четырехслойным продуктом с высокими рабочими показателями цены-качества.
- Otokap-Print склеивается с любыми поверхностями благодаря специальному впитывающему войлочному основанию (TX150).
- Otokap-Print относится к классу Т, являющемуся наиболее устойчивым к износу среди покрытий.
- Otokap-Print пригоден для горячей сварки.



## Layer Diagrams



## Katman Şemaları



## Диаграммы слоев

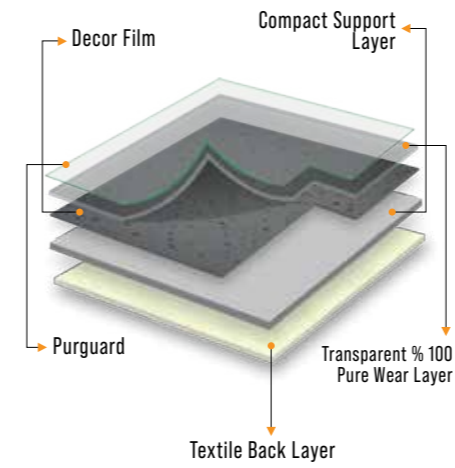

"Some products may use a different product architecture than the illustration above."

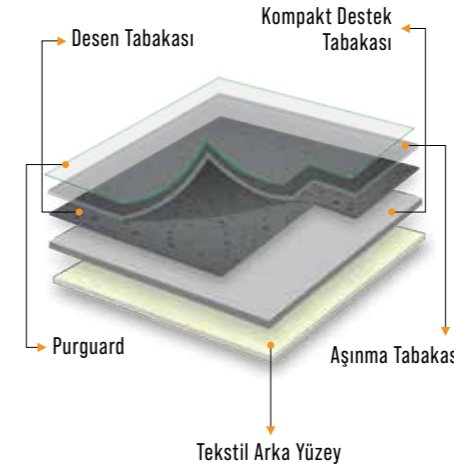

"Kimi ürünlerde, yukarıdaki gösterimden farklı ürün mimarisi kullanılabilir."

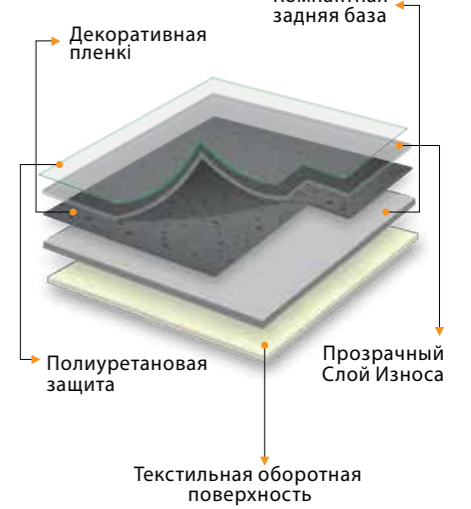

"Некоторые продукты могут использовать архитектуру продукта, отличную от той, что показана на рисунке выше."



PURGUARD : OK

## TECHNICAL DATA SHEET

PRODUCT IDENTIFICATION : OTOKAP PRINT

## TECHNICAL PROPERTIES

DESCRIPTION	STANDARD	UNIT	PRODUCT							
			TX100	TX150	TX150	TX150	TX150	TX150	TX150	TX150
Back Layer			TX100	TX150	TX150	TX150	TX150	TX150	TX150	TX150
Total Thickness	EN ISO 24346	mm	1.20	1.40	1.60	1.80	2	2,2	2	2,2
Wear Layer Thickness	EN ISO 24340	mm	0.15	0.15	0.15	0.15	0.15	0.15	0.30	0.30
Unit Area Mass	EN ISO 23997	g/m <sup>2</sup>	1210	1450	1810	2055	2475	2690	2350	2680
Roll Width	EN ISO 24341	m	2	2	2	2	2	2	2	2
Roll Length	EN ISO 24341	m	18-20	18-20	18-20	18-20	18-20	18-20	18-20	18-20
PERFORMANCE										
Dimensional Stability	EN ISO 23999	%	≤%0.4	≤%0.4	≤%0.4	≤%0.4	≤%0.4	≤%0.4	≤%0.4	≤%0.4
Curling	EN ISO 23999	mm	Max: 8	Max: 8	Max: 8	Max: 8	Max: 8	Max: 8	Max: 8	Max: 8
Tensile Strength Crosswise	EN ISO 527	N/mm <sup>2</sup>	Min: 3 N/mm <sup>2</sup>	Min: 3 N/mm <sup>2</sup>	Min: 3 N/mm <sup>2</sup>	Min: 3 N/mm <sup>2</sup>	Min: 3 N/mm <sup>2</sup>	Min: 3 N/mm <sup>2</sup>	Min: 3 N/mm <sup>2</sup>	Min: 3 N/mm <sup>2</sup>
Tensile strength Lengthwise	EN ISO 527	N/mm <sup>2</sup>	Min: 3 N/mm <sup>2</sup>	Min: 3 N/mm <sup>2</sup>	Min: 3 N/mm <sup>2</sup>	Min: 3 N/mm <sup>2</sup>	Min: 3 N/mm <sup>2</sup>	Min: 3 N/mm <sup>2</sup>	Min: 3 N/mm <sup>2</sup>	Min: 3 N/mm <sup>2</sup>
Flexibility	EN ISO 24344		No Crack	No Crack	No Crack	No Crack	No Crack	No Crack	No Crack	No Crack

In case, you otherwise specify, standard OtoKap Print products are produced with recycled PVC ingredients which the chemical history is not certified and is accepted as unknown. The chemical structure, ingredients, and chemical behaviors, including fire behavior, cannot be warranted

and are not declarable because of this recycled PVC content. However, is an optional variant and is produced with only virgin

raw material ingredients, and thus its chemical structure and chemical behaviors, including fire behavior, is totally declarable. Please kindly contact your supplier for further information.

\* Sipariş geçmeden önce, lütfen güncel TDS verilerini talep edin.

\* Before placing an order, please request up-to-date TDS data.

Recycled PVC Content	✓	✗
CE	✗	✓
Wear Group	Group T	Group T
Binder Content	Type 1	Type 1
Abrasion Resistance	✓	✓
100% Recyclable	✓	✓
Flexibility	✓	✓
Easy to Clean	✓	✓
Underfoot Comfort	✓	✓
Chemical Structure Declaration	✗	✓
Horizontal Burning Declaration	✗	✓
Burning Behavior Declaration	✗	✓
Price	\$	\$ \$

Printed Transport Floor Coverings

Araç İçi Baskılı Kaplamaları

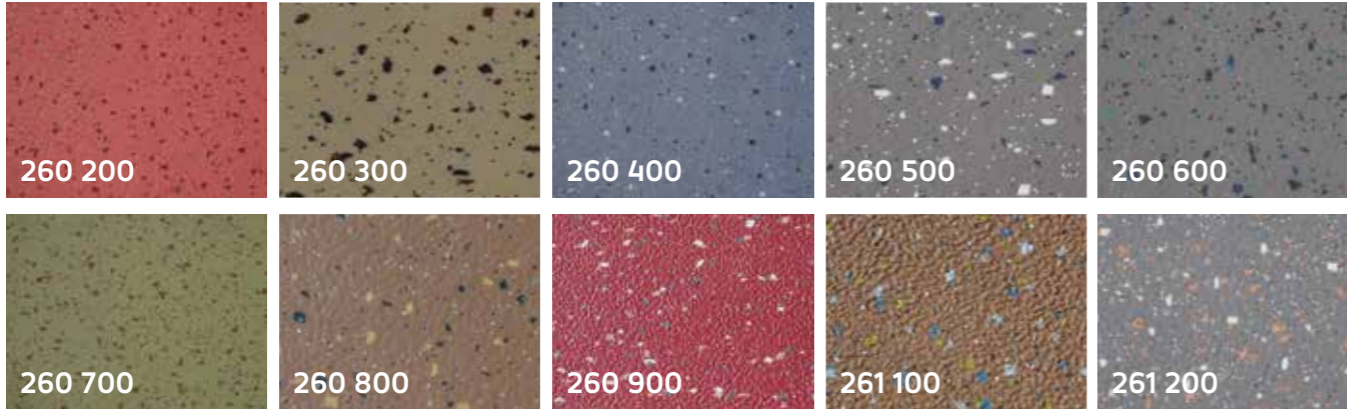
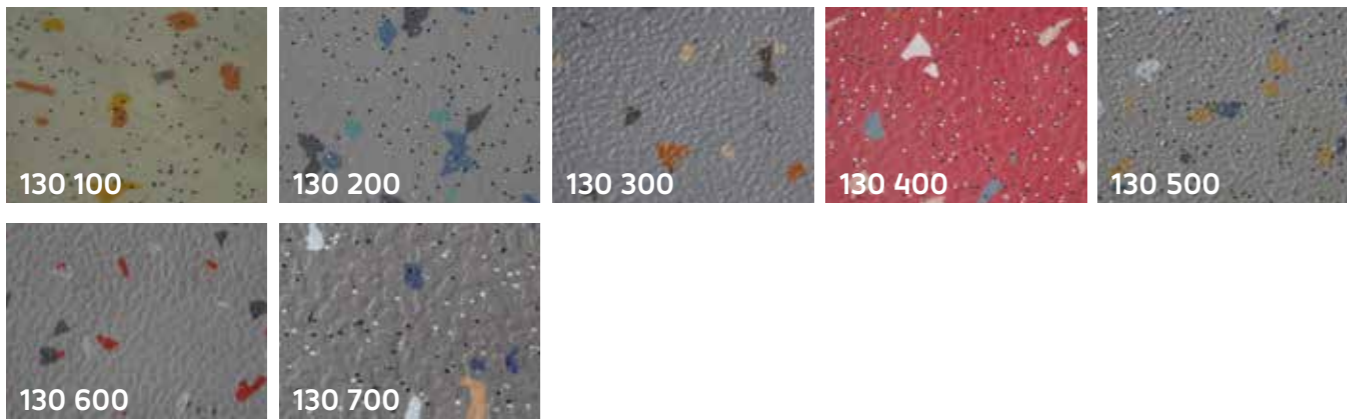
Автомобильные узорные  
напольные покрытия
**LEVEND ( 260 / 261 )**

**GALAKSI ( 130 )**

**TAPIS ( 470 )**



\*\* Real products may differ from above images. Please kindly note to ask for real products samples before confirming your order.

\*\* Gerçek ürünler yukarıdaki resimlerden farklı olabilir. Lütfen siparişinizi vermeden önce gerçek ürün numunelerini istemeyi unutmayın.

\*\* Реальные продукты могут отличаться от изображений выше. Пожалуйста, обратите внимание, чтобы запросить образцы реальной продукции перед подтверждением вашего заказа.

Printed Transport Floor Coverings

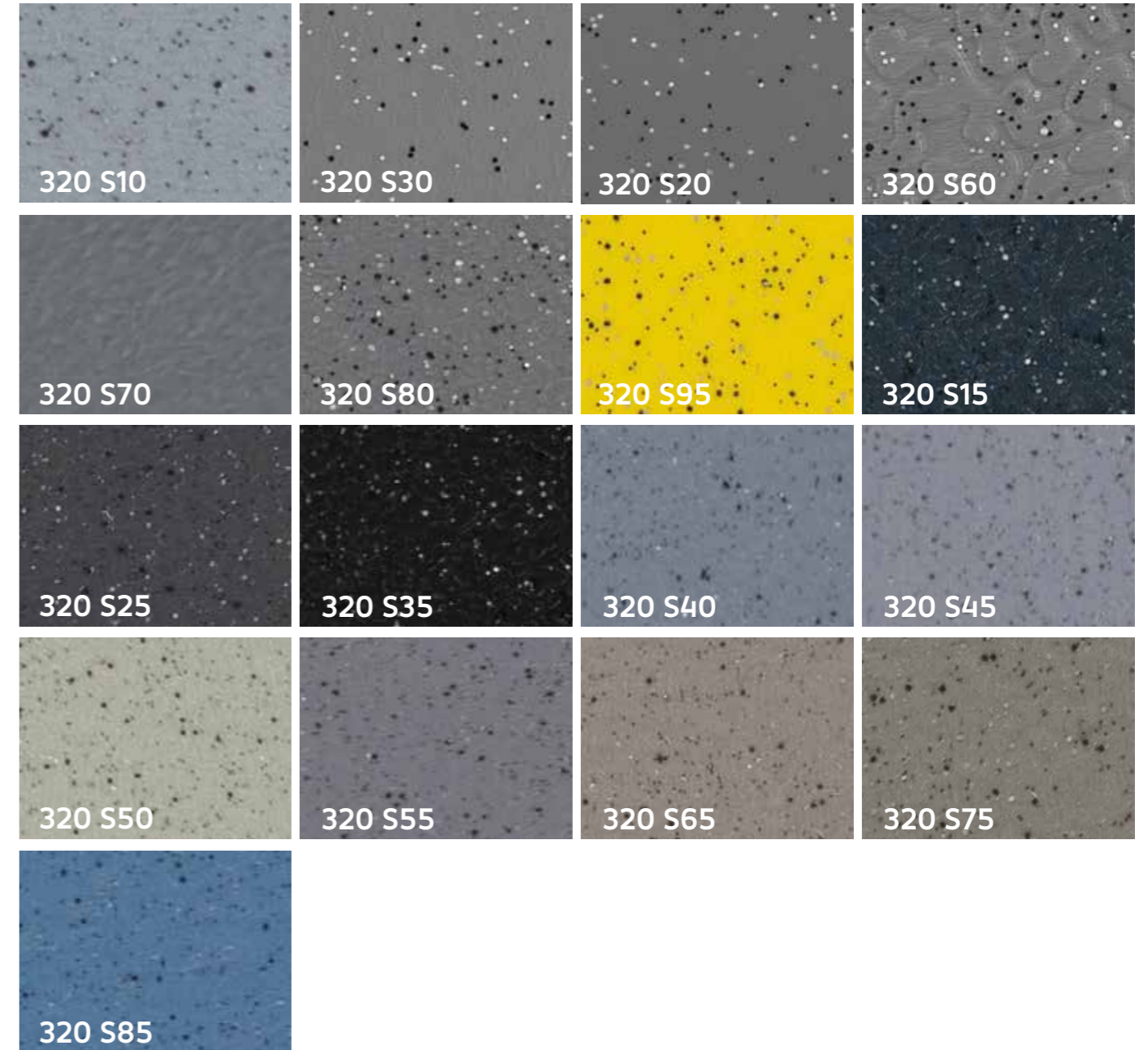
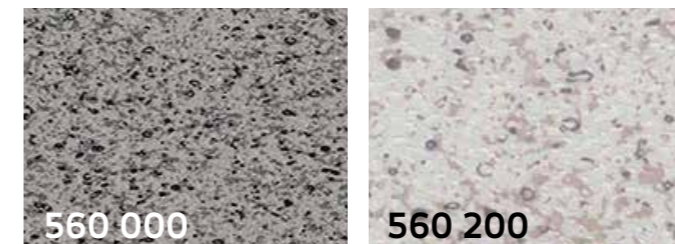
Araç İçi Baskılı Kaplamaları

Автомобильные узорные  
напольные покрытия
**SPARKLED ( 320 )**

**ASSOS ( 560 )**

**MERSO ( 250 )**

\*\* Real products may differ from above images. Please kindly note to ask for real products samples before confirming your order.

\*\* Gerçek ürünler yukarıdaki resimlerden farklı olabilir. Lütfen siparişinizi vermeden önce gerçek ürün numunelerini istemeyi unutmayın.

\*\* Реальные продукты могут отличаться от изображений выше. Пожалуйста, обратите внимание, чтобы запросить образцы реальной продукции перед подтверждением вашего заказа.



Floor Coverings For  
Portable Cabines

Seyyar Yaşam Alanları İçin  
Zemin Kaplaması

Портативные жилые помещения  
Напольные покрытия

# EcoPrint



100% Recyclable  
Floor Covering

%100 Geri Dönüşümlü  
Zemin Kaplaması

100% перерабатываемый  
Напольное покрытие

**net**  
FLOOR COVERINGS

[www.netfloor.com.tr](http://www.netfloor.com.tr)



## Portable Living Areas Floor Coverings



## Seyyar Yaşam Alanları İçin Zemin Kaplaması



## Портативные жилые помещения Напольные покрытия



- Economical TX045 supported floor covering for general-purpose and temporary living areas, which can be applied easily and quickly.

- It is in Group-T wear class. It is a Type-1 floor covering. With its calendared wear layer, it is resistant to traffic caused by dynamic loads.

- Can be installed in portable cabins and general-use areas.

- It is a 100% recyclable floor covering.

- It is environmentally friendly with its recycle-friendly structure.

- It contains environmentally friendly recycled raw materials.

- Being a recyclable material, it has no chemical content and no traceability.

- It is easy to clean and suitable for mop cleaning.

- Its special absorbent felt base Tx045 can be applied to all surfaces easily.

- Specially designed felt backing softens the textile effect on the product while still keeping its flexible and easy-to-install structure mainly originating from the very same textile.

- Genel amaçlı ve geçici yaşam sahalarına dönük, kolay ve hızlı uygulanabilen, ekonomik TX045 destekli zemin kaplaması.

- Grup-T aşınma sınıfındadır. Tip-1 zemin kaplamasıdır.

- Kalenderlenmiş aşınma tabakasıyla, dinamik yüklerden kaynaklı trafiğe karşı, mukavimdir.

- Genel kullanım alanları ve Seyyar yaşam alanları.

- %100 geri dönüşümlü bir zemin kaplamasıdır.

- Çevre dostu geri dönüşümlü hammadde içerir.

- Geri dönüşümlü bir malzeme olmasından dolayı, kimyasal içerik ve izlenebilirliği yoktur.

- Nemli temizliğe uygun kolay temizlenebilir.

- Özel emici keçe tabanı Tx045 farklı yüzeylere kolayca uygulanabilir.

- Özel olarak tasarlanmış keçe altlık, ürün üzerindeki tekstil etkisini yumuşatır ve aynı tekstilden oluşan esnek ve kurulumu kolay yapısını korur.

- Экономичное напольное покрытие с задней поверхностью TX045 предназначенное для общего назначения и временных жилых помещений, обладает преимуществом быстрой и легкой укладки.

- Принадлежит классу истирания группы "Т". Напольное покрытие типа 1. Благодаря своему каландрированному износостойкому слою покрытие устойчиво к движению, вызванному динамическими нагрузками.

- Помещения общего пользования и мобильные жилые помещения.

- Это на 100% перерабатываемое напольное покрытие.

- Содержит экологически чистое, перерабатываемое сырье.

- Поскольку это перерабатываемый материал, он не содержит химических веществ и не подлежит прослеживаемости.

- Легко чистится и подходит для очищения тряпкой.

- Подходит для применения на всех поверхностях благодаря специальной абсорбирующей войлочной основе Tx150s.

- Специально разработанная войлочная основа смягчает эффект текстиля на изделии, сохраняя при этом его гибкую и простую в установке структуру, в основном происходящую из того же текстиля.



## Layer Diagrams



## Katman Şemaları



## Диаграммы слоев

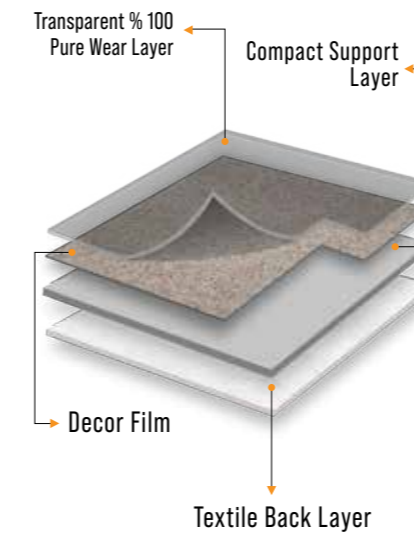

"Some products may use a different product architecture than the illustration above."

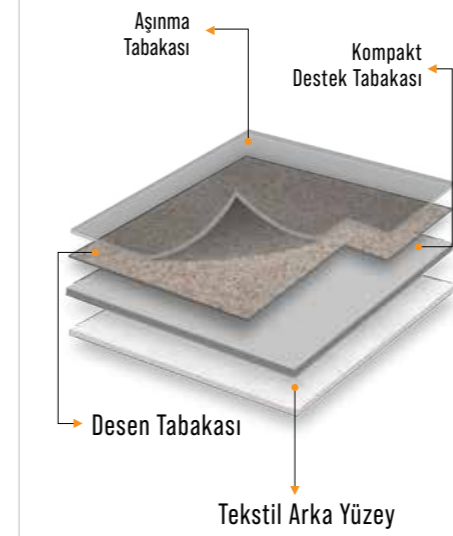

"Kimi ürünlerde, yukarıdaki gösterimden farklı ürün mimarisi kullanılabilir."







"Некоторые продукты могут использовать архитектуру продукта, отличную от той, что показана на рисунке выше."



## TECHNICAL DATA SHEET

## PRODUCT IDENTIFICATION : ECOPRINT

## TECHNICAL PROPERTIES

SPECIFICATION	STANDARD	PRODUCT		
 Total Thickness	EN ISO 24346	1.20 mm (min:-0.10 mm max: 0.13 mm)	1.40 mm (min:-0.10 mm max: 0.13 mm)	1.40 mm (min:-0.10 mm max: 0.13 mm)
 Wear Layer Thickness	EN ISO 24340	0.10 mm (max:+%13 min: -%10)	0.10 mm (max:+%13 min: -%10)	0.20 mm (max:+%13 min: -%10)
Total Weight	EN ISO 23997	1850 g/m <sup>2</sup> (max:+%13 min: -%10)	2125 g/m <sup>2</sup> (max:+%13 min: -%10)	2160 g/m <sup>2</sup> (max:+%13 min: -%10)
 Roll Width	EN ISO 24341	2 m	2 m	2 m
 Roll Length	EN ISO 24341	25 m	25 m	25 m
Back Layer		TX045	TX045	TX045
PERFORMANCE				
 Flexibility	EN ISO 24344	No Crack	No Crack	No Crack

In case, you otherwise specify, standard EcoPrint products are produced with recycled PVC ingredients which the chemical history is not certified and is accepted as unknown. The chemical structure, ingredients, and chemical behaviors, including fire behavior, cannot be warranted and are not

declarable because of this recycled PVC content. However,  is an optional variant and is produced with only virgin raw material

ingredients, and thus its chemical structure and chemical behaviors, including fire behavior, is totally declarable. Please kindly contact your supplier for further information.

\* Sipariş geçmeden önce, lütfen güncel TDS verilerini talep edin.

\* Before placing an order, please request up-to-date TDS data.

EcoPrint

  
EcoPrint

Recycled PVC Content	✓	✗
CE	✗	✓
Wear Group	Group T	Group T
Binder Content	Type 1	Type 1
Abrasion Resistance	✓	✓
100% Recyclable	✓	✓
Flexibility	✓	✓
Easy to Clean	✓	✓
Chemical Structure Declaration	✗	✓
Burning Behavior Declaration	✗	✓
Price	\$	\$ \$

Portable Living Areas  
Floor CoveringsSeyyar Yaşam Alanları İçin  
Zemin KaplamasıПортативные жилые помещения  
Напольные покрытия

## MYRA ( 670 / 671 )

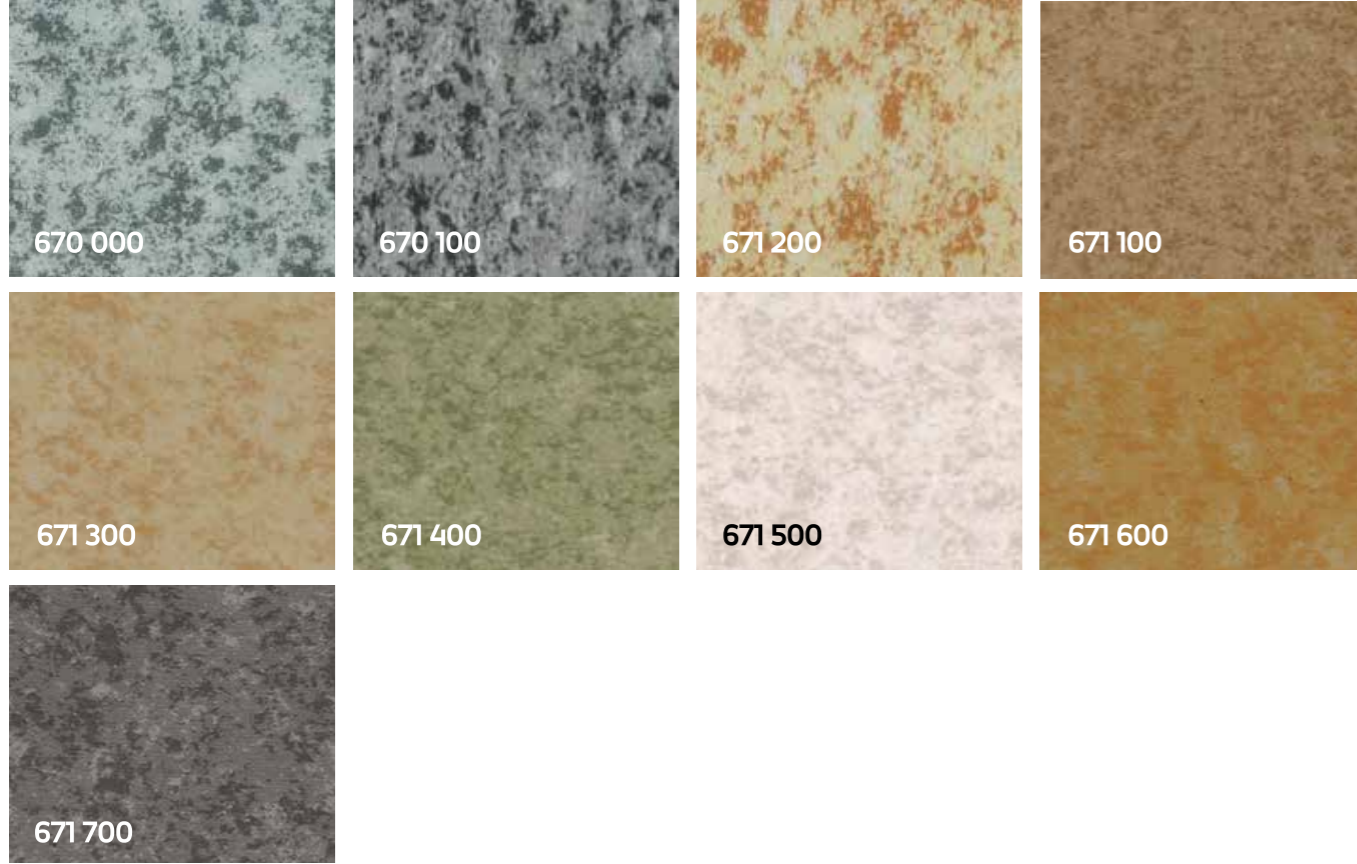

## WOODLINE ( 280 / 281 )

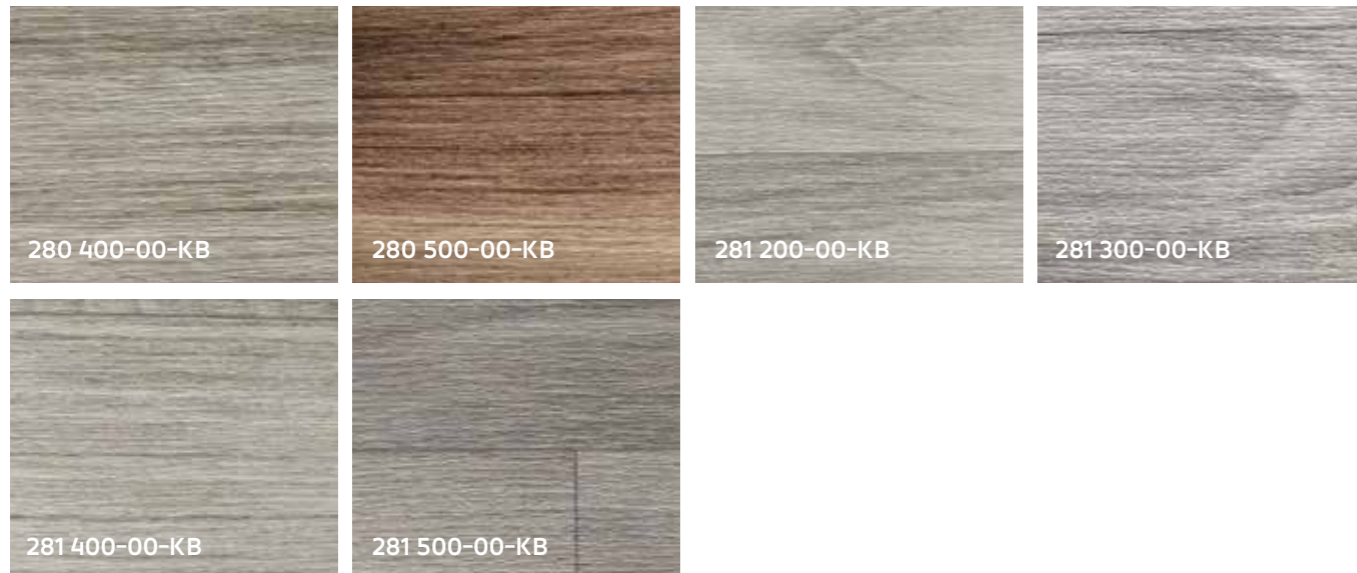

\*\* Real products may differ from above images. Please kindly note to ask for real products samples before confirming your order.

\*\* Gerçek ürünler yukarıdaki resimlerden farklı olabilir. Lütfen siparişinizi vermeden önce gerçek ürün numunelerini istemeyi unutmayın.

\*\* Реальные продукты могут отличаться от изображений выше. Пожалуйста, обратите внимание, чтобы запросить образцы реальной продукции перед подтверждением вашего заказа.

Portable Living Areas  
Floor CoveringsSeyyar Yaşam Alanları İçin  
Zemin KaplamasıПортативные жилые помещения  
Напольные покрытия

## DÜZ RENKLER

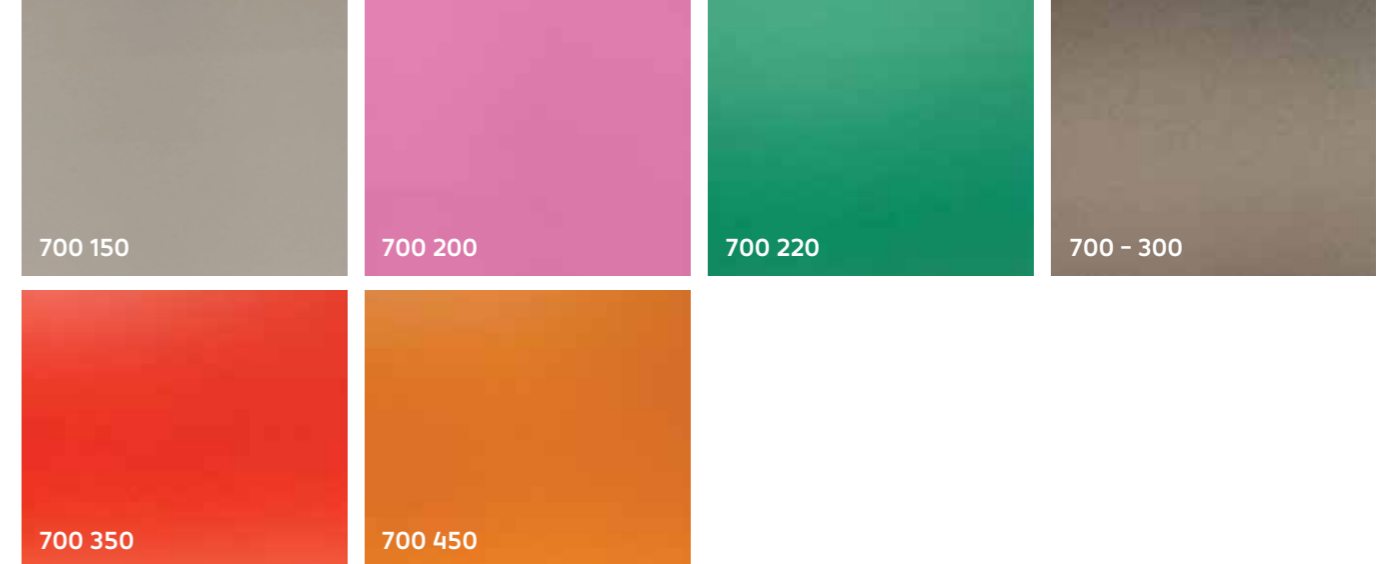

\*\* Real products may differ from above images. Please kindly note to ask for real products samples before confirming your order.

\*\* Gerçek ürünler yukarıdaki resimlerden farklı olabilir. Lütfen siparişinizi vermeden önce gerçek ürün numunelerini istemeyi unutmayın.

\*\* Реальные продукты могут отличаться от изображений выше. Пожалуйста, обратите внимание, чтобы запросить образцы реальной продукции перед подтверждением вашего заказа.

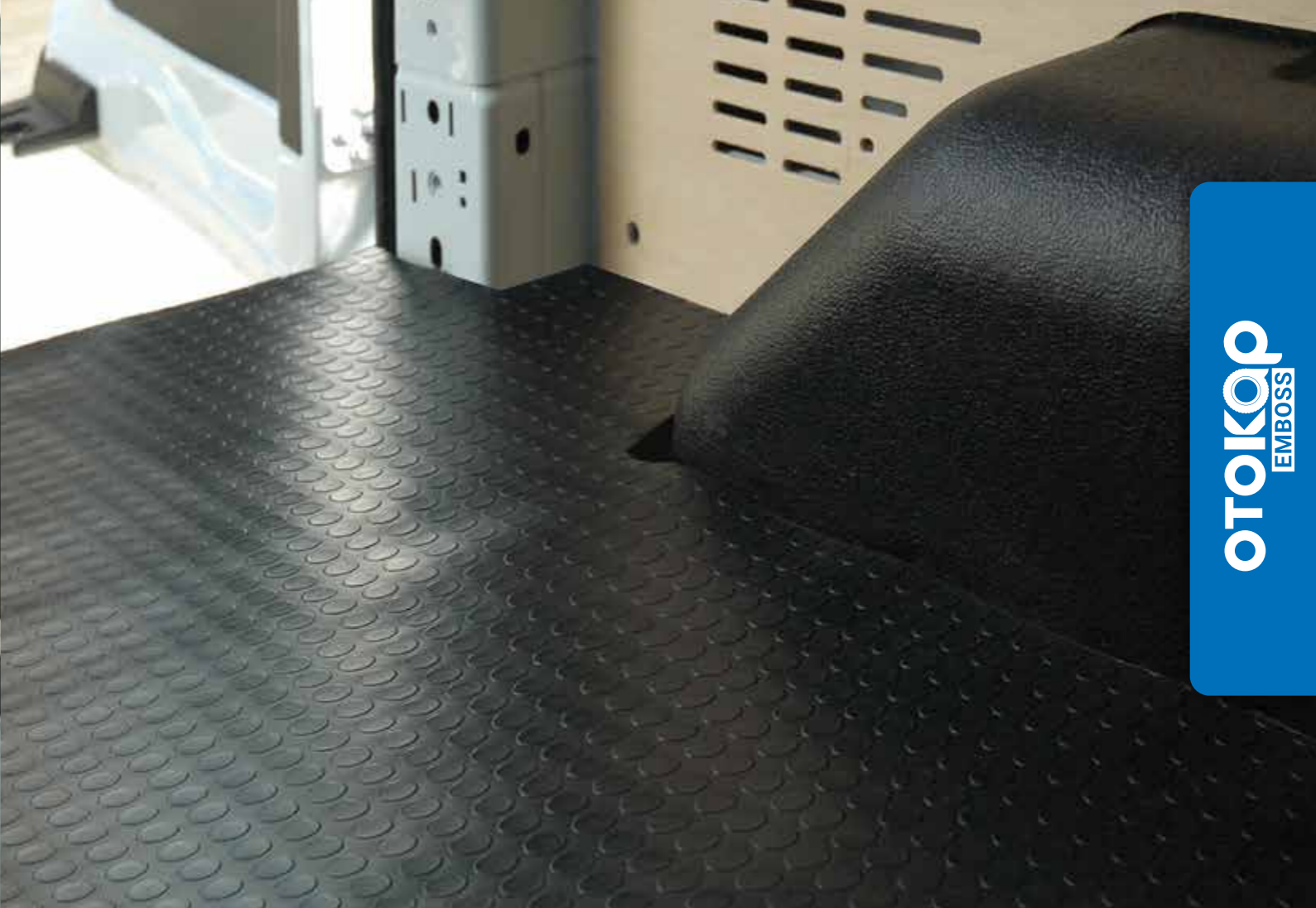

OTOKAP  
EMBOSS

Transport  
Floor Coverings

Araç İçi  
Zemin Kaplamaları

Автомобильные  
Напольные Покрытия

OTOKAP  
EMBOSS



net  
FLOOR COVERINGS

[www.netfloor.com.tr](http://www.netfloor.com.tr)



## Transport Floor Coverings



## Araç İçi Zemin Kaplamaları



## Автомобильные Покрытия



- Has been produced for car upholstery sector.
- Is able to hold stitch with its flexible structure.
- Can easily stick on different types of surfaces thanks to TX150.
- Is remarkable with its 3 dimensioned surface.
- Can also be used as covering and mat.
- Can be manufactured in special dimensions in order to reduce material and labor scrap.
- Otokap - Emboss is completely environment friendly and 100% recyclable.
- Is more durable than foam based equivalents thanks to its compressed compact structure.
- Can be produced as anti-bacterial if required.

- Oto döşeme sektörü için üretilmiştir.
- Esnek yapısı ile dikiş tutabilir.
- TX150 sayesinde farklı yüzeylere kolayca yapışabilir.
- 3 boyutlu yüzeyi ile dikkat çekicidir.
- Kılıf ve paspas olarak da kullanılabilir.
- Malzeme ve işçilik firesini azaltmak için özel ölçülerde de üretilir.
- Otokap-Emboss tamamen çevre dostudur ve %100 geri dönüşümlüdür.
- Sıkıştırılmış kompakt yapısı sayesinde köpük tabanlı muadillerinden daha mukavimdir.
- İstendiğinde anti-bakteriyel olarak da üretilir.

- Изготовлен для сектора автомобильных покрытий.
- Гибкая структура позволяет прошивать материал.
- TX150 обеспечивает легкое склеивание с любыми поверхностями.
- Привлекает внимание 3-х мерной поверхностью.
- Может использоваться в качестве чехла и половика.
- Может изготавливаться в специальных размерах для снижения излишних затрат материалов и трудозатрат.
- Otokap-Emboss является экологически чистым и 100% утилизируемым.
- Благодаря сжатой компактной структуре более устойчивый по сравнению со своими аналогами с пенопластовым основанием.
- По желанию может изготавливаться антибактериальным.



## Layer Diagrams



## Katman Şemaları



## Диаграммы слоев

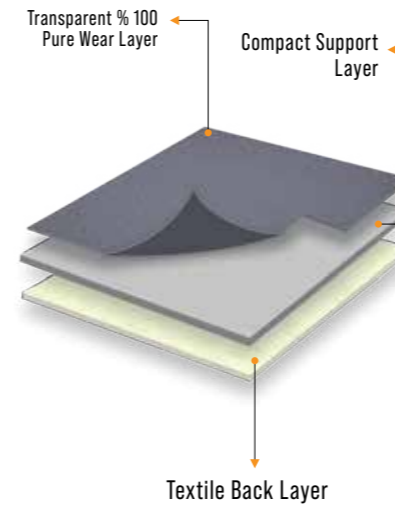

"Some products may use a different product architecture than the illustration above."

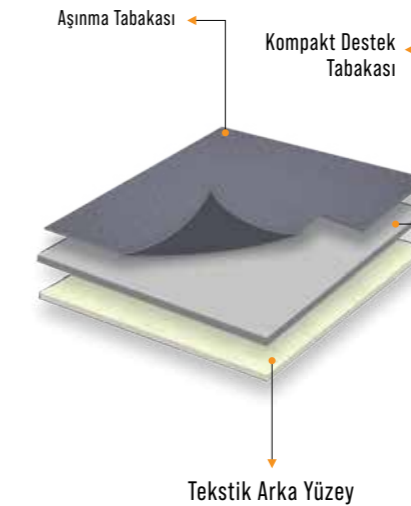

"Kimi ürünlerde, yukarıdaki gösterimden farklı ürün mimarisi kullanılabilir."

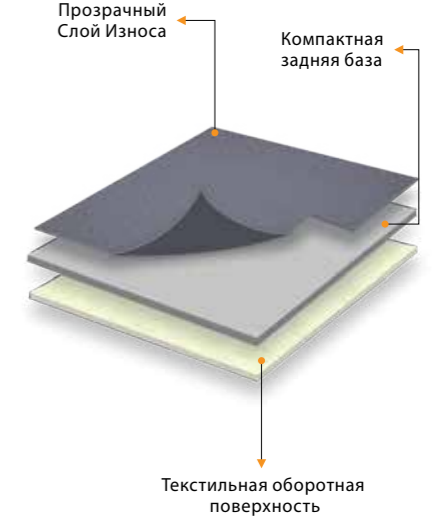

"Некоторые продукты могут использовать архитектуру продукта, отличную от той, что показана на рисунке выше."



GLASS FIBER TISSUE/CAM ELYAF : NO

## TECHNICAL DATA SHEET

PRODUCT IDENTIFICATION : OTOKAP EMOSS

## TECHNICAL PROPERTIES

DESCRIPTION	STANDARD	UNIT	PRODUCT					
Back Layer			TX100	TX150	TX150	TX150	TX150	TX150
Total Thickness	EN ISO 24346	mm	1.20	1.40	1.60	1.80	2	2,2
Wear Layer Thickness	EN ISO 24340	mm	0.10	0.10	0.10	0.10	0.10	0.10
Unit Area Mass	EN ISO 23997	g/m <sup>2</sup>	1260	1605	1910	2280	2570	2850
Roll Width	EN ISO 24341	m	2	2	2	2	2	2
Roll Length	EN ISO 24341	m	18	18	18	18	18	18
PERFORMANCE								
Dimensional Stability	EN ISO 23999	%	≤%0.4	≤%0.4	≤%0.4	≤%0.4	≤%0.4	≤%0.4
Curling	EN ISO 23999	mm	max:8	max:8	max:8	max:8	max:8	max:8
Tensile Strength Crosswise	EN ISO 527	N/mm <sup>2</sup>	Min: 3 N/mm <sup>2</sup>	Min: 3 N/mm <sup>2</sup>	Min: 3 N/mm <sup>2</sup>	Min: 3 N/mm <sup>2</sup>	Min: 3 N/mm <sup>2</sup>	Min: 3 N/mm <sup>2</sup>
Tensile Strength Lengthwise	EN ISO 527	N/mm <sup>2</sup>	Min: 3 N/mm <sup>2</sup>	Min: 3 N/mm <sup>2</sup>	Min: 3 N/mm <sup>2</sup>	Min: 3 N/mm <sup>2</sup>	Min: 3 N/mm <sup>2</sup>	Min: 3 N/mm <sup>2</sup>
Flexibility	EN ISO 24344		No Crack	No Crack	No Crack	No Crack	No Crack	No Crack

In case, you otherwise specify, standard OtoKap Emboss products are produced with recycled PVC ingredients which the chemical history is not certified and is accepted as unknown. The chemical structure, ingredients, and chemical behaviors, including fire behavior, cannot be warranted

and are not declarable because of this recycled PVC content. However, is an optional variant and is produced with only virgin raw material ingredients, and thus its chemical structure and chemical behaviors, including fire behavior, is totally declarable. Please kindly contact your supplier for further information.

\* Sipariş geçmeden önce, lütfen güncel TDS verilerini talep edin.

\* Before placing an order, please request up-to-date TDS data.



Recycled PVC Content	✓	✗
CE	✗	✓
Wear Group	Group T	Group T
Binder Content	Type 1	Type 1
Abrasion Resistance	✓	✓
100% Recyclable	✓	✓
Flexibility	✓	✓
Easy to Clean	✓	✓
Underfoot Comfort	✓	✓
Chemical Structure Declaration	✗	✓
Horizontal Burning Declaration	✗	✓
Burning Behavior Declaration	✗	✓
Price	\$	\$ \$

Transport Floor Coverings

Araç İçi Zemin Kaplamaları

Автомобильные  
Напольные покрытия

## MEGA ( 400 )



## PARA ( 105 )



\*\* Real products may differ from above images. Please kindly note to ask for real products samples before confirming your order.

\*\* Gerçek ürünler yukarıdaki resimlerden farklı olabilir. Lütfen siparişinizi vermeden önce gerçek ürün numunelerini istemeyi unutmayın.

\*\* Реальные продукты могут отличаться от изображений выше. Пожалуйста, обратите внимание, чтобы запросить образцы реальной продукции перед подтверждением вашего заказа.

Transport Floor Coverings

Araç İçi Zemin Kaplamaları

Автомобильные  
Напольные покрытия

## ORTA PARALI ( 310 )



## TRANSİT ( 155 )



\*\* Real products may differ from above images. Please kindly note to ask for real products samples before confirming your order.

\*\* Gerçek ürünler yukarıdaki resimlerden farklı olabilir. Lütfen siparişinizi vermeden önce gerçek ürün numunelerini istemeyi unutmayın.

\*\* Реальные продукты могут отличаться от изображений выше. Пожалуйста, обратите внимание, чтобы запросить образцы реальной продукции перед подтверждением вашего заказа.

Transport Floor Coverings

Araç İçi Zemin Kaplamaları

Автомобильные  
Напольные покрытия

## PETEK ( 205 )

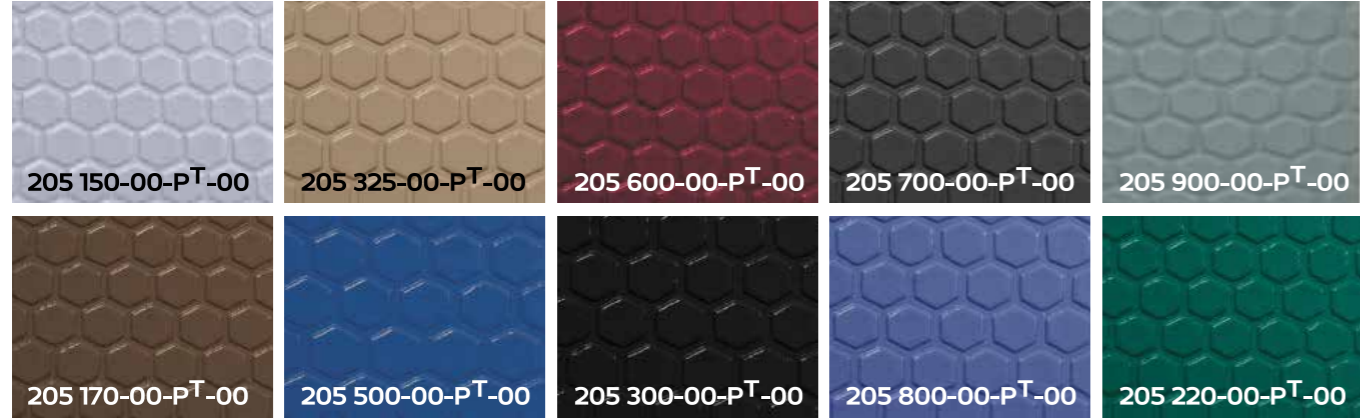

## DAMA ( 800 )



## PORTER ( 900 )

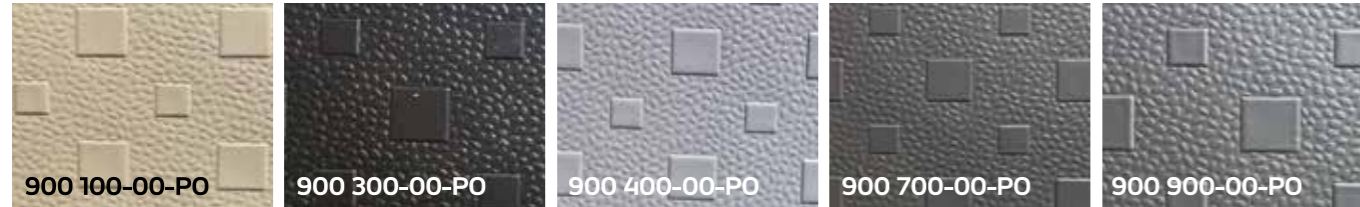

\*\* Real products may differ from above images. Please kindly note to ask for real products samples before confirming your order.

\*\* Gerçek ürünler yukarıdaki resimlerden farklı olabilir. Lütfen siparişinizi vermeden önce gerçek ürün numunelerini istemeyi unutmayın.

\*\* Реальные продукты могут отличаться от изображений выше. Пожалуйста, обратите внимание, чтобы запросить образцы реальной продукции перед подтверждением вашего заказа.

Transport Floor Coverings

Araç İçi Zemin Kaplamaları

Автомобильные  
Напольные покрытия

## AĞAÇ ( 590 )

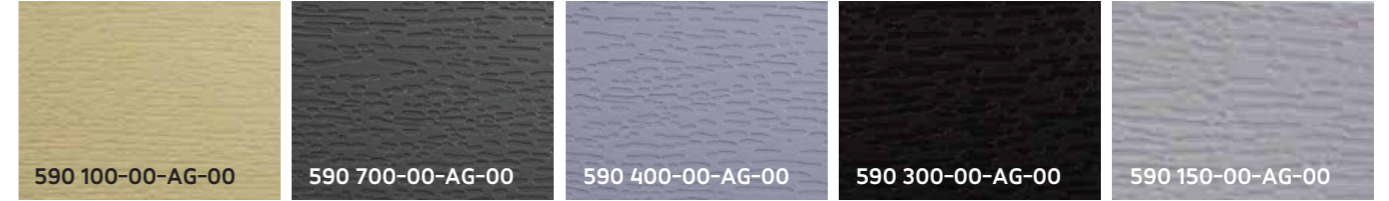

## ZİNCİR ( 600 )



\*\* Real products may differ from above images. Please kindly note to ask for real products samples before confirming your order.

\*\* Gerçek ürünler yukarıdaki resimlerden farklı olabilir. Lütfen siparişinizi vermeden önce gerçek ürün numunelerini istemeyi unutmayın.

\*\* Реальные продукты могут отличаться от изображений выше. Пожалуйста, обратите внимание, чтобы запросить образцы реальной продукции перед подтверждением вашего заказа.

Transport Floor Coverings

Araç İçi Zemin Kaplamaları

Автомобильные  
Напольные покрытия

## LINEAR ( 550 )

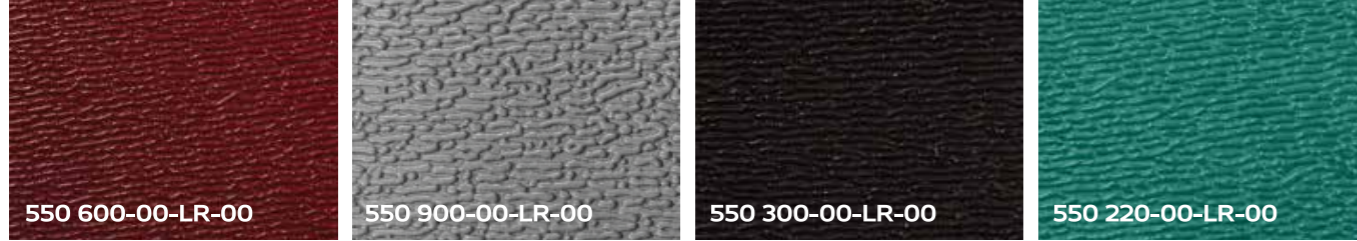

## CRAFT ( 450 )



## PORTO ( 620 )

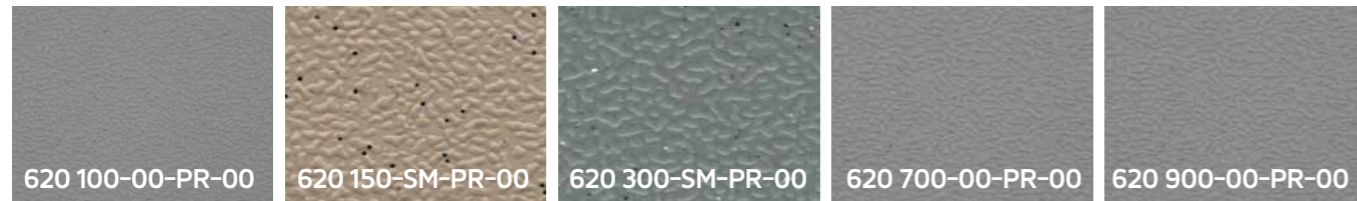

\*\* Real products may differ from above images. Please kindly note to ask for real products samples before confirming your order.

\*\* Gerçek ürünler yukarıdaki resimlerden farklı olabilir. Lütfen siparişinizi vermeden önce gerçek ürün numunelerini istemeyi unutmayın.

\*\* Реальные продукты могут отличаться от изображений выше. Пожалуйста, обратите внимание, чтобы запросить образцы реальной продукции перед подтверждением вашего заказа.

Transport Floor Coverings

Araç İçi Zemin Kaplamaları

Автомобильные  
Напольные покрытия

## HEELPAD ( 700 )



\*\* Real products may differ from above images. Please kindly note to ask for real products samples before confirming your order.

\*\* Gerçek ürünler yukarıdaki resimlerden farklı olabilir. Lütfen siparişinizi vermeden önce gerçek ürün numunelerini istemeyi unutmayın.

\*\* Реальные продукты могут отличаться от изображений выше. Пожалуйста, обратите внимание, чтобы запросить образцы реальной продукции перед подтверждением вашего заказа.



**OTOKAP**  
EXTRA SOFT

Transport  
Floor Coverings

Araç İçi  
Zemin Kaplamaları

Автомобильные  
Напольные Покрытия

**OTOKAP**  
EXTRA SOFT

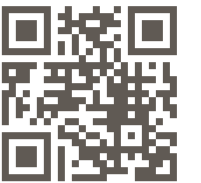

**net**  
FLOOR COVERINGS

[www.netfloor.com.tr](http://www.netfloor.com.tr)



## Transport Floor Coverings



## Araç İçi Zemin Kaplamaları



## Автомобильные HanonbHble noKpblTI/ИH



- Has been produced for car upholstery sector.
  - Can be easily processed under cold climates with its ultra softened structure.
  - Designed especially for winter months and cold climates.
  - Has extra flexibility that is suitable for stitching for those who are extra sensitive in their work.
  - Is ideal to protect vehicles' carpet floors with its easily-curling structure.
- Our colors in color palette,**
- Can be applied in all OTOKAP and YERKAP products.
  - Our standard colors are 150, 300, 400, 700, 900.
  - Please ask for the minimum order quantity for special colors presented in color palette.
  - Can be manufactured in RAL codes if preferred.

- Oto döşeme sektörü için üretilmiştir.
  - Ultra yumuşatılmış yapısıyla soğuk iklimlerde de kolayca işlenebilir.
  - Özellikle kış ayları ve soğuk coğrafyalar için üretilmiştir.
  - İşlerinde ekstra hassas olanlar için dikişe uygun ekstra esnekliğe sahiptir.
  - Kolayca kıvrılan yapısı ile araçların halı tabanını korumak için idealdir.
- Renk kartelasındaki renklerimiz,**
- Tüm OTOKAP ve YERKAP ürünlerinde uygulanabilir.
  - Standart renklerimiz 150, 300, 400, 700, 900 dür.
  - Renk Kartelasından seçtiğiniz özel renklerimiz için minimum sipariş miktarlarını sorunuz.
  - İstenildiğinde RAL kodları ile de üretimi yapılabilir.

- Изготовлены для сектора автомобильных покрытий.
  - Ультра мягкая структура позволяет также легко применять их в холодных климатических условиях.
  - Изготовлены особенно для зимних месяцев и холодных климатических зон.
  - Обладает экстремальной гибкостью, позволяющей прошивать их для экстремально точных работ.
  - Являются идеальными для защиты ковровых оснований благодаря легко сгибаемому структурам.
- Цвета нашей палитры,**
- Могут применяться во всех изделиях Otokap и YERKAP.
  - Наши стандартные цвета 150, 300, 400, 700, 900.
  - Для специальных цветов, выбранных из нашей цветовой палитры, уточните минимальное количество для заказа.
  - При необходимости производство осуществляется по кодам RAL.



## Layer Diagrams



## Katman Şemaları



## Диаграммы слоев

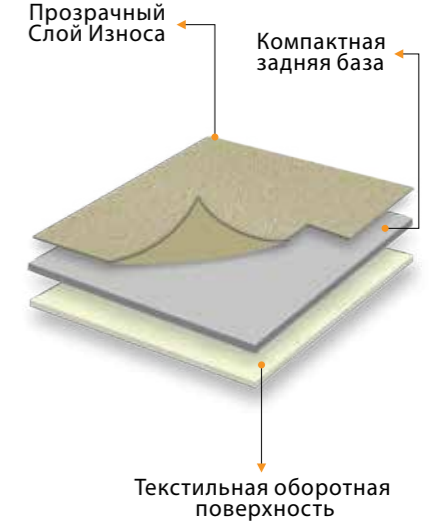
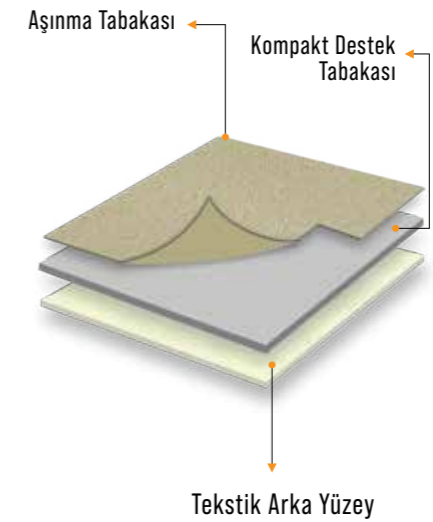
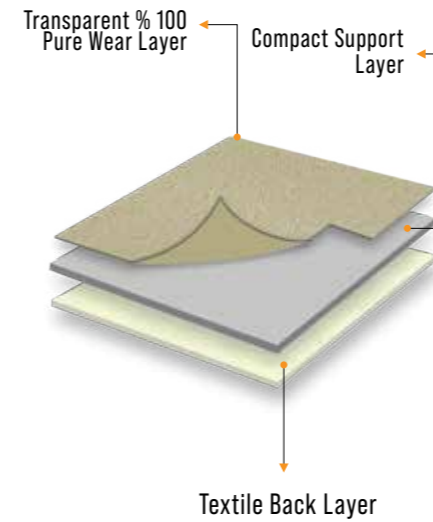

GLASS FIBER TISSUE : NO  
PURGUARD : NO

### TECHNICAL DATA SHEET

#### PRODUCT IDENTIFICATION : OTOKAP EKSTRA SOFT

#### TECHNICAL PROPERTIES

DESCRIPTION	STANDARD	UNIT			
Back Layer			TX150	TX150	TX150
Total Thickness	EN ISO 24346	mm	1.60	1.80	2
Wear Layer Thickness	EN ISO 24340	mm	0.10	0.10	0.10
Unit Area Mass	EN ISO 23997	g/m <sup>2</sup>	2050	2540	2825
Hardness	DIN 53505	ShA	70-75	70-75	70-75
Roll Width	EN ISO 24341	m	2	2	2
Roll Length	EN ISO 24341	m	18	18	18
PERFORMANCE					
Dimensional Stability	EN ISO 23999	%	≤%0.4	≤%0.4	≤%0.4
Curling	EN ISO 23999	mm	max:8	max:8	max:8
Tensile Strength Crosswise	EN ISO 527	N/mm <sup>2</sup>	Min: 3 N/mm <sup>2</sup>	Min: 3 N/mm <sup>2</sup>	Min: 3 N/mm <sup>2</sup>
Tensile strength Lengthwise	EN ISO 527	N/mm <sup>2</sup>	Min: 3 N/mm <sup>2</sup>	Min: 3 N/mm <sup>2</sup>	Min: 3 N/mm <sup>2</sup>
Flexibility	EN ISO 24344		No Crack	No Crack	No Crack

In case, you otherwise specify, standard Otokap Extra Soft products are produced with recycled PVC ingredients which the chemical history is not certified and is accepted as unknown. The chemical structure, ingredients, and chemical behaviors, including fire behavior, cannot be

warranted and are not declarable because of this recycled PVC content. However, is an optional variant and is produced with only

virgin raw material ingredients, and thus its chemical structure and chemical behaviors, including fire behavior, is totally declarable. Please kindly contact your supplier for further information.

\* Sipariş geçmeden önce, lütfen güncel TDS verilerini talep edin.

\* Before placing an order, please request up-to-date TDS data.

Recycled PVC Content	✓	✗
CE	✗	✓
Wear Group	Group T	Group T
Binder Content	Type 1	Type 1
Abrasion Resistance	✓	✓
100% Recyclable	✓	✓
Flexibility	✓	✓
Easy to Clean	✓	✓
Underfoot Comfort	✓	✓
Chemical Structure Declaration	✗	✓
Horizontal Burning Declaration	✗	✓
Burning Behavior Declaration	✗	✓
Price	\$	\$ \$

Transport Floor Coverings

Araç İçi Zemin Kaplamaları

Автомобильные  
Напольные покрытия

## MEGA ( 400 )



## PARA ( 105 )



\*\* Real products may differ from above images. Please kindly note to ask for real products samples before confirming your order.

\*\* Gerçek ürünler yukarıdaki resimlerden farklı olabilir. Lütfen siparişinizi vermeden önce gerçek ürün numunelerini istemeyi unutmayın.

\*\* Реальные продукты могут отличаться от изображений выше. Пожалуйста, обратите внимание, чтобы запросить образцы реальной продукции перед подтверждением вашего заказа.

Transport Floor Coverings

Araç İçi Zemin Kaplamaları

Автомобильные  
Напольные покрытия

## TRANSİT ( 155 )



\*\* Real products may differ from above images. Please kindly note to ask for real products samples before confirming your order.

\*\* Gerçek ürünler yukarıdaki resimlerden farklı olabilir. Lütfen siparişinizi vermeden önce gerçek ürün numunelerini istemeyi unutmayın.

\*\* Реальные продукты могут отличаться от изображений выше. Пожалуйста, обратите внимание, чтобы запросить образцы реальной продукции перед подтверждением вашего заказа.

Transport Floor Coverings

Araç İçi Zemin Kaplamaları

Автомобильные  
Напольные покрытия

## ORTA PARALI (310)



## PETEK (205)



\*\* Real products may differ from above images. Please kindly note to ask for real products samples before confirming your order.

\*\* Gerçek ürünler yukarıdaki resimlerden farklı olabilir. Lütfen siparişinizi vermeden önce gerçek ürün numunelerini istemeyi unutmayın.

\*\* Реальные продукты могут отличаться от изображений выше. Пожалуйста, обратите внимание, чтобы запросить образцы реальной продукции перед подтверждением вашего заказа.

Transport Floor Coverings

Araç İçi Zemin Kaplamaları

Автомобильные  
Напольные покрытия

## DAMA (800)



## PORTER (900)

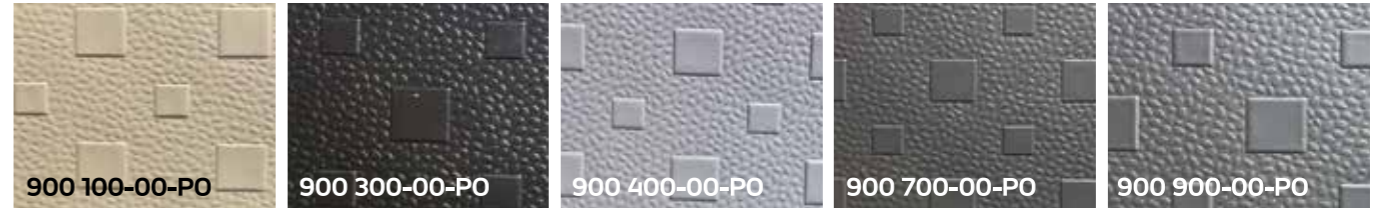

## AĞAÇ (590)

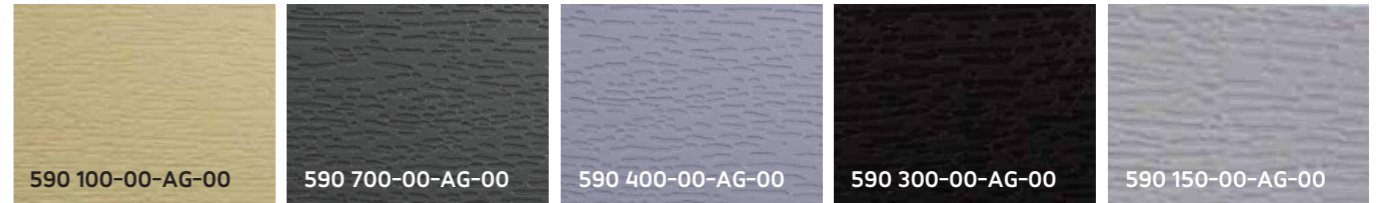

## LINEAR (550)

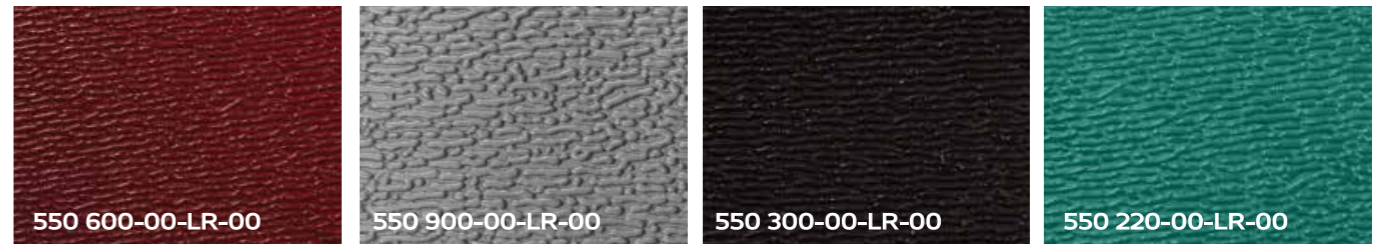

\*\* Real products may differ from above images. Please kindly note to ask for real products samples before confirming your order.

\*\* Gerçek ürünler yukarıdaki resimlerden farklı olabilir. Lütfen siparişinizi vermeden önce gerçek ürün numunelerini istemeyi unutmayın.

\*\* Реальные продукты могут отличаться от изображений выше. Пожалуйста, обратите внимание, чтобы запросить образцы реальной продукции перед подтверждением вашего заказа.

Transport Floor Coverings

Araç İçi Zemin Kaplamaları

Автомобильные  
Напольные покрытия

## ZİNCİR ( 600 )



## CRAFT ( 450 )

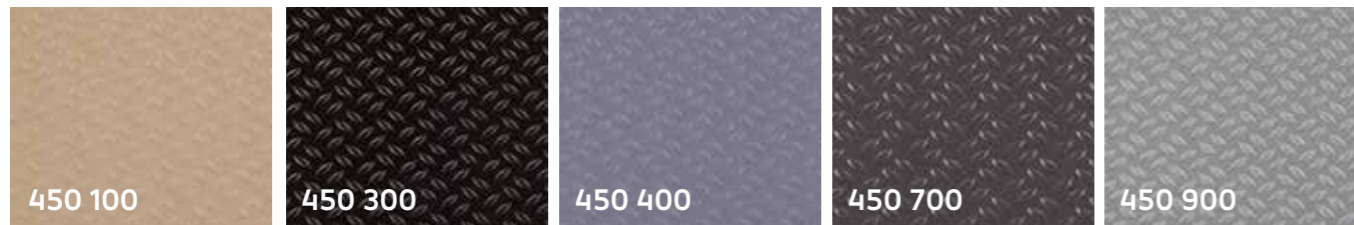

## PORTO ( 620 )

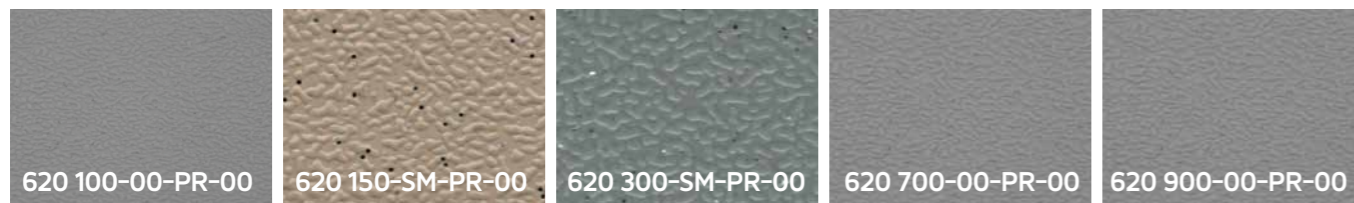

\*\* Real products may differ from above images. Please kindly note to ask for real products samples before confirming your order.

\*\* Gerçek ürünler yukarıdaki resimlerden farklı olabilir. Lütfen siparişinizi vermeden önce gerçek ürün numunelerini istemeyi unutmayın.

\*\* Реальные продукты могут отличаться от изображений выше. Пожалуйста, обратите внимание, чтобы запросить образцы реальной продукции перед подтверждением вашего заказа.

Transport Floor Coverings

Araç İçi Zemin Kaplamaları

Автомобильные  
Напольные покрытия

## HEELPAD ( 700 )



\*\* Real products may differ from above images. Please kindly note to ask for real products samples before confirming your order.

\*\* Gerçek ürünler yukarıdaki resimlerden farklı olabilir. Lütfen siparişinizi vermeden önce gerçek ürün numunelerini istemeyi unutmayın.

\*\* Реальные продукты могут отличаться от изображений выше. Пожалуйста, обратите внимание, чтобы запросить образцы реальной продукции перед подтверждением вашего заказа.

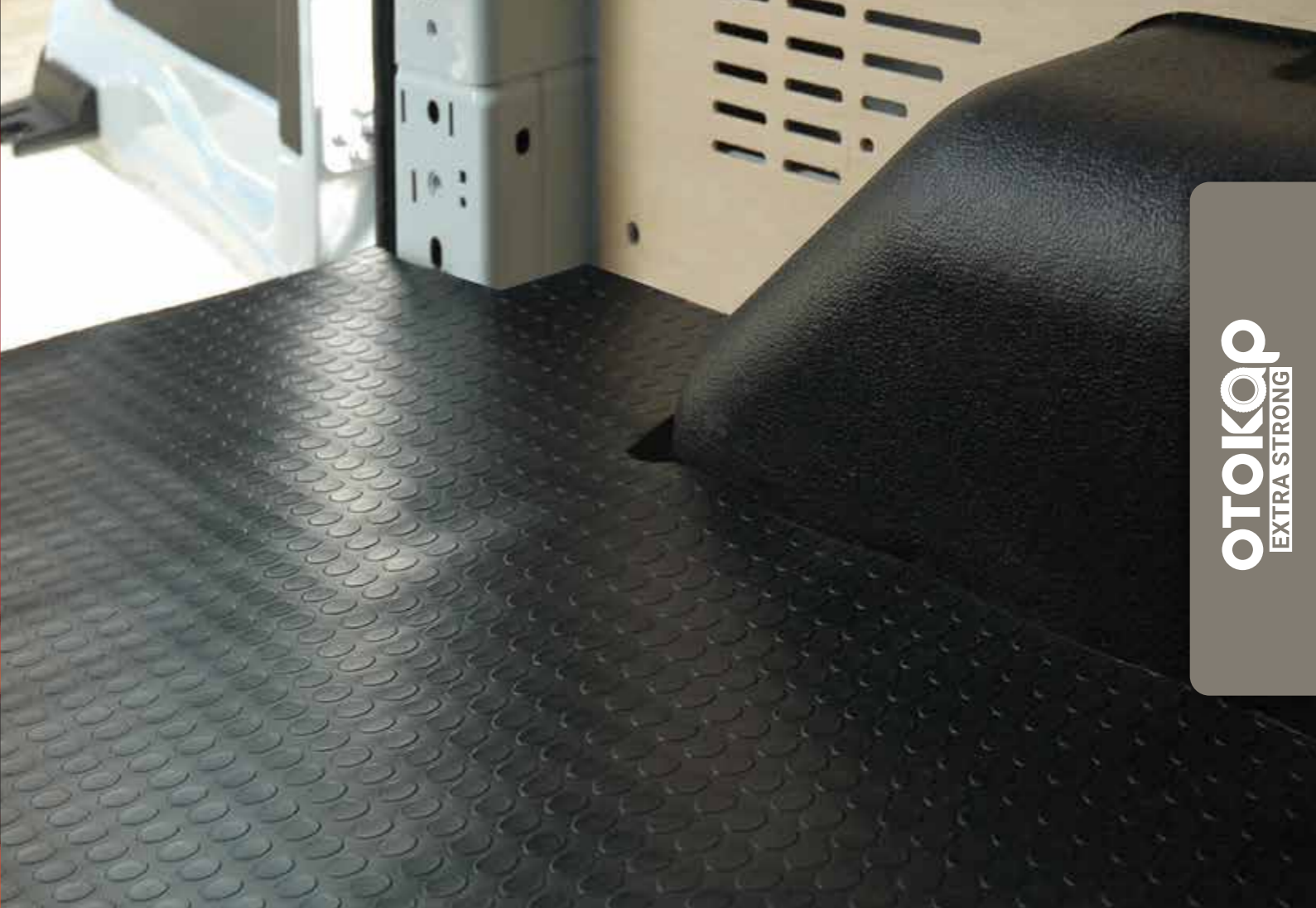

**OTOKAP**  
EXTRA STRONG

Transport  
Floor Coverings

Araç İçi  
Zemin Kaplamaları

Автомобильные  
Напольные покрытия

**OTOKAP**  
EXTRA STRONG



**net**  
FLOOR COVERINGS

[www.netfloor.com.tr](http://www.netfloor.com.tr)

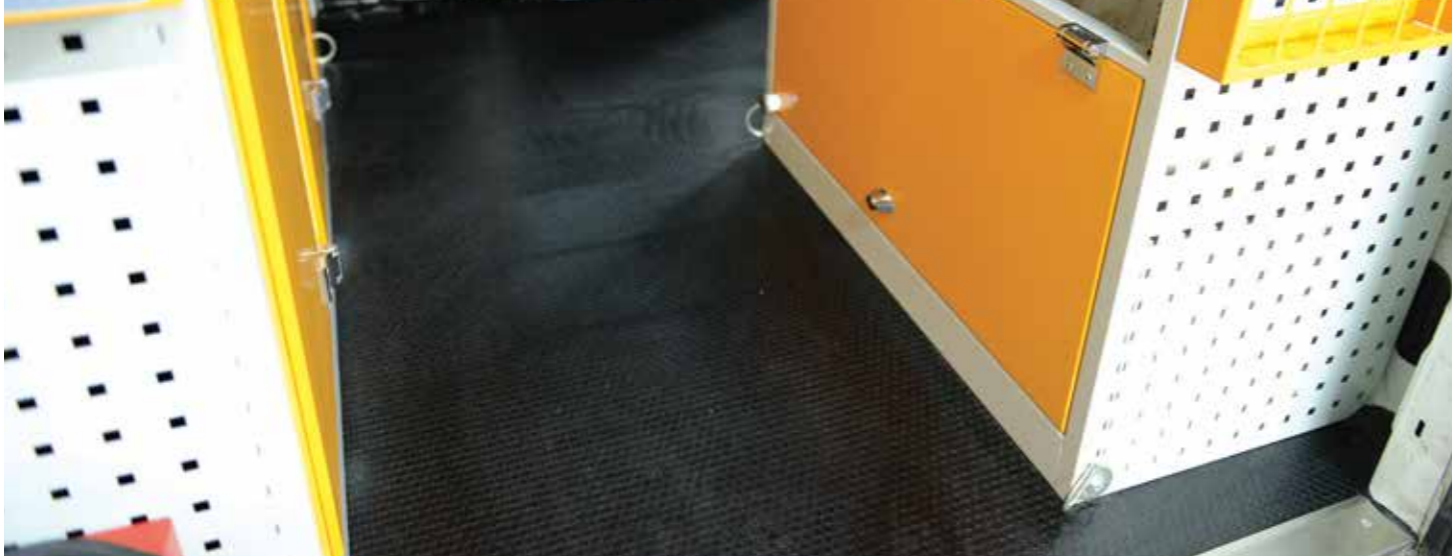

## Transport Floor Coverings



## Araç İçi Zemin Kaplamaları



## Автомобильные HanonbHble noKpblTI/ИH



- Reinforced Transport Floor Covering and General-Purpose Floor Covering
- Thanks to its flexible structure, reinforced wear layer and product architecture, it is convenient to use not only in vehicle cabins but also in general-purpose, domestic, and light commercial areas.
- Depending on its reinforced wear resistance, it is a long-lasting, T-class, Type-1 floor covering.
- Thanks to its special textile support layer OTX150, it contributes to sound and heat insulation of the room.
- Convenient for specially van & minibus cabins & commercial vehicles and also for areas under light traffic.
- It is a 100% environmentally friendly and recyclable floor covering.
- Standard version contains recycled raw materials.
- Standard version's chemical structure is not traceable due to its recycled content.
- Virgin structure is optional.
- Thanks to its specially reinforced surface, it can easily be cleaned.
- It can be easily installed on various surfaces thanks to its absorbent felt backing: OTX150 and flexible product structure.

### Dimensions:

Packing: Roll  
Width: 200 cm  
Roll Length: 10 - 18 Linear Meter  
Back Surface: OTX150  
Thickness: 1.8 and 2.00 mm

- Güçlendirilmiş Oto Döşeme ve Genel Amaçlı Zemin Kaplaması
- Esnek yapısı, güçlendirilmiş aşınma tabakası ve ürün mimarisiyle sadece araç kabinlerinde değil, genel amaçlı, evsel ve hafif ticari alanlarda kullanım için de uygundur.
- Güçlendirilmiş aşınma mukavemeti sayesinde uzun ömürlü, T-sınıfı, Tip-1 bir zemin kaplamasıdır.
- OTX150 özel tekstil destek tabakası sayesinde mekanın ses ve ısı izolasyonuna katkı sağlar.
- Özellikle van ve minibüs kabinleri ile ticari araçların yanı sıra hafif trafik altındaki alanlarda da kullanılabilir.
- %100 çevre dostu ve geri dönüştürülebilir bir zemin kaplamasıdır.
- Standart ürün geri dönüştürülmüş hammadde içerir.
- Standart ürünün kimyasal yapısı, geri dönüşüm muhtevası nedeniyle izlenebilir değildir.
- Orijinal hammadde kullanımı opsiyoneldir.
- Özellikle güçlendirilmiş yüzeyi sayesinde kolayca temizlenebilir.
- Emici tekstil tabanı OTX150 ve esnek ürün yapısı sayesinde çok çeşitli yüzeylerde kolaylıkla uygulanabilir.

### Ölçüler:

Ambalaj: Rulo  
Genişlik: 200 cm  
Rulo Boyu: 10 - 18 Mtül  
Arka Yüzey: OTX150  
Kalınlık: 1,8 ve 2.00 mm

- Усиленное транспортное напольное покрытие и универсальное напольное покрытие
- Благодаря своей гибкой структуре, усиленному износостойкому слою и архитектуре изделия его удобно использовать не только в кabinах транспортных средств, но и в универсальных, бытовых и легких коммерческих помещениях.
- В зависимости от усиленной износостойкости это долговечное напольное покрытие Т-класса, Тип-1
- Благодаря специальному текстильному опорному слою OTX150 способствует звуко- и теплоизоляции помещения.
- Удобно специально для кабин фургонов и микроавтобусов и грузовых автомобилей, а также для зон с небольшим движением.
- Это 100% экологически чистое напольное покрытие, пригодное для вторичной переработки. Стандартная версия содержит переработанное сырье.
- Химическая структура стандартной версии не прослеживается из-за переработанного содержимого.
- Девственная структура не является обязательной.
- Благодаря специально усиленной поверхности его легко чистить.
- Его можно легко установить на различные
- поверхности благодаря впитывающей войлочной основе: OTX150 и гибкой структуре продукта.

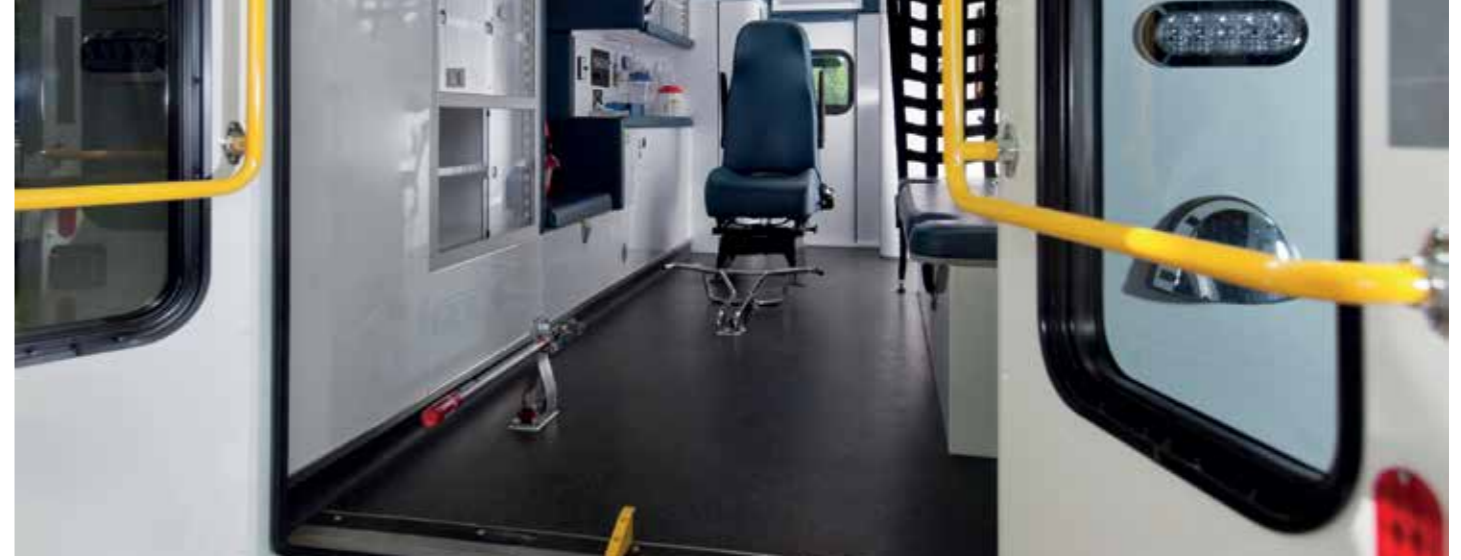

## Layer Diagrams



## Katman Şemaları



## Диаграммы слоев

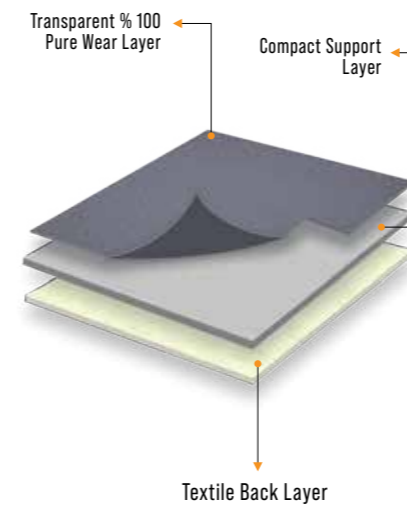

"Some products may use a different product architecture than the illustration above."

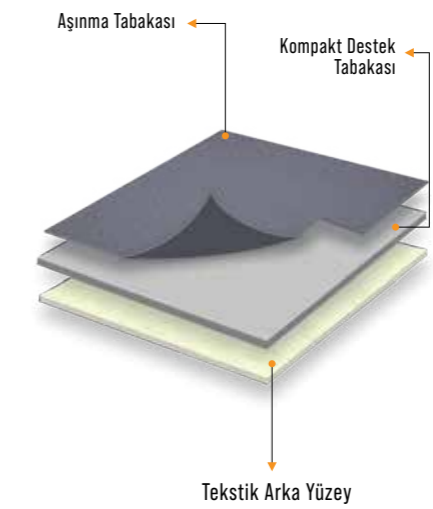

"Kimi ürünlerde, yukarıdaki gösterimden farklı ürün mimarisi kullanılabilir."

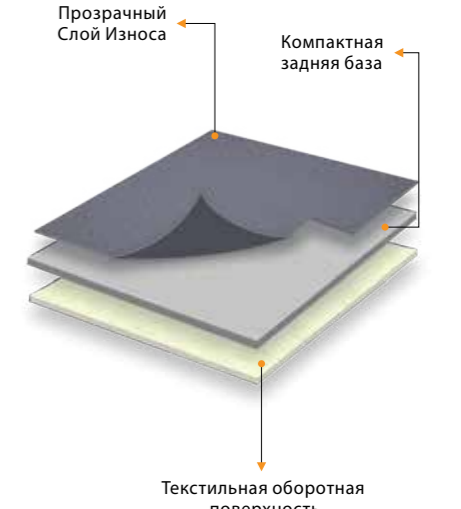

"Некоторые продукты могут использовать архитектуру продукта, отличную от той, что показана на рисунке выше."



RECYCLED PVC: YES

## TECHNICAL DATA SHEET

## PRODUCT IDENTIFICATION: OTOKAP EXTRA STRONG

## TECHNICAL PROPERTIES

DESCRIPTION	STANDARD	UNIT	PRODUCT							
			PARALI/ORTA PARA/MEGA/TRANSİT/PETEK/DAMA/PORTER				HEELPAD/ZİNCİR/AĞAÇ			
DESIGN			TX150	TX150	TX150	TX150	TX150	TX150	TX150	TX150
Back Layer										
Total Thickness	EN ISO 24346	mm	1.80 mm (min:-0.10 mm max: 0.13 mm)	2 mm (min:-0.10 mm max: 0.13 mm)	2.20 mm (min:-0.10 mm max: 0.13 mm)	2.20 mm (min:-0.10 mm max: 0.13 mm)	1.80 mm (min:-0.10 mm max: 0.13 mm)	2 mm (min:-0.10 mm max: 0.13 mm)	2.20 mm (min:-0.10 mm max: 0.13 mm)	2.20 mm (min:-0.10 mm max: 0.13 mm)
Wear Layer Thickness	EN ISO 24340	mm	0.20 mm (max:+%13 min: -%10)	0.30 mm (max:+%13 min: -%10)	0.30 mm (max:+%13 min: -%10)	0.55 mm (max:+%13 min: -%10)	0.20 mm (max:+%13 min: -%10)	0.30 mm (max:+%13 min: -%10)	0.30 mm (max:+%13 min: -%10)	0.55 mm (max:+%13 min: -%10)
Unit Area Mass	EN ISO 23997	g/m <sup>2</sup>	2210 g/m <sup>2</sup> (max:+%13 min: -%10)	2450 g/m <sup>2</sup> (max:+%13 min: -%10)	2850 g/m <sup>2</sup> (max:+%13 min: -%10)	2760 g/m <sup>2</sup> (max:+%13 min: -%10)	2300 g/m <sup>2</sup> (max:+%13 min: -%10)	2550 g/m <sup>2</sup> (max:+%13 min: -%10)	2965 g/m <sup>2</sup> (max:+%13 min: -%10)	2850 g/m <sup>2</sup> (max:+%13 min: -%10)
Hardness	DIN 53505	ShA	85-90	85-90	85-90	85-90	85-90	85-90	85-90	85-90
Roll Width	EN ISO 24341	m	2	2	2	2	2	2	2	2
Roll Length	EN ISO 24341	m	18	18	18	18	18	18	18	18
PERFORMANCE										
Dimensional Stability	EN ISO 23999	%	≤%0.4	≤%0.4	≤%0.4	≤%0.4	≤%0.4	≤%0.4	≤%0.4	≤%0.4
Curling	EN ISO 23999	mm	max:8	max:8	max:8	max:8	max:8	max:8	max:8	max:8
Tensile Strength Crosswise	EN ISO 527	N/mm <sup>2</sup>	Min: 3 N/mm <sup>2</sup>	Min: 3 N/mm <sup>2</sup>	Min: 3 N/mm <sup>2</sup>	Min: 3 N/mm <sup>2</sup>	Min: 3 N/mm <sup>2</sup>	Min: 3 N/mm <sup>2</sup>	Min: 3 N/mm <sup>2</sup>	Min: 3 N/mm <sup>2</sup>
Tensile strength Lengthwise	EN ISO 527	N/mm <sup>2</sup>	Min: 3 N/mm <sup>2</sup>	Min: 3 N/mm <sup>2</sup>	Min: 3 N/mm <sup>2</sup>	Min: 3 N/mm <sup>2</sup>	Min: 3 N/mm <sup>2</sup>	Min: 3 N/mm <sup>2</sup>	Min: 3 N/mm <sup>2</sup>	Min: 3 N/mm <sup>2</sup>
Flexibility	EN ISO 24344		No Crack	No Crack	No Crack	No Crack	No Crack	No Crack	No Crack	No Crack

In case, you otherwise specify, standard OtoKap Extra Strong products are produced with recycled PVC ingredients which the chemical history is not certified and is accepted as unknown. The chemical structure, ingredients, and chemical behaviors, including fire behavior, cannot be

warranted and are not declarable because of this recycled PVC content. However, is an optional variant and is produced with only

virgin raw material ingredients, and thus its chemical structure and chemical behaviors, including fire behavior, is totally declarable. Please kindly contact your supplier for further information.

\* Sipariş geçmeden önce, lütfen güncel TDS verilerini talep edin.

\* Before placing an order, please request up-to-date TDS data.

Recycled PVC Content	✓	✗
CE	✗	✓
Wear Group	Group T	Group T
Binder Content	Type 1	Type 1
Abrasion Resistance	✓	✓
100% Recyclable	✓	✓
Flexibility	✓	✓
Easy to Clean	✓	✓
Underfoot Comfort	✓	✓
Chemical Structure Declaration	✗	✓
Horizontal Burning Declaration	✗	✓
Burning Behavior Declaration	✗	✓
Price	\$	\$ \$

Transport Floor Coverings

Araç İçi Zemin Kaplamaları

Автомобильные  
Напольные покрытия

## ORTA PARALI (310)



## PETEK (205)



\*\* Real products may differ from above images. Please kindly note to ask for real products samples before confirming your order.

\*\* Gerçek ürünler yukarıdaki resimlerden farklı olabilir. Lütfen siparişinizi vermeden önce gerçek ürün numunelerini istemeyi unutmayın.

\*\* Реальные продукты могут отличаться от изображений выше. Пожалуйста, обратите внимание, чтобы запросить образцы реальной продукции перед подтверждением вашего заказа.

Transport Floor Coverings

Araç İçi Zemin Kaplamaları

Автомобильные  
Напольные покрытия

## DAMA (800)



## PORTER (900)



## AĞAÇ (590)

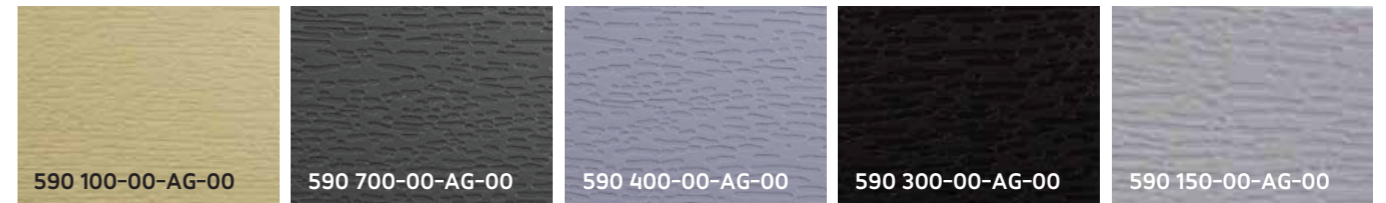

## LINEAR (550)

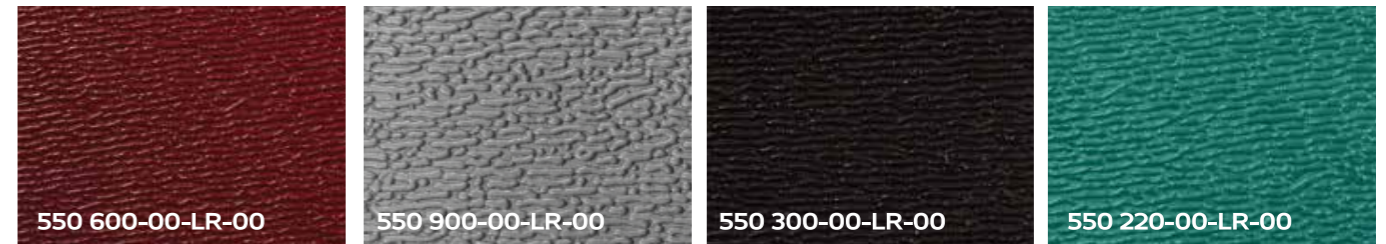

\*\* Real products may differ from above images. Please kindly note to ask for real products samples before confirming your order.

\*\* Gerçek ürünler yukarıdaki resimlerden farklı olabilir. Lütfen siparişinizi vermeden önce gerçek ürün numunelerini istemeyi unutmayın.

\*\* Реальные продукты могут отличаться от изображений выше. Пожалуйста, обратите внимание, чтобы запросить образцы реальной продукции перед подтверждением вашего заказа.

Transport Floor Coverings

Araç İçi Zemin Kaplamaları

Автомобильные  
Напольные покрытия

## ZİNCİR ( 600 )



## CRAFT ( 450 )

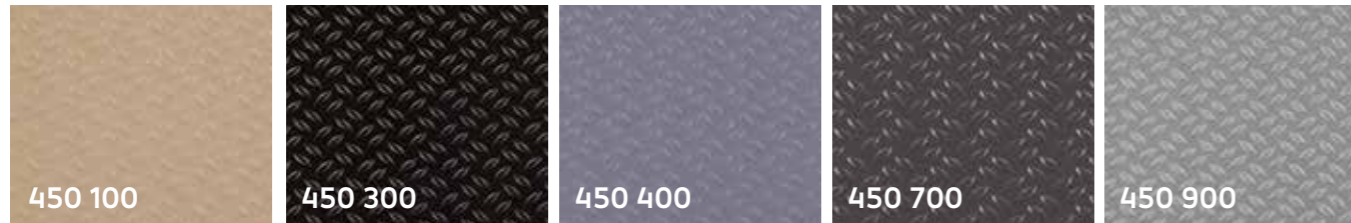

## PORTO ( 620 )

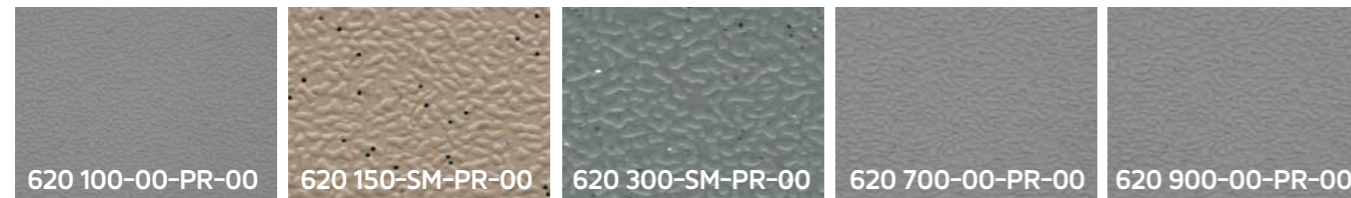

\*\* Real products may differ from above images. Please kindly note to ask for real products samples before confirming your order.

\*\* Gerçek ürünler yukarıdaki resimlerden farklı olabilir. Lütfen siparişinizi vermeden önce gerçek ürün numunelerini istemeyi unutmayın.

\*\* Реальные продукты могут отличаться от изображений выше. Пожалуйста, обратите внимание, чтобы запросить образцы реальной продукции перед подтверждением вашего заказа.

Transport Floor Coverings

Araç İçi Zemin Kaplamaları

Автомобильные  
Напольные покрытия

## HEELPAD ( 700 )



\*\* Real products may differ from above images. Please kindly note to ask for real products samples before confirming your order.

\*\* Gerçek ürünler yukarıdaki resimlerden farklı olabilir. Lütfen siparişinizi vermeden önce gerçek ürün numunelerini istemeyi unutmayın.

\*\* Реальные продукты могут отличаться от изображений выше. Пожалуйста, обратите внимание, чтобы запросить образцы реальной продукции перед подтверждением вашего заказа.

Transport Floor Coverings

Araç İçi Zemin Kaplamaları

Автомобильные  
Напольные покрытия

## MEGA ( 400 )



## PARA ( 105 )



\*\* Real products may differ from above images. Please kindly note to ask for real products samples before confirming your order.

\*\* Gerçek ürünler yukarıdaki resimlerden farklı olabilir. Lütfen siparişinizi vermeden önce gerçek ürün numunelerini istemeyi unutmayın.

\*\* Реальные продукты могут отличаться от изображений выше. Пожалуйста, обратите внимание, чтобы запросить образцы реальной продукции перед подтверждением вашего заказа.

Transport Floor Coverings

Araç İçi Zemin Kaplamaları

Автомобильные  
Напольные покрытия

## TRANSİT ( 155 )

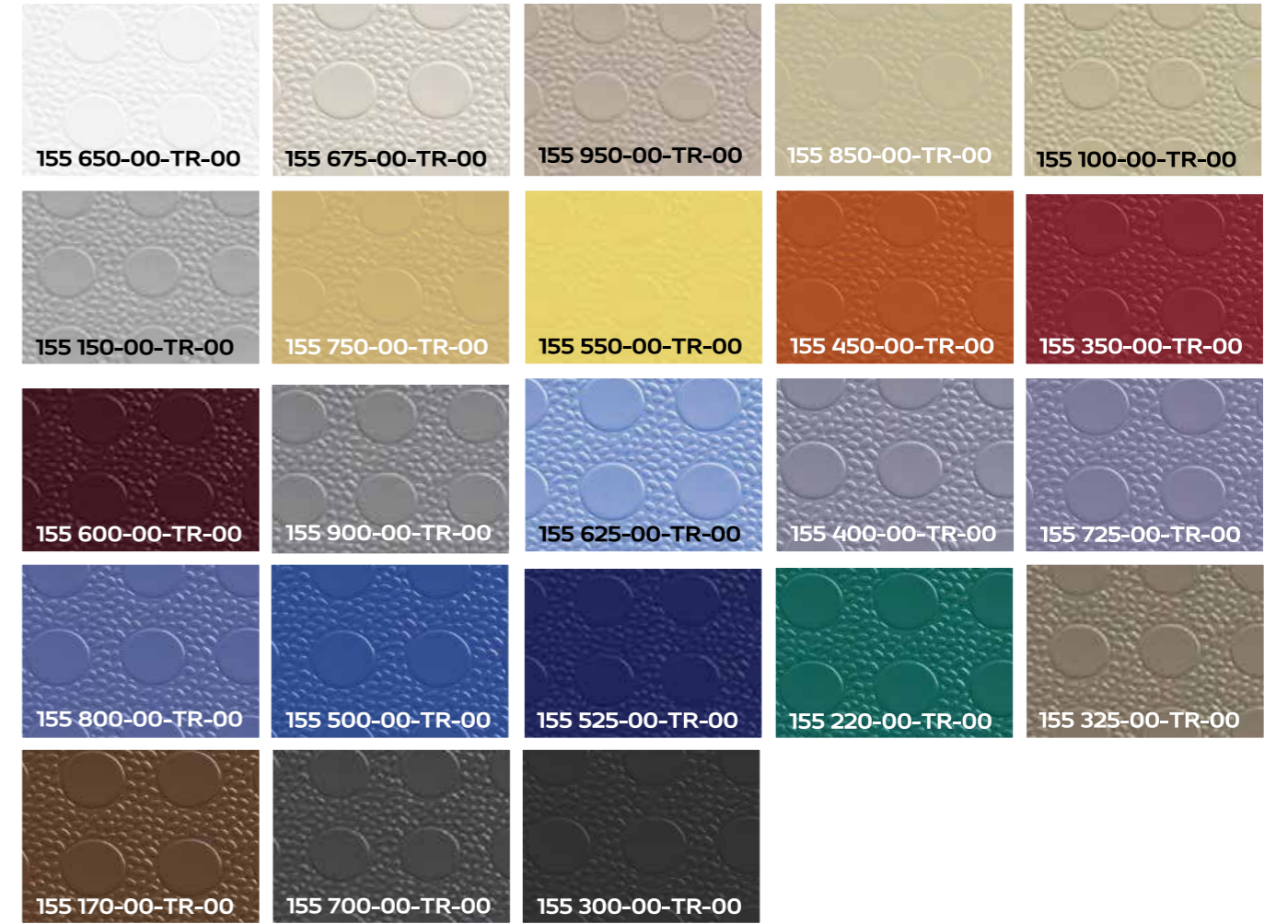

## FLECKY



## CELLNETTE ( 325 )



\*\* Real products may differ from above images. Please kindly note to ask for real products samples before confirming your order.

\*\* Gerçek ürünler yukarıdaki resimlerden farklı olabilir. Lütfen siparişinizi vermeden önce gerçek ürün numunelerini istemeyi unutmayın.

\*\* Реальные продукты могут отличаться от изображений выше. Пожалуйста, обратите внимание, чтобы запросить образцы реальной продукции перед подтверждением вашего заказа.



General Purpose  
Floor Coverings

Genel Amaçlı  
Zemin Kaplamaları

Покрyтия общего  
Назначенiя

**ECOİKAP**



**net**  
FLOOR COVERINGS  
[www.netfloor.com.tr](http://www.netfloor.com.tr)



## General Purpose Floor Coverings



## Genel Amaçlı Zemin Kaplamaları



## Покрyтия общего Назначения



- Is a general-purpose covering material.
- Is price-efficient.
- Does not absorb water.
- Has a light and thin structure.
- ECOKAP is more durable than foam based alternatives with its dense compact structure.
- Can also be used in under light human traffic.
- Has a wide visual range with its different colors and patterns.
- Is environmental friendly and %100 recyclable.

- Genel amaçlı bir kaplama malzemesidir.
- Ekonomiktir.
- Su emmez.
- İnce ve hafiftir.
- ECOKAP daha yoğun kompakt yapısı ile köpük tabanlı şişirilmiş alternatiflerinden daha mukavimdir.
- Hafif insan trafikli alanlarda kullanılabilir.
- Farklı renk ve desen çeşitleriyle geniş bir görsellik yelpazesine sahiptir.
- Çevre dostudur ve %100 geri dönüşümlü bir malzemedir.

- Покрyтие общего назначения.
- Экономичный.
- Не впитывает воду.
- Тонкий и легкий.
- ECOKAP, обладающий более плотной структурой, является более устойчивым по сравнению с надувными аналогами с основанием из пенопласта.
- Могут использоваться на территориях с небольшим движением людей.
- Обладают широким ассортиментом цветом и узоров.
- Является экологически чистым и 100% утилизируемым.



## Layer Diagrams



## Katman Şemaları



## Диаграммы слоев

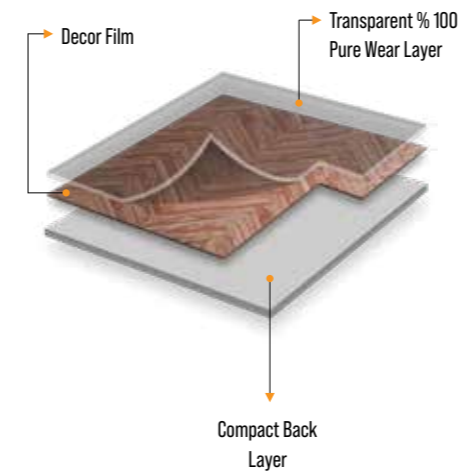

"Some products may use a different product architecture than the illustration above."

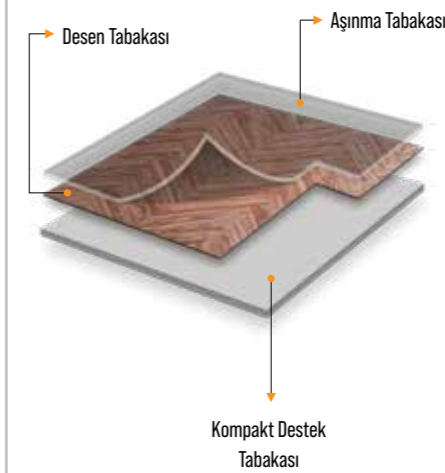

"Kimi ürünlerde, yukarıdaki gösterimden farklı ürün mimarisi kullanılabilir."



"Некоторые продукты могут использовать архитектуру продукта, отличную от той, что показана на рисунке выше."



TECHNICAL DATA SHEET							
		RECYCLED PVC : OK PURGUARD : OK					RECYCLED PVC : OK ECOSHELL : OK
SPECIFICATION	STANDARD	EcoKap					EcoKap LIFE
Total Thickness	EN ISO 24346	0.60 mm (min:-0.10 mm max: 0.13 mm)	0.70 mm (min:-0.10 mm max: 0.13 mm)	1 mm (min:-0.10 mm max: 0.13 mm)	1.20 mm (min:-0.10 mm max: 0.13 mm)	1.50 mm (min:-0.10 mm max: 0.13 mm)	0.70 mm (min:-0.15 mm max: 0.18 mm)
Total Weight	EN ISO 23997	980 g/m <sup>2</sup> (max:+%13 min: -%10)	1140 g/m <sup>2</sup> (max:+%13 min: -%10)	1490 g/m <sup>2</sup> (max:+%13 min: -%10)	2020 g/m <sup>2</sup> (max:+%13 min: -%10)	2510 g/m <sup>2</sup> (max:+%13 min: -%10)	1180 g/m <sup>2</sup> (max:+%13 min: -%10)
Roll Width	EN ISO 24341	2 m	2 m	2 m	2 m	2 m	2 m
Roll Length	EN ISO 24341	25 m	25 m	25 m	25 m	25 m	30 m
PERFORMANCE							
Flexibility	EN ISO 24344	No Crack	No Crack	No Crack	No Crack	No Crack	No Crack
Tensile Strength Crosswise	EN ISO 527	Min: 3 N/mm <sup>2</sup>	Min: 3 N/mm <sup>2</sup>	Min: 3 N/mm <sup>2</sup>	Min: 3 N/mm <sup>2</sup>	Min: 3 N/mm <sup>2</sup>	Min: 3 N/mm <sup>2</sup>
Tensile Strength Lengthwise	EN ISO 527	Min: 3 N/mm <sup>2</sup>	Min: 3 N/mm <sup>2</sup>	Min: 3 N/mm <sup>2</sup>	Min: 3 N/mm <sup>2</sup>	Min: 3 N/mm <sup>2</sup>	Min: 3 N/mm <sup>2</sup>

In case, you otherwise specify, standard EcoKap products are produced with recycled PVC ingredients which the chemical history is not certified and is accepted as unknown. The chemical structure, ingredients, and chemical behaviors, including fire behavior, cannot be warranted and

are not declarable because of this recycled PVC content. However, is an optional variant and is produced with only virgin raw

material ingredients, and thus its chemical structure and chemical behaviors, including fire behavior, is totally declarable. Please kindly contact your supplier for further information.

\* Sipariş geçmeden önce, lütfen güncel TDS verilerini talep edin.

\* Before placing an order, please request up-to-date TDS data.

Recycled PVC Content	✓	✗
CE	✗	✓
Wear Layer	✓	✓
100% Recyclable	✓	✓
Flexibility	✓	✓
Easy to Clean	✓	✓
Chemical Structure Declaration	✗	✓
Burning Behavior Declaration	✗	✓
Price	\$	\$ \$

General Purpose Floor Coverings

Genel Amaçlı Zemin Kaplamaları

Покрyтия общего  
Напольного покрытия

## TRADITION ( 330 / 331 / 332 )



## MUNDI ( 296 / 297 )

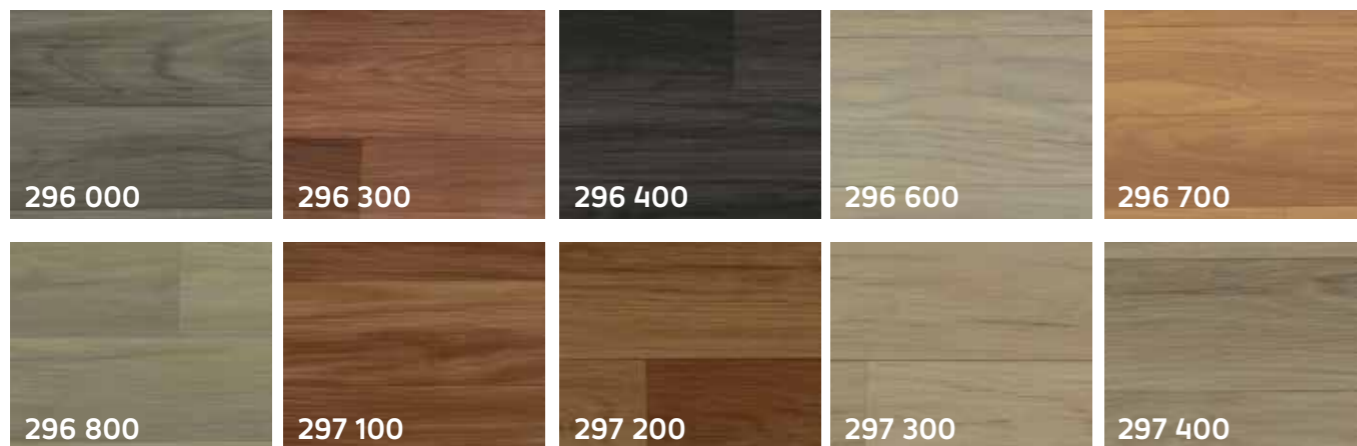

\*\* Real products may differ from above images. Please kindly note to ask for real products samples before confirming your order.

\*\* Gerçek ürünler yukarıdaki resimlerden farklı olabilir. Lütfen siparişinizi vermeden önce gerçek ürün numunelerini istemeyi unutmayın.

\*\* Реальные продукты могут отличаться от изображений выше. Пожалуйста, обратите внимание, чтобы запросить образцы реальной продукции перед подтверждением вашего заказа.

General Purpose Floor Coverings

Genel Amaçlı Zemin Kaplamaları

Покрyтия общего  
Напольного покрытия

## GAIA ( 100 / 101 )



## LAMINANT ( E15 )

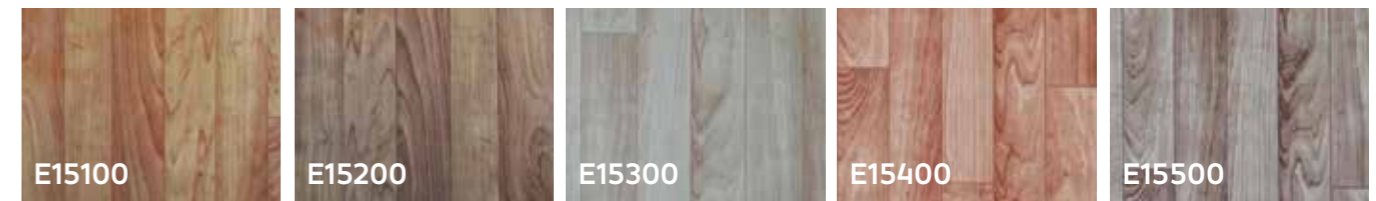

## ÇAVUŞ ( E05 )

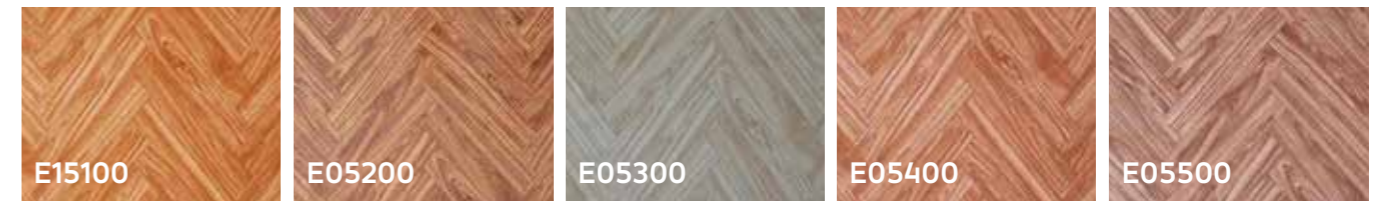

## KUTU ( E10 )

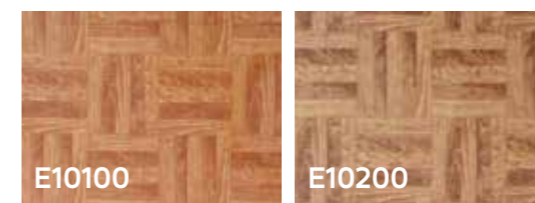

## KARIŞIK ( E00 )

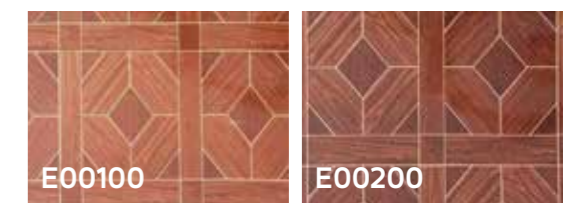

\*\* Real products may differ from above images. Please kindly note to ask for real products samples before confirming your order.

\*\* Gerçek ürünler yukarıdaki resimlerden farklı olabilir. Lütfen siparişinizi vermeden önce gerçek ürün numunelerini istemeyi unutmayın.

\*\* Реальные продукты могут отличаться от изображений выше. Пожалуйста, обратите внимание, чтобы запросить образцы реальной продукции перед подтверждением вашего заказа.

General Purpose Floor Coverings

Genel Amaçlı Zemin Kaplamaları

Покрyтия общего  
Назначенiя поКрyблiтi/иН

## KARE (E25)



## GÜL (E20)

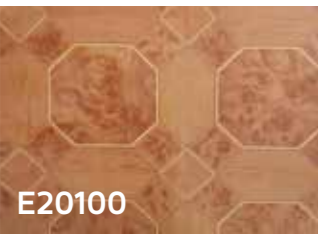

## YAPRAK (E030)

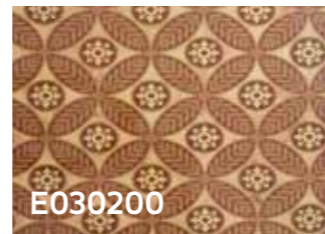
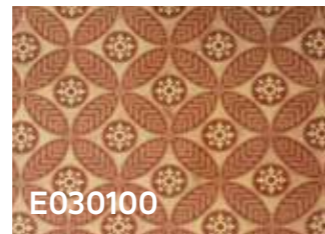

## YILDIZ (E10)

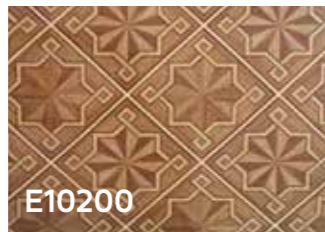
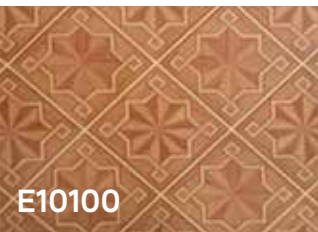

## YILDIZ (E10)

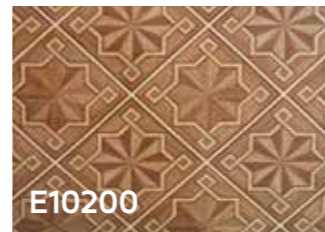
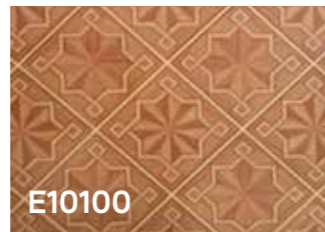

## NACRÉ

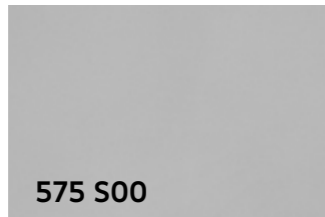
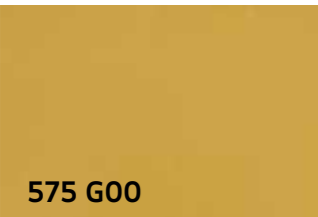

## HAMMAM (640)

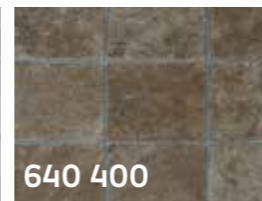
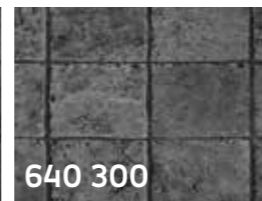

\*\* Real products may differ from above images. Please kindly note to ask for real products samples before confirming your order.

\*\* Gerçek ürünler yukarıdaki resimlerden farklı olabilir. Lütfen siparişinizi vermeden önce gerçek ürün numunelerini istemeyi unutmayın.

\*\* Реальные продукты могут отличаться от изображений выше. Пожалуйста, обратите внимание, чтобы запросить образцы реальной продукции перед подтверждением вашего заказа.

General Purpose Floor Coverings

Genel Amaçlı Zemin Kaplamaları

Покрyтия общего  
Назначенiя поКрyблiтi/иН

## MYRA

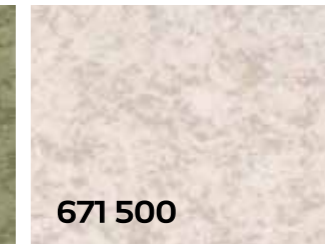
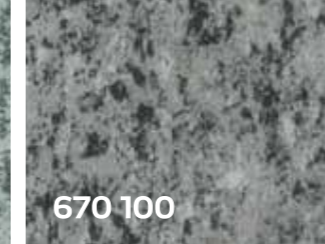

## HYDRO ( 960 )

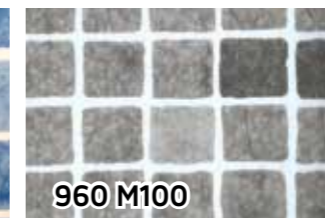
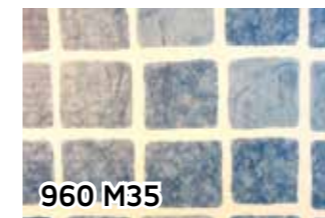
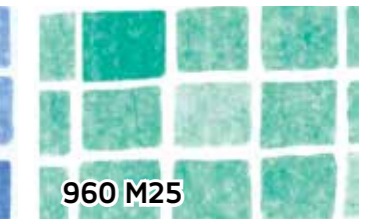
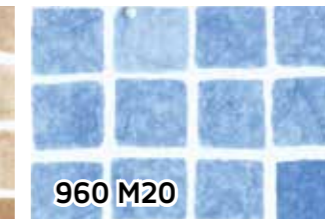
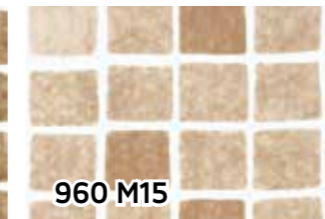

\*\* Real products may differ from above images. Please kindly note to ask for real products samples before confirming your order.

\*\* Gerçek ürünler yukarıdaki resimlerden farklı olabilir. Lütfen siparişinizi vermeden önce gerçek ürün numunelerini istemeyi unutmayın.

\*\* Реальные продукты могут отличаться от изображений выше. Пожалуйста, обратите внимание, чтобы запросить образцы реальной продукции перед подтверждением вашего заказа.

General Purpose Floor Coverings

Genel Amaçlı Zemin Kaplamaları

Покрyтия общего  
Напольного покрытия

## MESHE



Multi-Layered  
Compact Vinyl Flooring

Çok Katmanlı  
Kompakt Vinil Döşeme

Многослойный Компактный  
Виниловый пол

# PopFlex



\*\* Real products may differ from above images. Please kindly note to ask for real products samples before confirming your order.

\*\* Gerçek ürünler yukarıdaki resimlerden farklı olabilir. Lütfen siparişinizi vermeden önce gerçek ürün numunelerini istemeyi unutmayın.

\*\* Реальные продукты могут отличаться от изображений выше. Пожалуйста, обратите внимание, чтобы запросить образцы реальной продукции перед подтверждением вашего заказа.

# net

FLOOR COVERINGS

www.netfloor.com.tr



## Heterogeneous Contract Floor Coverings



## Heterojen Kontrat Zemin Kaplamaları



КоНтраКТНhle rероренНhle  
HanонНhle нoКрбиТI/ИH



- Price efficient, residential floor covering.
- It can be used in residential areas.. It is a floor covering that is especially resistant to static loads with its high density among household products.
- With its felt-supported compact structure, it provides more durability and longer service life compared to its foam-based alternatives.
- As supplying good degree of sound and heat insulation, it will increase comfort level
- Thanks to its felt supported compact structure, it seriously contributes to sound and heat insulation of the room
- It is a price-oriented floor covering.
- Low-traffic general use, low-traffic areas, domestic areas.
- It is a 100% recyclable floor covering.
- Standard popflex contains recycled PVC.
- Virgin production is optional.
- It contains environmentally friendly recycled raw materials.
- Being a recyclable material, it has no chemical content and no traceability.
- It is easy to clean and suitable for mop cleaning.
- Due to its compact felt-based structure, it fits on the floor easily. It is applied to the entire surface by applying water-based adhesive.

- Eysel kullanıma uygun, ekonomik zemin kaplaması.
- Eysel alanlarda kullanılabilir. Eysel ürünler arasında yüksek öz kütlesiyle özellikle statik yüklere dayanıklı bir zemin kaplamasıdır.
- Kompakt ve keçe ilaveli yapısı ile köpük tabanlı muadillerine göre daha mukavim kullanım imkânı sağlar.
- Ses ve ısı izolasyonu sağladığı için konforlu bir kullanım imkânı sağlar.
- Keçe ilaveli kompakt yapısı sayesinde bulunduğu ortamda ses ve ısı izolasyonuna katkı sağlar.
- Fiyat odaklı bir zemin kaplamasıdır.
- Trafiği düşük genel kullanım, düşük trafikli alanlar, evsel alanlar.
- %100 geri dönüştürülebilir bir zemin kaplamasıdır.
- Standart popflex, geri dönüştürülmüş PVC içerir.
- PopFlex opsiyonel olarak orjinal hammaddeyle de üretilebilir.
- Geri dönüşümlü bir malzeme olmasından dolayı, kimyasal içerik ve izlenebilirliği yoktur.
- Moplu temizliğe uygun kolay temizlenebilir.
- Keçe tabanlı kompakt yapısı sayesinde zemine kolayca oturur. Tüm yüzeye su bazlı yapıştırıcı sürülerek uygulanır.

- Экономичное напольное покрытие, подходящее для бытового использования.
- Подходит для использования в бытовых помещениях. Это напольное покрытие, которое особенно устойчиво к статическим нагрузкам благодаря своей высокой плотности среди изделий для бытового применения.
- Благодаря своей компактной структуре с войлоком продукт обеспечивает более долговечное использование по сравнению со своими аналогами на основе пены.
- Обеспечивает комфорт использования, так как имеет свойства звуковой и тепловой изоляции.
- Благодаря своей компактной структуре с войлоком продукт обеспечивает звуковую и тепловую изоляцию в помещении применения.
- Места общего пользования с малой проходимостью, площади с малой проходимостью, жилые помещения.
- Это на 100% перерабатываемое напольное покрытие.
- Стандартный Popflex содержит переработанный ПВХ.
- Изготовка из первичного сырья является опциональным вариантом.
- Содержит экологически чистое, перерабатываемое сырье.
- Поскольку это перерабатываемый материал, он не содержит химических веществ и не подлежит прослеживаемости.
- Легко чистится и подходит для очищения тряпкой.
- Компактная войлочная поверхность основы способствует легкой укладке покрытия. Применяется посредством нанесения клея на водной основе на всю поверхность покрытия.



## Layer Diagrams



## Katman Şemaları



## Диаграммы слоев

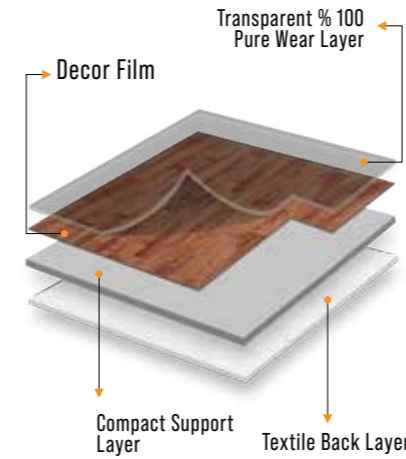

"Some products may use a different product architecture than the illustration above."

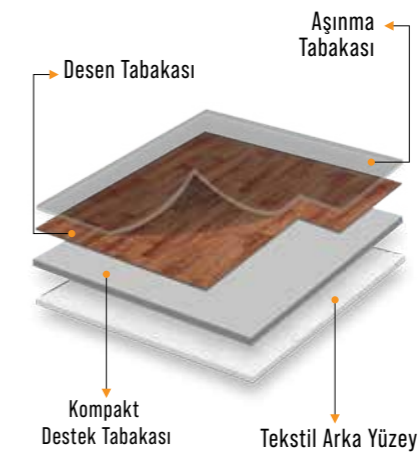

"Kimi ürünlerde, yukarıdaki gösterimden farklı ürün mimarisi kullanılabilir."



"Некоторые продукты могут использовать архитектуру продукта, отличную от той, что показана на рисунке выше."

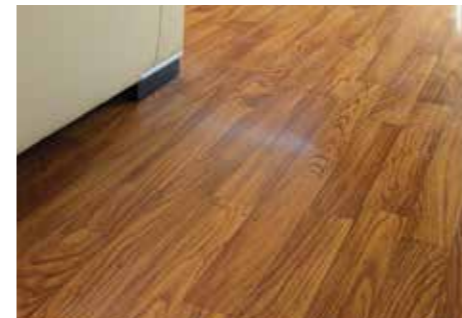







RECYCLED PVC : OK

## TECHNICAL DATA SHEET

Product Group: POPFLEX-1.40 mm

## TECHNICAL PROPERTIES

SPECIFICATION	STANDARD	PRODUCT
 Total Thickness	EN ISO 24346	1.40 mm (min:-0.10 mm max: 0.13 mm)
 Wear Layer Thickness	EN ISO 24340	0.03 mm (max:+%13 min: -%10)
Total Weight	EN ISO 23997	1560 g/m <sup>2</sup> (max:+%13 min: -%10)
 Roll Width	EN ISO 24341	Max: 2 m
 Roll Length	EN ISO 24341	Max: 30 m
PERFORMANCE		
Back Layer		TX150S
 Dimensional Stability	EN ISO 23999	≤%0.4
 Flexibility	EN ISO 24344	No Crack
Tensile Strength Crosswise	EN ISO 527	Min: 3 N/mm <sup>2</sup>
Tensile Strength Lengthwise	EN ISO 527	Min: 3 N/mm <sup>2</sup>

In case, you otherwise specify, standard PopFlex products are produced with recycled PVC ingredients which the chemical history is not certified and is accepted as unknown. The chemical structure, ingredients, and chemical behaviors, including fire behavior, cannot be warranted and

are not declarable because of this recycled PVC content. However,  is an optional variant and is produced with only virgin raw

material ingredients, and thus its chemical structure and chemical behaviors, including fire behavior, is totally declarable. Please kindly contact your supplier for further information.

\* Sipariş geçmeden önce, lütfen güncel TDS verilerini talep edin.

\* Before placing an order, please request up-to-date TDS data.

Recycled PVC Content	✓	✗
<b>CE</b>	✗	✓
Wear Group	Group T	Group T
Binder Content	Type 1	Type 1
Abrasion Resistance	✓	✓
100% Recyclable	✓	✓
Flexibility	✓	✓
Easy to Clean	✓	✓
Chemical Structure Declaration	✗	✓
Burning Behavior Declaration	✗	✓
Price	\$	\$ \$

Heterogeneous Contract  
Floor Coverings

Heterojen Kontrat  
Zemin Kaplamaları

КоНТраКТНble rereporeHHble  
HanonbHble noKpbITI/IH

## LAMINANT ( E15 / E16 )

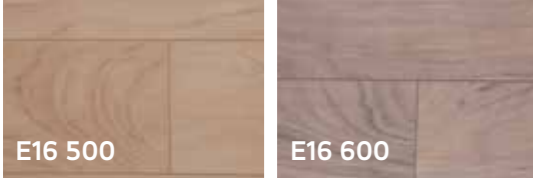
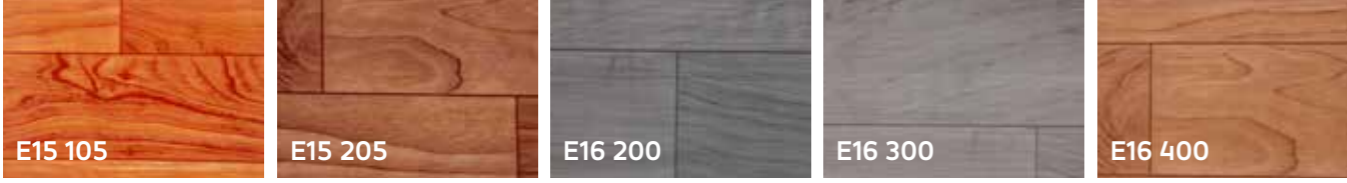

## KUTU ( E10 )

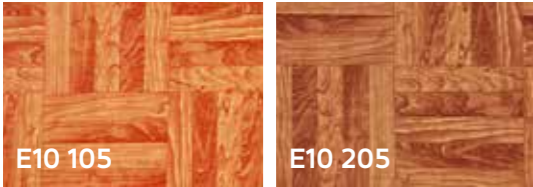

## ÇAVUŞ ( E05 )

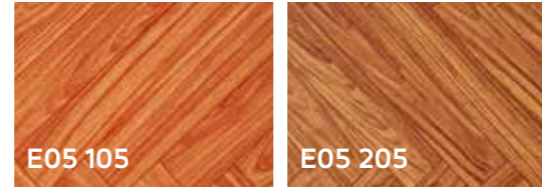

## KARIŞIK ( E00 )



## KARE ( E25 )

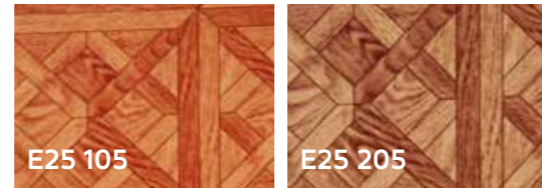

## EGELİ ( 530 )



## ASIA ( 480 )



## VEGA ( 891 )

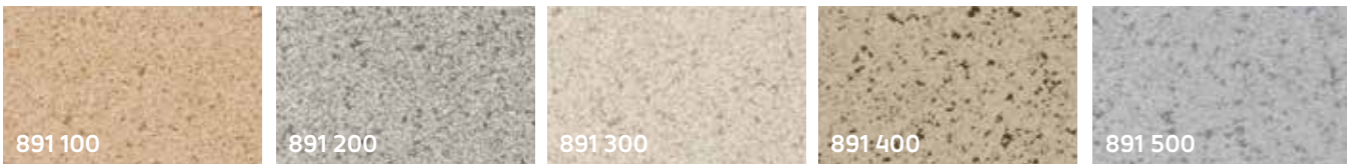

\*\* Real products may differ from above images. Please kindly note to ask for real products samples before confirming your order.

\*\* Gerçek ürünler yukarıdaki resimlerden farklı olabilir. Lütfen siparişinizi vermeden önce gerçek ürün numunelerini istemeyi unutmayın.

\*\* Реальные продукты могут отличаться от изображений выше. Пожалуйста, обратите внимание, чтобы запросить образцы реальной продукции перед подтверждением вашего заказа.



PopFlex  
Lite

Economic Heterogeneous Contract  
Floor Coverings

Ekonomik Heterojen Kontrat  
Zemin Kaplamaları

Экономичный КоНТраКТНble rereporeHHble  
HanonbHble noKpbITI/IH

# PopFlex Lite



net  
FLOOR COVERINGS

www.netfloor.com.tr



## Economic Heterogeneous Contract Floor Coverings



## Ekonomik Heterojen Kontrat Zemin Kaplamaları



## Экономичный КоНТраКТНhle rерepopеННhle HanonbHhle noKpbITИ/ИH



• An economical residential floor covering, suitable for use in low-traffic areas.

• Unlike standard PopFlex products, it does not include a wear layer. Instead, it features EcoShell surface protection.

• Offers elegant and modern design options with a variety of patterns and colors.

• With its felt-backed compact structure, it contributes to sound and thermal insulation, ensuring comfortable use.

• Specially developed as an economical option.

• Standard PopFlex Lite is produced from recycled PVC. Optionally, PopFlex Lite can also be manufactured using virgin raw material.

• 100% recyclable floor covering.

• Since standard products are produced with recycled PVC, their chemical structure, ingredients, and chemical behaviors cannot be warranted.

• Easy to clean and suitable for mop cleaning.

• Thanks to its compact felt-based structure, it fits on the floor easily. It is applied to the entire surface by applying water-based adhesive.

• Trafiği düşük alanlarda kullanıma uygun, fiyatlı odaklı evsel zemin kaplamasıdır.

• Standart PopFlex ürünlerinden farklı olarak aşınma tabakası barındırmaz. Bunun yerine EcoShell yüzey koruması mevcuttur.

• Şık ve modern tasarıma sahip desen ve renk seçeneklerine sahiptir.

• Keçe ilaveli kompakt yapısı ile bulunduğu ortamda ses ve ısı izolasyonuna katkısı sayesinde konforlu bir kullanım sağlar.

• Ekonomik bir seçenek olması için özel olarak geliştirilmiştir.

• Standart PopFlex Lite geri dönüştürülmüş PVC'den üretilir. PopFlex Lite opsiyonel olarak orijinal hammaddeyle de üretilebilir.

• %100 geri dönüştürülebilir bir zemin kaplamasıdır.

• Geri dönüşümlü bir malzeme olmasından dolayı, kimyasal içerik bilgisi ve izlenebilirliği yoktur.

• Kolay temizlenebilir bir üründür ve mopl temizliğe uygundur.

• Keçe tabanlı kompakt yapısı sayesinde zemine kolayca oturur. Tüm yüzeye su bazlı yapıştırıcı sürülerek uygulanır.

• Экономичное напольное покрытие, подходящее для бытового использования.

• В отличие от стандартных продуктов PopFlex, не имеет защитного слоя износа. Вместо него используется покрытие EcoShell.

• Широкий цветовой выбор со стильным дизайном и современными линиями.

• Благодаря войлочной основе обеспечивает звуко-теплоизоляцию.

• Специально разработано как экономичный вариант.

• Стандартный материал Popflex Lite содержит переработанный PVC. При желании можно изготовить из исходного сырья.

• Это на 100% перерабатываемое напольное покрытие.

• Поскольку это перерабатываемый материал, мы не берем на себя обязательства по его химическому составу и отслеживаемости.

• Легко чистится и подходит для очищения тряпкой.

• Компактная войлочная поверхность основы способствует легкой укладке покрытия. Применяется посредством нанесения клея на водной основе на всю поверхность покрытия.



## Layer Diagrams



## Katman Şemaları



## Диаграммы слоев

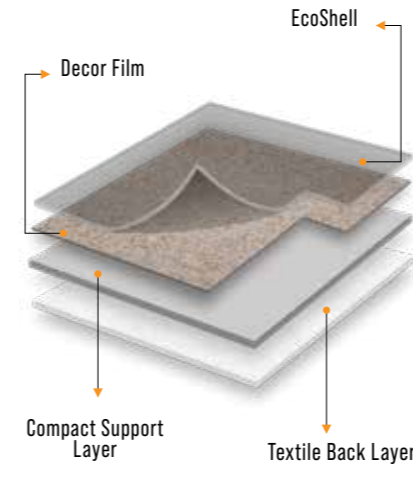

"Some products may use a different product architecture than the illustration above."

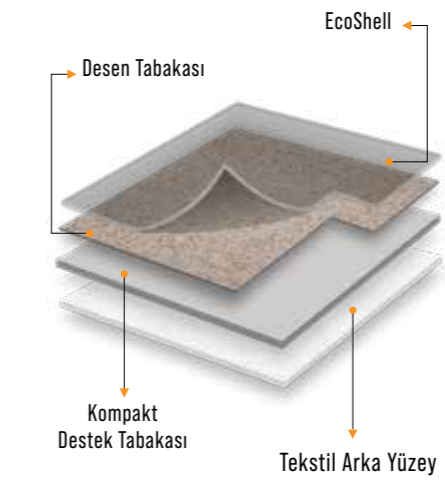

"Kimi ürünlerde, yukarıdaki gösterimden farklı ürün mimarisini kullanılabılır."



"Некоторые продукты могут использовать архитектуру продукта, отличную от той, что показана на рисунке выше."



RECYCLED PVC : YES  
ECOSHELL : YES

## TECHNICAL DATA SHEET

Product Group: POPFLEX LITE - 1.40 mm

## TECHNICAL PROPERTIES

SPECIFICATION	STANDARD	PRODUCT
<b>Total Thickness</b>	EN ISO 24346	1.40 mm (min:-0.10 mm max: 0.13 mm)
<b>Total Weight</b>	EN ISO 23997	1510 g/m <sup>2</sup> (max: +%13 min: -%10)
<b>Roll Width</b>	EN ISO 24341	200 cm
<b>Roll Length</b>	EN ISO 24341	35 m
PERFORMANCE		
<b>Back Layer</b>		TX150S
<b>Flexibility</b>	EN ISO 24344	No Crack
<b>Tensile Strength Crosswise</b>	EN ISO 527	Min: 3 N/mm <sup>2</sup>
<b>Tensile Strength Lengthwise</b>	EN ISO 527	Min: 3 N/mm <sup>2</sup>

"In case, you otherwise specify, standard PopFlex Lite products are produced with recycled PVC ingredients which the chemical history is not certified and is accepted as unknown. The chemical structure, ingredients, and chemical behaviors, including fire behavior, cannot be warranted

and are not declarable because of this recycled PVC content. However,  is an optional variant and is produced with only virgin raw

material ingredients, and thus its chemical structure and chemical behaviors, including fire behavior, is totally declarable. Please kindly contact your supplier for further information.

\* Sipariş geçmeden önce, lütfen güncel TDS verilerini talep edin.

\* Before placing an order, please request up-to-date TDS data.

Recycled PVC Content	✓	✗
EcoShell	✓	✓
100% Recyclable	✓	✓
Flexibility	✓	✓
Easy to Clean	✓	✓
Chemical Structure Declaration	✗	✓
Burning Behavior Declaration	✗	✓
Price	\$	\$ \$

Economic Heterogeneous Contract  
Floor Coverings

Ekonomik Heterojen Kontrat  
Zemin Kaplamaları

Экономичный КоНТраКTHble гeгeрeрeHHble  
HанонbHble нoKpbITи/IH

## MESHE



## ASIA



\*\* Real products may differ from above images. Please kindly note to ask for real products samples before confirming your order.

\*\* Gerçek ürünler yukarıdaki resimlerden farklı olabilir. Lütfen siparişinizi vermeden önce gerçek ürün numunelerini istemeyi unutmayın.

\*\* Реальные продукты могут отличаться от изображений выше. Пожалуйста, обратите внимание, чтобы запросить образцы реальной продукции перед подтверждением вашего заказа.



Multi-Layered  
Compact Vinyl Flooring

Çok Katmanlı  
Kompakt Vinil Döşeme

Многослойный Компактный  
Виниловый пол

# PopFlex

Ultra



# net

FLOOR COVERINGS

www.netfloor.com.tr



## Multi-Layered Compact Vinyl Flooring



## Çok Katmanlı Kompakt Vinil Döşeme



## Многослойный Компактный Виниловый Пол



- Economical floor covering suitable for domestic use.
- Extensive colour options with stylish design and modern lines.
- Thanks to its compact structure, it is resistant to static loads with its high core mass.
- With its compact structure supported by felt, it is more impact-resistant than its foam-based equivalent.
- It contributes to sound and heat insulation thanks to its felt support.
- Unlike textile-based flooring materials such as carpets, it does not contain myths.
- It is a pricewise floor covering.
- It is used in low-traffic areas and domestic areas for general use.
- It is more than 2 times stronger than the standard Popflex with its increased wearing coat.
- It is a 100% recyclable floor covering.
- It includes standard Popflex Ultra recycled PVC. Optionally, it can also be produced with original raw material.
- As it is a recyclable material, its chemical content and traceability are not under our commitment.
- It is suitable for mopped cleaning and easy to clean.
- Thanks to its compact structure with a felt base, it easily fits on the floor. It is applied by applying water-based adhesive to the entire surface.

- Eysel kullanıma uygun, ekonomik zemin kaplaması.
- Şık tasarıma ve modern çizgisiyle geniş renk seçenekleri.
- Kompakt yapısı sayesinde yüksek öz kütlesiyle statik yüklerle dirençlidir.
- Keçe destekli kompakt yapısı ile köpük tabanlı muadillerine göre darbelerle daha mukavimdir.
- Keçe desteği sayesinde ses ve ısı izolasyonuna katkı sağlar.
- Halı gibi tekstil esaslı zemin kaplama malzemelerinden farklı olarak myth barındırmaz.
- Fiyat odaklı bir zemin kaplamasıdır.
- Genel kullanım amaçlı, düşük trafikli alanlar ile evsel alanlarda kullanılır.
- Arttırılmış aşınma tabakası ile standart Popflex'ten 2 katı aşkın daha güçlüdür.
- %100 geri dönüştürülebilir bir zemin kaplamasıdır.
- Standart Popflex Ultra geri dönüştürülmüş PVC içerir. Opsiyonel olarak orijinal hammaddeyle de üretilebilir.
- Geri dönüşümlü bir malzeme olmasından dolayı kimyasal içerik ve izlenebilirliği taahhüdümüz altında değildir.
- Moplu temizliğe uygun ve kolay temizlenebilir.
- Keçe tabanlı kompakt yapısı sayesinde zemine kolayca oturur. Tüm yüzeye su bazlı yapıştırıcı sürülerek uygulanır.

- Экономичное напольное покрытие, подходящее для бытового использования.
- Широкий цветовой выбор со стильным дизайном и современными линиями.
- Благодаря своей компактной структуре является устойчивым к статическим нагрузкам за счет высокой плотности.
- Благодаря своей компактной структуре с войлочной основой более устойчив к ударам, чем аналоги на пенопластовой основе.
- Благодаря войлочной основе обеспечивает звуко-теплоизоляцию.
- В отличие от напольных покрытий на текстильной основе, таких как ковролин, не содержит myth.
- Напольное покрытие, ориентированное на цену.
- Используется для общего пользования, мест с низкой проходимостью и жилых помещений.
- Более чем в 2 раза прочнее стандартного Popflex благодаря увеличенному слою износа.
- 100% перерабатываемое напольное покрытие.
- Стандартный материал Popflex Ultra содержит переработанный PVC. При желании можно изготовить из исходного сырья.
- Поскольку это перерабатываемый материал, мы не берем на себя обязательства по его химическому составу и отслеживаемости.
- Он подходит для чистки шваброй и легко моется.
- Благодаря своей компактной структуре на войлочной основе легко устанавливается на пол.
- Наносится на всю поверхность с помощью клея на водной основе.



## Layer Diagrams



## Katman Şemaları



## Диаграммы слоев

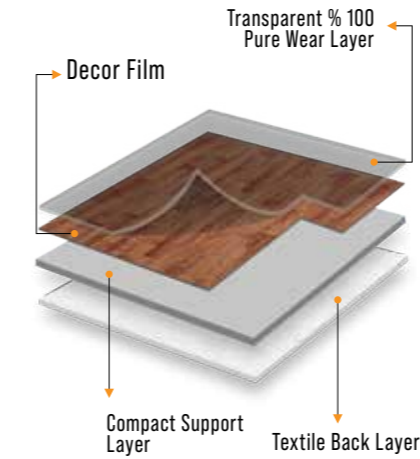

"Some products may use a different product architecture than the illustration above."

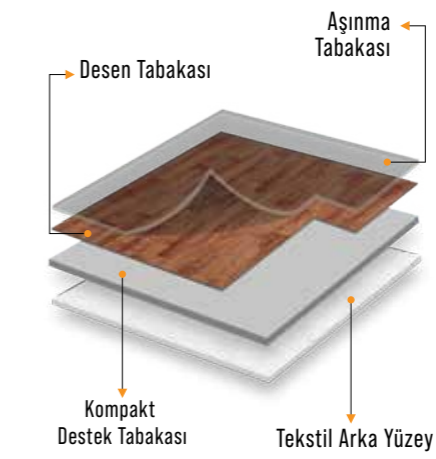

"Kimi ürünlerde, yukarıdaki gösterimden farklı ürün mimarisi kullanılabilir."

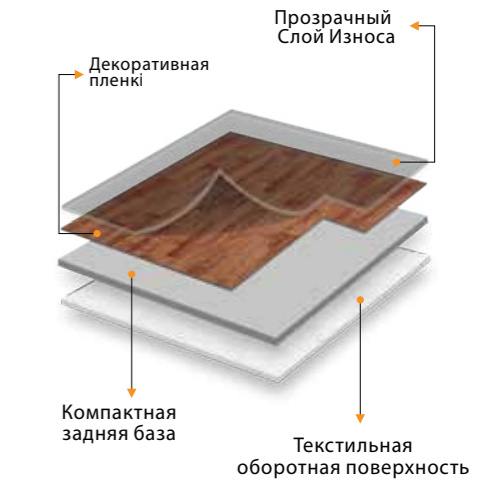

"Некоторые продукты могут использовать архитектуру продукта, отличную от той, что показана на рисунке выше."



RECYCLED PVC : YES

## TECHNICAL DATA SHEET

Product Group: POPFLEX ULTRA - 1.40 mm

## TECHNICAL PROPERTIES

SPECIFICATION	STANDARD	PRODUCT
Total Thickness	EN ISO 24346	1.40 mm (min:-0.10 mm max: 0.13 mm)
Wear Layer Thickness	EN ISO 24340	0.07 mm (max:+%13 min: -%10)
Total Weight	EN ISO 23997	1380 g/m <sup>2</sup> (max:+%13 min: -%10)
Roll Width	EN ISO 24341	Max: 2 m
Roll Length	EN ISO 24341	Max: 30 m
PERFORMANCE		
Back Layer		TX150S
Dimensional Stability	EN ISO 23999	≤%0.4
Flexibility	EN ISO 24344	No Crack
Tensile Strength Crosswise	EN ISO 527	Min: 3 N/mm <sup>2</sup>
Tensile Strength Lengthwise	EN ISO 527	Min: 3 N/mm <sup>2</sup>

In case, you otherwise specify, standard PopFlex Ultra products are produced with recycled PVC ingredients which the chemical history is not certified and is accepted as unknown. The chemical structure, ingredients, and chemical behaviors, including fire behavior, cannot be warranted

and are not declarable because of this recycled PVC content. However, is an optional variant and is produced with only virgin raw

material ingredients, and thus its chemical structure and chemical behaviors, including fire behavior, is totally declarable. Please kindly contact your supplier for further information.

\* Sipariş geçmeden önce, lütfen güncel TDS verilerini talep edin.

\* Before placing an order, please request up-to-date TDS data.

Recycled PVC Content	✓	✗
<b>CE</b>	✗	✓
Wear Group	Group T	Group T
Binder Content	Type 1	Type 1
Abrasion Resistance	✓	✓
100% Recyclable	✓	✓
Flexibility	✓	✓
Easy to Clean	✓	✓
Chemical Structure Declaration	✗	✓
Burning Behavior Declaration	✗	✓
Price	\$	\$ \$

Economic Printed Transport  
Floor Coverings

Ekonomik Araç İçi Baskılı  
Zemin Kaplamaları

Экономичный печатный транспорт  
напольные покрытия

## MESHE ( 630-631 )

630 100	630 200	630 300	630 400
630 500	630 600	630 700	630 800
630 900	631 000	631 100	631 200



PopFlex  
Extra

Economic Printed Transport  
Floor Coverings

Ekonomik Araç İçi Baskılı  
Kaplamaları

Экономичный печатный транспорт  
напольные покрытия

# PopFlex

Extra



\*\* Real products may differ from above images. Please kindly note to ask for real products samples before confirming your order.

\*\* Gerçek ürünler yukarıdaki resimlerden farklı olabilir. Lütfen siparişinizi vermeden önce gerçek ürün numunelerini istemeyi unutmayın.

\*\* Реальные продукты могут отличаться от изображений выше. Пожалуйста, обратите внимание, чтобы запросить образцы реальной продукции перед подтверждением вашего заказа.

# net

FLOOR COVERINGS

[www.netfloor.com.tr](http://www.netfloor.com.tr)



## Economic Printed Transport Floor Coverings



## Ekonomik Araç İçi Baskılı Zemin Kaplamaları



## Экономичный печатный транспорт напольные покрытия



- It is price-efficient printed floor covering for mainly vehicle cabins
- It can also be installed in areas with light human traffic
- It is a felt supported compact price-efficient transport floor covering
- It provides a good underfoot comfort thank to its felt backing
- It is more price efficient compared to alternatives.
- Areas of use, minibus corridors and armpits, passenger car floors, light commercial vehicle floors, vehicle luggage and cargo areas
- Environment friendly
- It is a 100% recyclable floor covering.
- Standard popflex contains recycled PVC.
- Virgin production is optional.
- Being a recyclable material, it has no chemical content and no traceability.
- It is easy to clean and suitable for mop cleaning.
- Special absorbent felt base Tx150s can be applied to all surfaces.
- Due to its compact felt-based structure, it fits on the floor easily. It is applied to the entire surface by applying water-based adhesive.

- Ekonomik Baskılı Araç İçi Yer Kaplamasıdır.
- Hafif insan trafikli alanlarında kullanılabilir.
- Kompakt ve keçe ilaveli yapıya sahip ekonomik araç içi zemin kaplamasıdır.
- Tekstil arka yüzeyi ile konforlu bir basma deneyimi sağlar.
- Alternatiflerine göre daha ekonomiktir ve fiyat avantajı sağlar.
- Kullanım alanları, minibus koridor ve koltuk altları, binek araç zeminleri, hafif ticari araç zeminleri, araç bagaj ve kargo alanlar.
- Çevre Dostudur.
- %100 geri dönüştürülebilir bir zemin kaplamasıdır.
- Standart popflex, geri dönüştürülmüş PVC içerir.
- Virgin üretimi opsiyoneldir.
- Geri dönüşümlü bir malzeme olmasından dolayı, kimyasal içerik ve izlenebilirliği yoktur.
- Moplu temizliğe uygun kolay temizlenebilir.
- Özel emici keçe tabanı Tx150s tüm yüzeylere uygulanabilir.
- Keçe tabanlı kompakt yapısı sayesinde zemine kolayca oturur. Tüm yüzeye su bazlı yapıştırıcı sürülerek uygulanır.

- Экономическое печатное напольное покрытие для салона автомобиля.
- Применяется на поверхностях в местах наименее используемых людьми.
- Это экономичное напольное покрытие для автомобильного салона с компактной войлочной структурой.
- Благодаря задней поверхности на текстильной структуре обеспечивает приятную фактуру.
- Является более экономичным в цене по сравнению с альтернативами.
- Зоны применения: коридоры и полы под сидениями мини автобусов, полы легковых автомобилей, полы легких коммерческих автомобилей, багажные и грузовые помещения транспортных средств
- Пригодно для переработки
- Это на 100% перерабатываемое напольное покрытие.
- Стандартный Popflex содержит переработанный ПВХ.
- Изготовка из первичного сырья является опциональным вариантом.
- Содержит экологически чистое, перерабатываемое сырье.
- Поскольку это перерабатываемый материал, он не содержит химических веществ и не подлежит прослеживаемости.
- Легко чистится и подходит для очищения тряпкой.
- Подходит для применения на всех поверхностях благодаря специальной абсорбирующей войлочной основе Tx150s.
- Компактная войлочная поверхность основы способствует легкой укладке покрытия. Применяется посредством нанесения клея на водной основе на всю поверхность покрытия.



## Layer Diagrams



## Katman Şemaları



## Диаграммы слоев

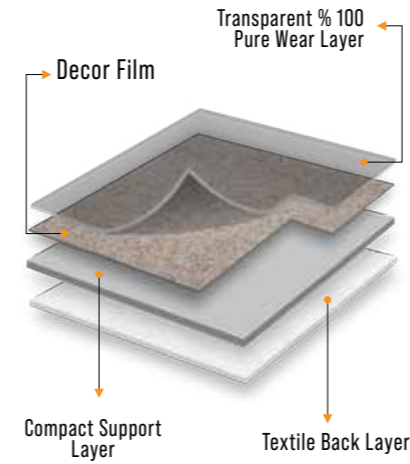

"Some products may use a different product architecture than the illustration above."



"Kimi ürünlerde, yukarıdaki gösterimden farklı ürün mimarisi kullanılabilir."



"Некоторые продукты могут использовать архитектуру продукта, отличную от той, что показана на рисунке выше."



RECYLED PVC: YES

## TECHNICAL DATA SHEET

Product Group: POPFLEX EXTRA - 1.40 mm

## TECHNICAL PROPERTIES

SPECIFICATION	STANDARD	PRODUCT
Total Thickness	EN ISO 24346	1.40 mm (min:-0.10 mm max: 0.13 mm)
Wear Layer Thickness	EN ISO 24340	0.10 mm (max:+%13 min: -%10)
Total Weight	EN ISO 23997	1375 g/m <sup>2</sup> (max:+%13 min: -%10)
Roll Width	EN ISO 24341	Max: 2 m
Roll Length	EN ISO 24341	Max: 30 m
PERFORMANCE		
Back Layer		TX150S
Dimensional Stability	EN ISO 23999	≤%0.4
Flexibility	EN ISO 24344	No Crack
Tensile Strength Crosswise	EN ISO 527	Min: 3 N/mm <sup>2</sup>
Tensile Strength Lengthwise	EN ISO 527	Min: 3 N/mm <sup>2</sup>

In case, you otherwise specify, standard PopFlex Extra products are produced with recycled PVC ingredients which the chemical history is not certified and is accepted as unknown. The chemical structure, ingredients, and chemical behaviors, including fire behavior, cannot be warranted

and are not declarable because of this recycled PVC content. However, is an optional variant and is produced with only virgin

raw material ingredients, and thus its chemical structure and chemical behaviors, including fire behavior, is totally declarable. Please kindly contact your supplier for further information.

\* Sipariş geçmeden önce, lütfen güncel TDS verilerini talep edin.

\* Before placing an order, please request up-to-date TDS data.

Recycled PVC Content	✓	✗
<b>CE</b>	✗	✓
Wear Group	Group T	Group T
Binder Content	Type 1	Type 1
Abrasion Resistance	✓	✓
100% Recyclable	✓	✓
Flexibility	✓	✓
Easy to Clean	✓	✓
Chemical Structure Declaration	✗	✓
Burning Behavior Declaration	✗	✓
Price	\$	\$\$

# PopFlex

Extra

Economic Printed Transport  
Floor Coverings

Ekonomik Araç İçi Baskılı  
Zemin Kaplamaları

Экономичный печатный транспорт  
напольные покрытия

## COSMO ( 340 )

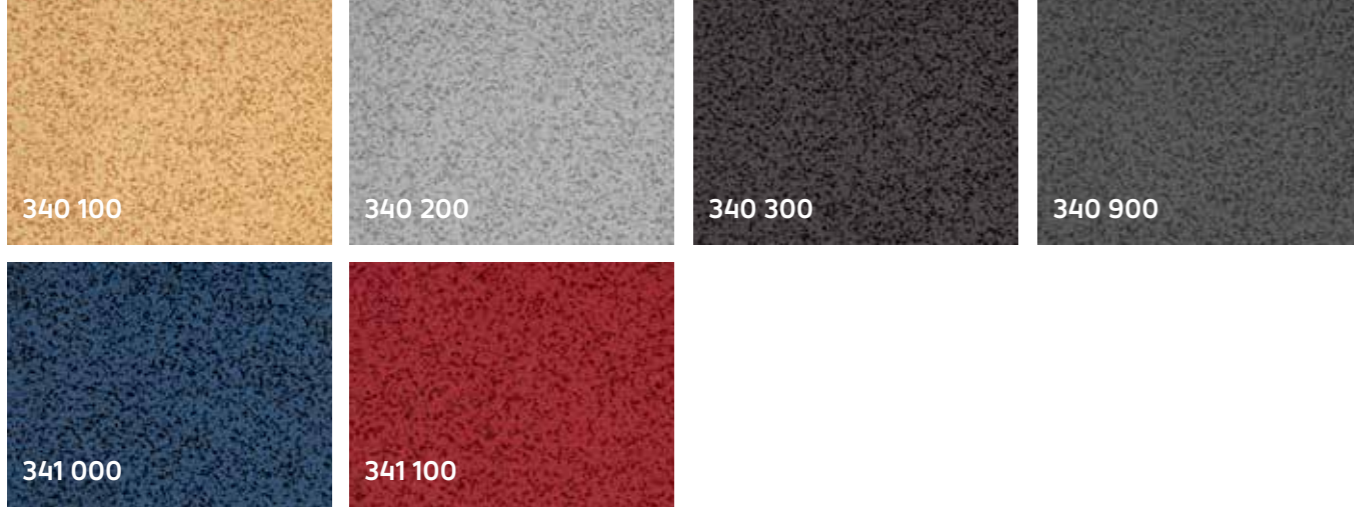

## SPECTRUM

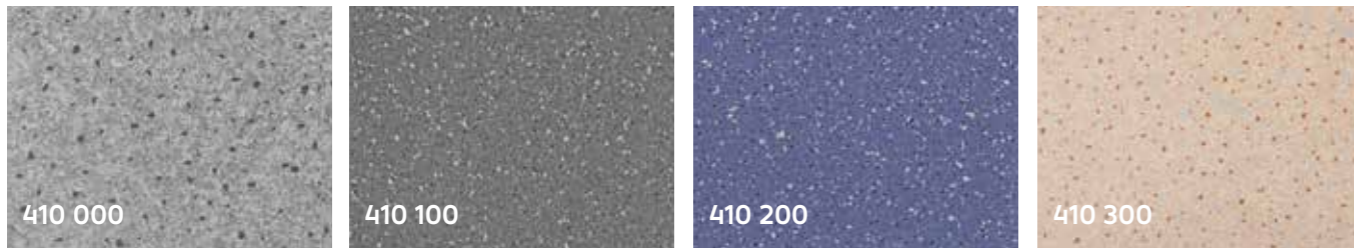

PROKOP

Professional  
Floor Coverings

Profesyonel  
Zemin Kaplamaları

Профессиональные  
напольные изделия

PROKOP



\*\* Real products may differ from above images. Please kindly note to ask for real products samples before confirming your order.

\*\* Gerçek ürünler yukarıdaki resimlerden farklı olabilir. Lütfen siparişinizi vermeden önce gerçek ürün numunelerini istemeyi unutmayın.

\*\* Реальные продукты могут отличаться от изображений выше. Пожалуйста, обратите внимание, чтобы запросить образцы реальной продукции перед подтверждением вашего заказа.

net  
FLOOR COVERINGS

www.netfloor.com.tr



## Professional Floor Coverings



## Profesyonel Zemin Kaplamaları



## Профессиональные напольные изделия



• Is our product group including calendered resilient sheets of various thermoplastics.

• Includes our products serving various industries by their specialised chemical and dimensional properties.

• Includes our products customised for our custom-er and related industry project.

• PVC based heelpads and footrests that can be laminated to carpet by frequency welding.

• TPE based coverings having maximum friction values for anti-slippery purposes.

• Indoor PVC vehicle sheets convenient for thermo-forming.

• Railway car PVC floor coverings for light railway transportation.

• PVC floor coverings for intercity and city train railway cars.

### Such as

• PVC Coverings with increased electrical insula-tion that can be used in front of electric panels.

• Products with increased or reduced surface electrical conductivity.

• PVC and EVA based sheets for better sound insulation.

• TPO sheets.

• PVC sheets for water insulation and various other products.

• Includes products in 50cm -200cm widths that is determined according to related product character-istics and production quantities.

• Includes products in 0.10mm -4 mm thicknesses that is determined according to related product characteristics and production quantities.

• Please contact us for your calendered thermoplas-tic production requirements.

• Muhtelif termoplastiklerden mamül esnek nitelikte kalenderlenmiş levhalarımızı toparlayan ürün grubumuzdur.

• Özelleşmiş kimyasal ve boyutsal nitelikleriyle birçok endüstriye hizmet veren ürünlerimizi içerir.

• Müşterimize ve ilgili endüstri projesine özelleşmiş ürünlerimizi içerir.

### Bunlar arasında

• Frekans kaynağı ile haliya laminasyonu yapıla-bilen PVC topukluklar.

• Kaymazlık amaçlarıyla sürtünme değerleri maksimize edilen TPE kaplamalar.

• Termoformlanabilen araç içi PVC kaplamaları.

• Hafif raylı taşımaya uygun PVC vagon zemin kaplamaları.

• Şehirlerarası ve banliyö tren vagonları için PVC zemin kaplamaları.

• Elektrik panolarının önlerinde kullanılabilen elektrik yalıtımlı güçlendirilmiş PVC kaplamalar.

• Yüzey elektrik geçirgenliği azaltılmış veya artırılmış ürünler.

• Ses izolasyonuna dönük PVC veya EVA levhalar.

• TPO levhalar.

• Su izolasyonuna dönük PVC levhalar ve farklı ürünlerimiz yer almaktadır.

• İlgili ürün özellik ve üretim miktarlarına göre 50cm

• 200 cm genişliğinde ürünleri içerir.

• İlgili ürün özellik ve üretim miktarlarına göre 0.10mm - 4 mm kalınlığında ürünleri içerir.

• Kalenderlenmiş termoplastik üretim ihtiyaçlarınız için lütfen bizi arayınız.

• Группа продукции, включающая каландрированные гибкие пластины, изготовленные из различных видов термопластмассы.

• Включает продукцию, обслуживающие многие отрасли промышленности благодаря своим химическим и размерным свойствам.

• Содержит продукцию, разработанную индивидуально для клиента и отрасли промышленности.

### В том числе

• Группа продукции из ПВХ, ламинируемая на ковровых покрытиях посредством частотной сварки.

• Покрытия TPE, отличающиеся высокой устойчивостью к скольжению и доводящих до максимума показатели трения.

• Покрытия ПВХ для внутренних частей транспортных средств, подвергающиеся термообработке.

• Покрытия из ПВХ для вагонов, пригодных для легких рельсовых транспортных средств.

• Покрытия из ПВХ для вагонов поездов междугородных и внутригородских поездов.

• Покрытия из ПВХ с повышенной электроизоляцией для применения перед электрическими щитами.

• Изделия с увеличенной или сниженной электрической проводимостью поверхности.

• Плиты из ПВХ или EVA для звукоизоляции.

• Пластины TPO.

• Пластины из ПВХ для гидроизоляции. А также другие изделия.

• Включает продукцию шириной 50 см-200 см в зависимости от характеристик и объема производства.

• Включает продукцию толщиной 0.10мм-4 мм в зависимости от характеристик и объема производства.

• При необходимости в каландрированном термопластиковом производстве пожалуйста обращайтесь к нам.

## Özellikler

## Specifications

## Характеристики

### DANCE FLOORING

GLASS FIBER TISSUE : OK

TECHNICAL DATA SHEET		
Product Group: DANCE FLOORING-1.35 mm-0.55mm		
TECHNICAL PROPERTIES		
SPECIFICATION	STANDARD	PRODUCT
Total thickness	EN ISO 24346	1.35mm (min:-0.10mm max: 0.13mm)
Total weight	EN ISO 23997	1870 g/m2 (max:+%13 min: -%10)
Wear layer thickness	EN ISO 24340	0.55mm (max:+%13 min: -%10)
Roll width	EN ISO 24341	150 cm
Roll Length	EN ISO 24341	12m
PERFORMANCE		
Flexibility	EN ISO 24344	No Crack
Hardness		92 SHA ±2

### PVC SKIN LAYERS FOR FLOORING & TRIM APPLICATIONS

TECHNICAL DATA SHEET		
Product Group: PVC Skin Layers for Flooring & Side Applications		
TECHNICAL PROPERTIES		
SPECIFICATION	STANDARD	PRODUCT
Total thickness	EN ISO 24346	0.63 ± 0.05
Total weight	EN ISO 23997	750 (-%13 / +%10)
Roll width	EN ISO 24341	190 cm
Roll length	EN ISO 24341	180 mt
PERFORMANCE		
Hardness		85 ±5 SHA
Tensile Strength Crosswise	EN ISO 527	Ort: 12 N/mm²
Elongation at break Crosswise	EN ISO 527	Ort: 100%
Tensile strength Lengthwise	EN ISO 527	Ort: 13 N/mm²
Elongation at break Lengthwise	EN ISO 527	Ort: 90%
Residual indentation	EN ISO 24343-1	≤0.1 mm

### THERMOFORMABLE PVC SHEETS FOR VEHICLES

TECHNICAL DATA SHEET		
Product Group: Thermoformable PVC Sheets for Vehicles		
TECHNICAL PROPERTIES		
SPECIFICATION	STANDARD	PRODUCT
Total thickness	EN ISO 24346	1.5mm (min:-0.10 max:+0.13)
Total weight	EN ISO 23997	2450 g/m2 (max:+%10 min: -%10)
Plate width	EN ISO 24341	157 cm
Plate length	EN ISO 24341	182 cm
PERFORMANCE		
Horizontal burning rate	ECE R 118 95/28 EC	<100 mm/dk
Flexibility	EN ISO 24344	No Crack
Hardness	DIN 55505	90±5
Tensile Strength (Crosswise)	TS EN ISO 527-1-2-3	Min: 5 N/mm²
Tensile Strength (length)	TS EN ISO 527-1-2-3	Min: 5 N/mm²
Odour		There will be no uncomfortable smell

### PVC/EVA BASED HEAVY LAYERS AS SOUND & VIBRATION BARRIERS

TECHNICAL DATA SHEET		
Product Group: PVC/EVA Based Heavy Layers as Sound & Vibration Barriers		
TECHNICAL PROPERTIES		
SPECIFICATION	STANDARD	PRODUCT
Total thickness	EN ISO 24346	3 mm (min:-0.10 mm max: 0.13 mm)
Total weight	EN ISO 23997	5000 g/m² (max:+%13 min: -%10)
Roll width	EN ISO 24341	100 cm
Colour		Black

### PVC FILM LAYERS FOR INDUSTRIAL APPLICATIONS

PURGUARD : YES

TECHNICAL DATA SHEET		
Product Group: PVC Film Layers for Industrial Applications		
TECHNICAL PROPERTIES		
SPECIFICATION	STANDARD	PRODUCT
Total thickness	In house	0.15 mm (min:-0.03 mm max: 0.03 mm)
Total weight	EN ISO 23997	220 g/m2 (max:+%13 min: -%10)
Colour		Siyah/Black
PERFORMANCE		
Flexibility	EN ISO 24344	No Crack
Gloss	*50	Max : 2

### TPE SKIN LAYERS FOR INDUSTRIAL APPLICATIONS (HIGH FRICTION)

TECHNICAL DATA SHEET		
Product Group: TPE Skin Layers for Industrial Applications (High friction)		
TECHNICAL PROPERTIES		
SPECIFICATION	STANDARD	PRODUCT
Total thickness	EN ISO 24346	0.90mm (min:-0.10mm max: 0.13mm)
Total weight	EN ISO 23997	830 g/m2 (max:+%13 min: -%10)
Roll width	EN ISO 24341	Min: 50 cm
Roll length	EN ISO 24341	Min: 10 m
PERFORMANCE		
Flexibility	EN ISO 24344	No Crack
Tensile Strength Crosswise	EN ISO 527	Min: 3 N/mm²
Tensile strength Lengthwise	EN ISO 527	Min: 3 N/mm²
Hardness	ISO 7619	70±5 SHA

### TPO SKIN LAYERS FOR FLOORING APPLICATIONS

TECHNICAL DATA SHEET		
Product Group: TPO Skin Layers for Flooring Applications		
TECHNICAL PROPERTIES		
SPECIFICATION	STANDARD	PRODUCT
Total thickness	EN ISO 24346	0.90 mm (min:-0.10 mm max: 0.13 mm) / 1.50 mm (min:-0.10 mm max: 0.13 mm)
Total weight	EN ISO 23997	700 g/m² (max: +%13 min: -%10) / 1750 g/m² (max: +%13 min: -%10)
Roll width	EN ISO 24341	200 cm / 200 cm
Roll length	EN ISO 24341	25.15 m / 25.15 m
Backside		TX045 Textile / TX045 Textile
PERFORMANCE		
Flexibility	EN ISO 24344	No Crack / No Crack
Hardness	ISO 7919	80±5 / 80±5

### PVC FOOTREST SHEETS FOR CAR MATS

TECHNICAL DATA SHEET		
Product Group: PVC Footrest Sheets for Car Mats		
TECHNICAL PROPERTIES		
SPECIFICATION	STANDARD	PRODUCT
Total thickness	EN ISO 24346	1.20mm (min:-0.10mm max:+0.13) / 0.90mm (min:-0.10 max:+0.13)
Total weight	EN ISO 23997	1650 g/m² (max:+%13 min: -%10) / 1.210 g/m² (max:+%13 min: -%10) / 1050 g/m² (max:+%13 min: -%10)
Roll width	EN ISO 24341	85 cm / 85 cm / 85 cm
Roll length	EN ISO 24341	25.15 m / 25.15 m / 25.15 m
PERFORMANCE		
Horizontal burning rate	ECE R 118 94/28 EC	<100 mm/minute / <100 mm/minute / <100 mm/minute
Flexibility	EN ISO 24344	No Crack / No Crack / No Crack
Hardness	ISO 7919	90 (Q/+5) Sha / 90 (Q/+5) Sha / 90 (Q/+5) Sha
Odour		There will be no uncomfortable smell / There will be no uncomfortable smell / There will be no uncomfortable smell

\* Sipariş geçmeden önce, lütfen güncel TDS verilerini talep edin.  
\* Before placing an order, please request up-to-date TDS data.



## Frekans Kaynağı Yapılabilen Ürünler / Coverings For Frequency Welding

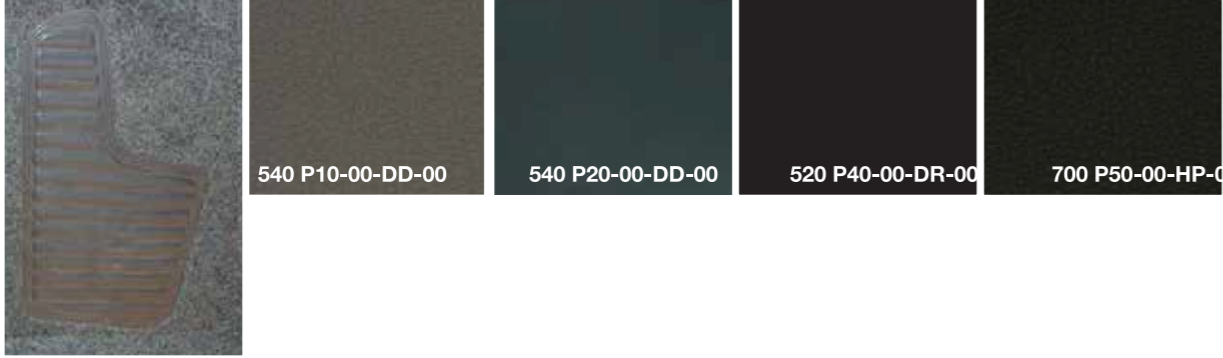

## Hafif Raylı Araç Kaplamaları / Light Rail Vehicle Floorings



## Şehirler Arası Tren Vagon Kaplamaları / Intercity Railway Car Floorings



## Kaydırmaz Kaplamalar / Anti Slip Coverings



\*\* Real products may differ from above images. Please kindly note to ask for real products samples before confirming your order.

\*\* Gerçek ürünler yukarıdaki resimlerden farklı olabilir. Lütfen siparişinizi vermeden önce gerçek ürün numunelerini istemeyi unutmayın.

\*\* Реальные продукты могут отличаться от изображений выше. Пожалуйста, обратите внимание, чтобы запросить образцы реальной продукции перед подтверждением вашего заказа.

## ÜRÜN ÇEŞİTLERİ

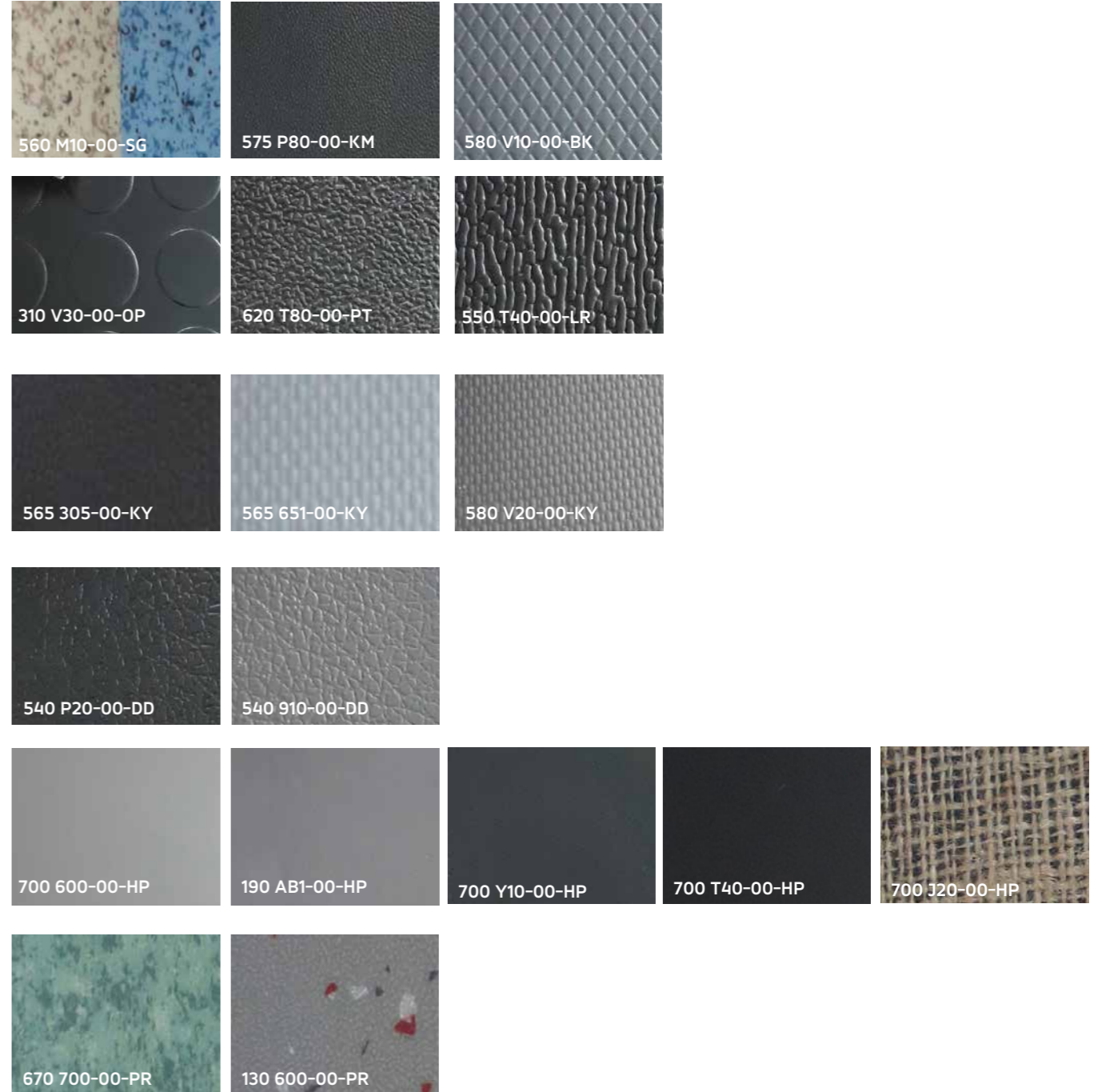

\*\* Real products may differ from above images. Please kindly note to ask for real products samples before confirming your order.

\*\* Gerçek ürünler yukarıdaki resimlerden farklı olabilir. Lütfen siparişinizi vermeden önce gerçek ürün numunelerini istemeyi unutmayın.

\*\* Реальные продукты могут отличаться от изображений выше. Пожалуйста, обратите внимание, чтобы запросить образцы реальной продукции перед подтверждением вашего заказа.



net finishing profiles

**FINISHING PROFILES**  
FOR RESILLIENT FLOOR COVERINGS



**FINISHING PROFILES**  
FOR RESILLIENT FLOOR COVERINGS

net finishing profiles

## ENJOY OUR FINISHING PROFILES

Please enjoy our finishing profiles of variable skirtings, anti-slippery details, passageways as well as welding rods in your various installations.

We present our profiles with a rich color palette that would be in line with our floor coverings.

## SKIRTING SOLUTIONS

- Decorative Skirting - Foam
- Rigid Skirting
- Soft Flexible Skirting
- Set in Skirting
- Coving Solutions
- Capping Strips
- Cove Formers

## WELDING SOLUTIONS

- Hot Welding

## RIGID SKIRTINGS FOAM BASED

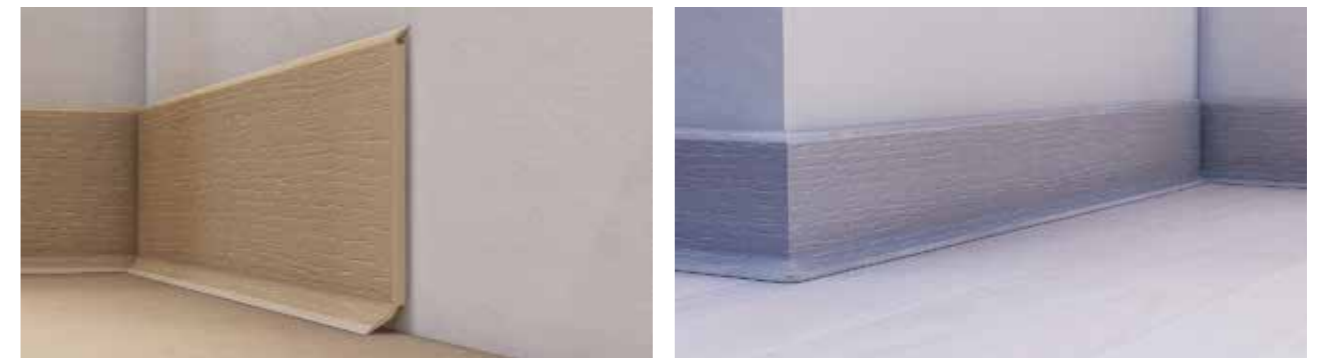
**RSFS 600**

## RSFS PLAIN COLORS

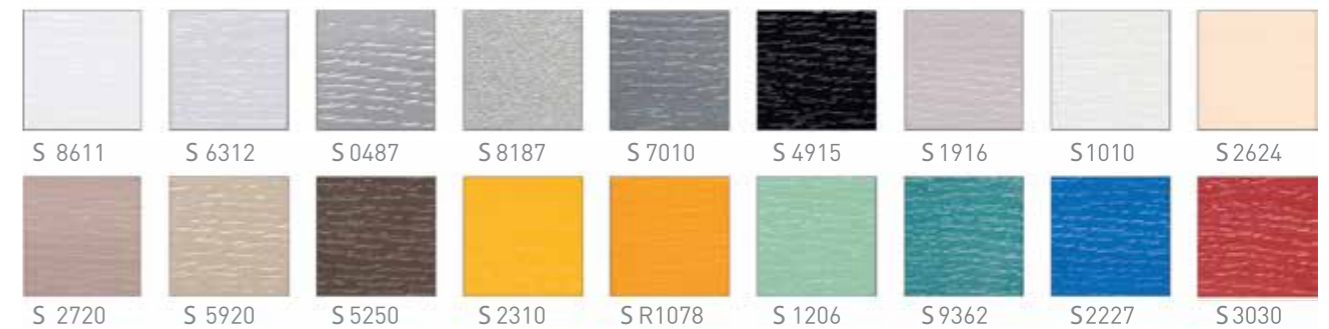

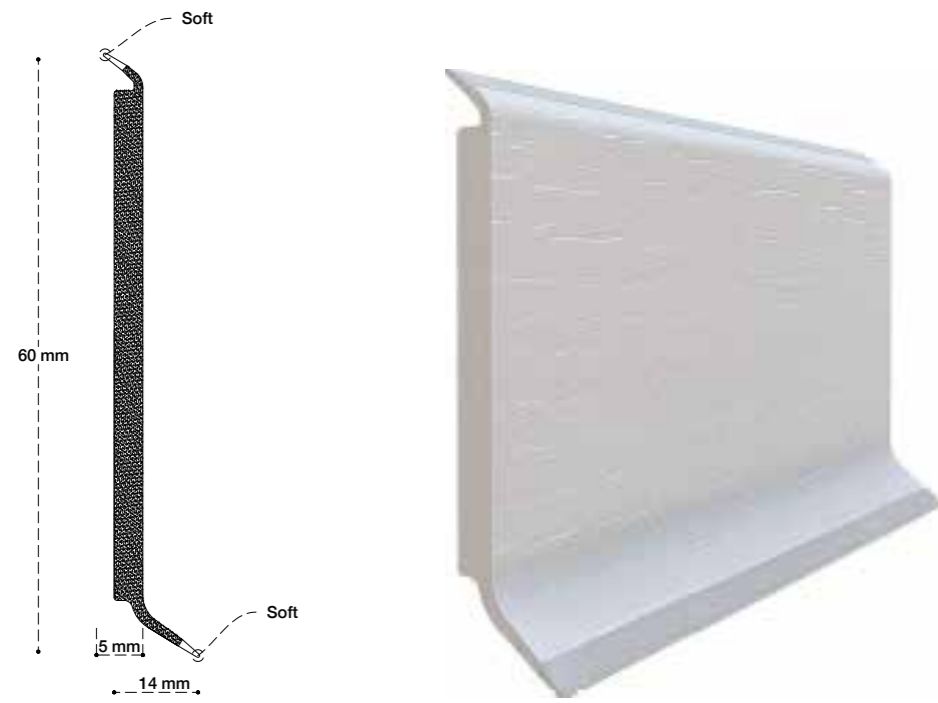

**RSFS 600**

**LOGISTIC DATA**

	Standard	Optionally
2,5 m Lenght	4 m Lenght	
100 m	100 m	
4000 m	2500 m	

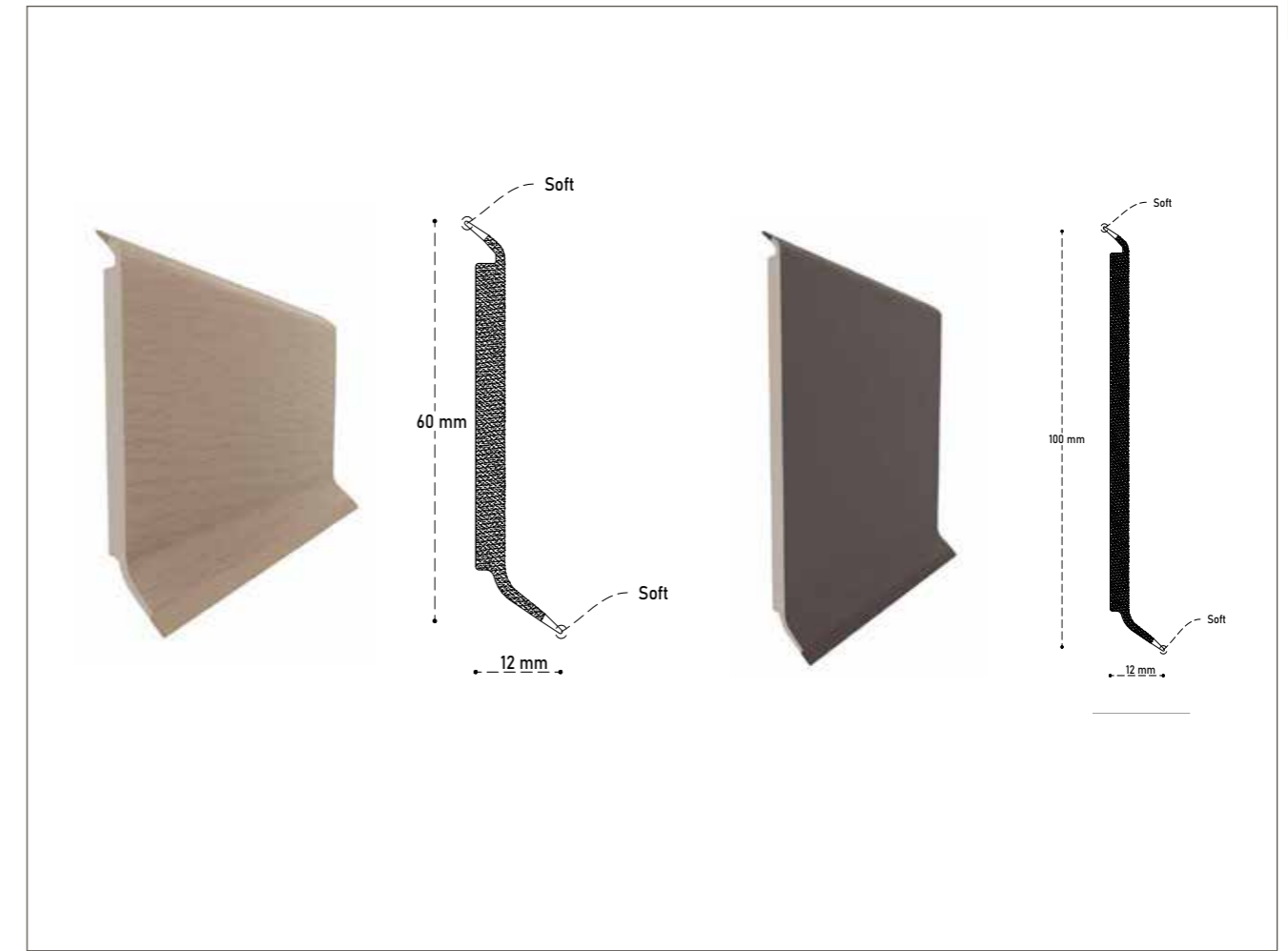

**RSFS 1000**

**LOGISTIC DATA**

	Standard	Optionally
2,5 m Lenght	4 m Lenght	
100 m	100 m	
4000 m	2500 m	

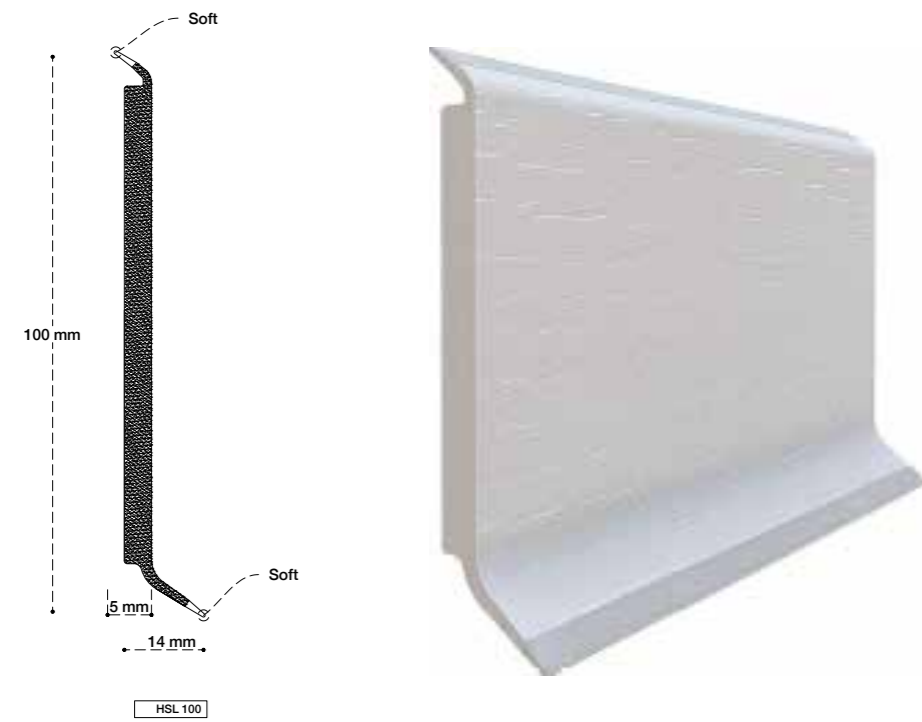

**TECHNICAL SPECIFICATIONS FOR RSFS 600**

- Our foam based decorative skirtings can be produced with different dimensions.
- Our skirting stamp machine helps you for perfect installations.
- Our foam based decorative skirtings fit to walls and floor with a perfect touch thanks to the flexible soft parts of our profiles.
- Standard lengths for RSFS 600 : 2,5 and 4 ml
- Standard box for RSFS 600 : 100mlin (total)
- Kindly note that colors in this booklet may differ from the real sample colors due to printer screen set-ups and conditions. Please ask for real samples before cokor selections.
- It is possible to customise colors for RSFS 600 range with reference to RAL color codes for nonstandard production. Please ask for customisation conditions.
- It is possible to customise skirting profile lengths for RSFS 600 for nonstandard production. Please ask for customisation conditions.

**ASSEMBLING INFORMATION**

- Just measure your skirting, sign the bending sides,
- Bend your profile according to the right angle of the corner on the wall
- Punch the signed sides according to your bending direction,

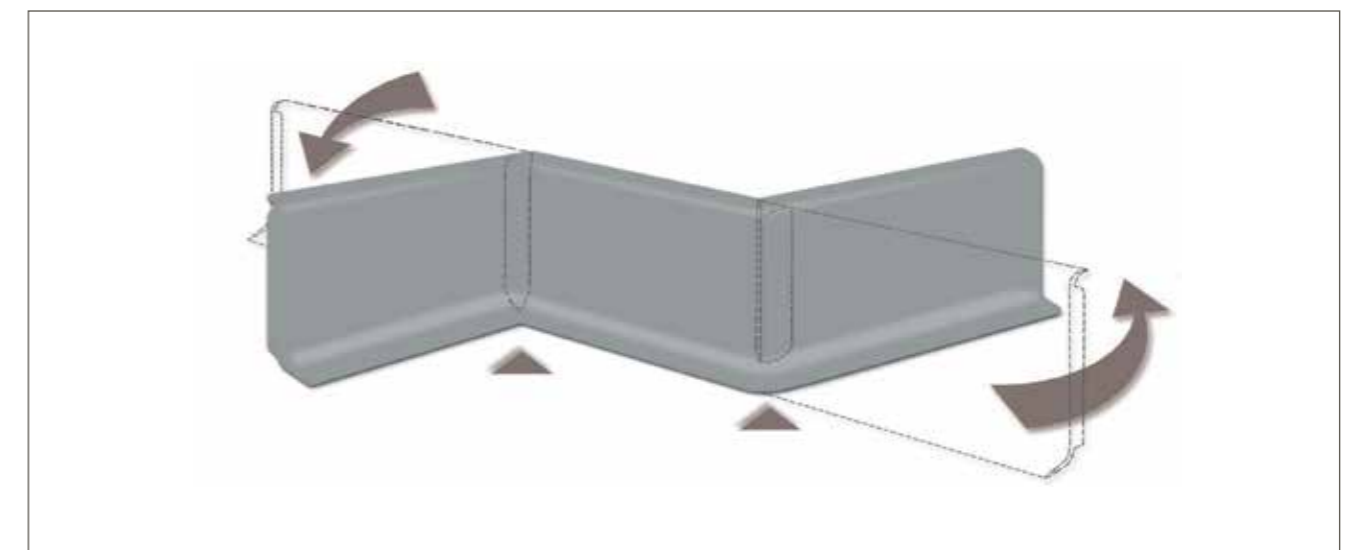



SPPD SERIES COLORS

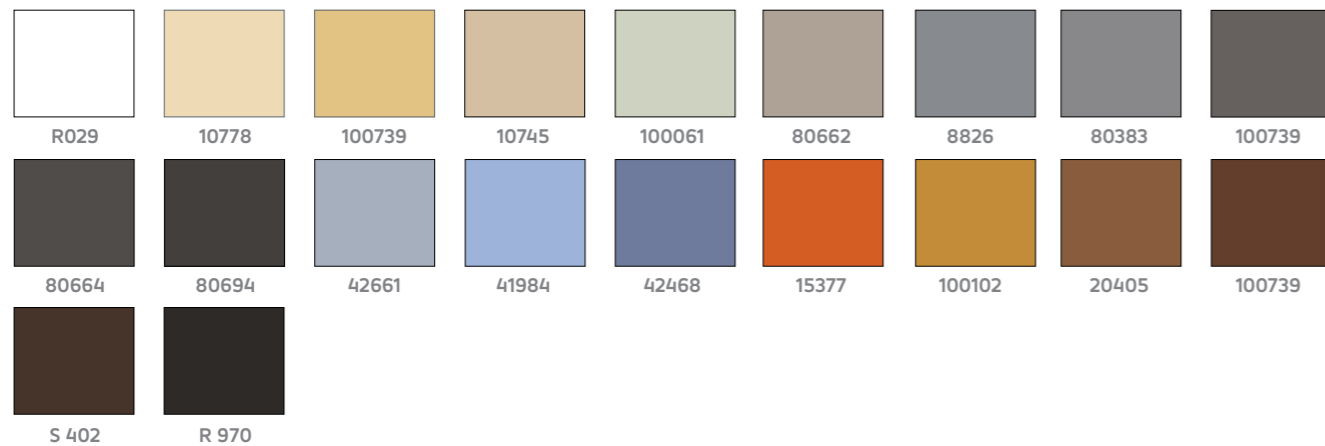

KINDLY NOTE THAT COLORS IN THE BOOKLET MAY DIFFER FROM THE REAL SAMPLE COLORS DUE TO PRINTER SCREENSET-UPS AND CONDITIONS PLEASE ASK FOR REAL SAMPLES BEFORE COLOR SELECTIONS



TECHNICAL SPECIFICATIONS FOR SPPD SERIES

- Our SPPD profile is a single solution for a perfect pool-type installation of vinyl
- Our SPPD profiles are specially developed for vinyl installations in hospitals and waterproofing needs
- Standard Package: 50 ml/box
- Hardness: 85-90 Shore A (90-95 Shore A is optional)
- Our SPPD profile is a combination of a cap in the desired color (in harmony with the installed vinyl) and a back part in standard black color.
- It is possible to customise colors for SPPD range with reference to RAL color codes for nonstandard production. Please ask for customisation conditions.
- Kindly note that colors in this booklet may differ from the real sample colors due to printer screen set-ups and conditions. Please ask for real samples before color selections.

FLEXIBLE PLINTH PROFILES (DOUBLE COLOR)

FLEXIBLE PLINTH PROFILES (DOUBLE COLOR)

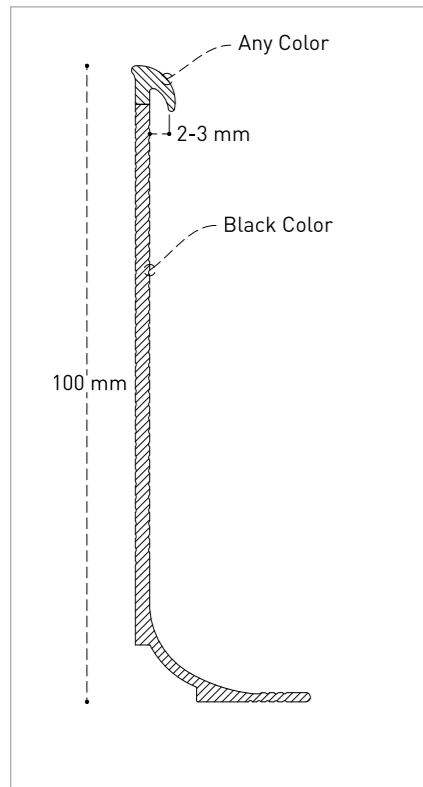

**SPPD 040**

**LOGISTIC DATA**  
Standard

- 25 m /Roll
- 25 m
- 1400 m

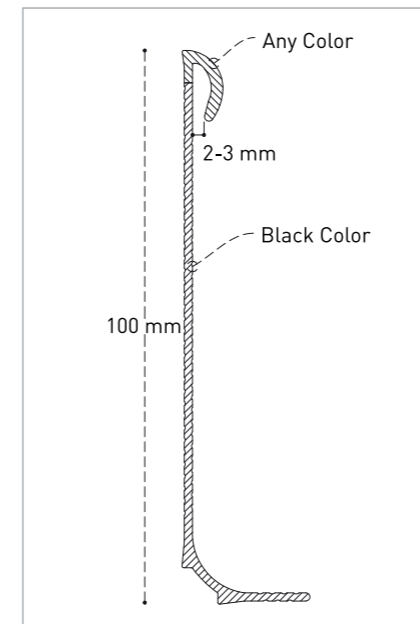

**SPPD 010 / 2**

**LOGISTIC DATA**  
Standard

- 25 m /Roll
- 25 m
- 1400 m

SINGLE COLOR FLEXIBLE PLINTH PROFILES

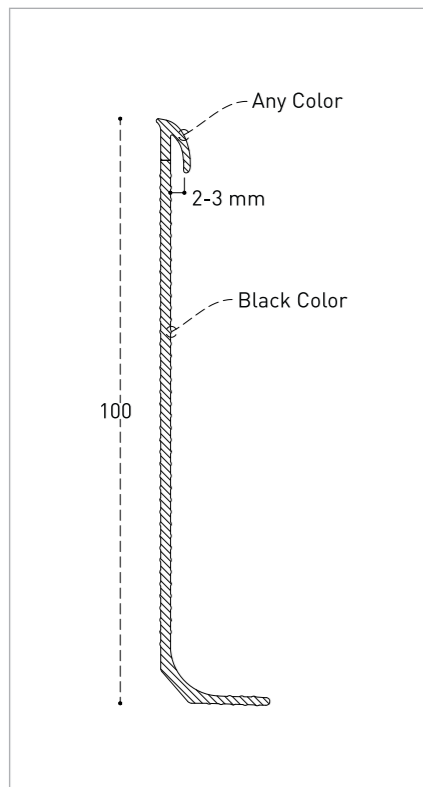

**SPPD 040 E**

**LOGISTIC DATA**  
Standard

- 25 m /Roll
- 25 m
- 1400 m

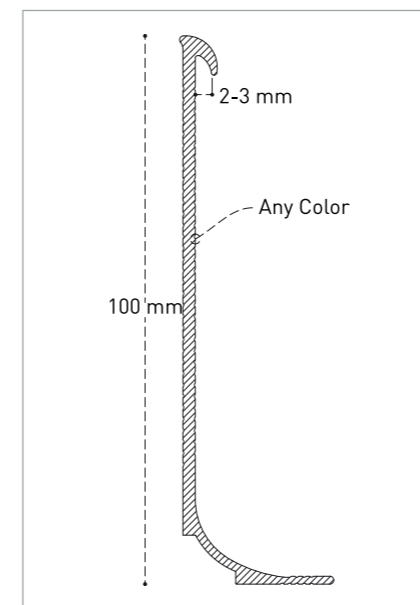

**SPPS 040 (SINGLE COLOR)**

**LOGISTIC DATA**  
Standard

- 25 m /Roll
- 25 m
- 1400 m



➤ TECHNICAL SPECIFICATIONS FOR SCPS SERIES

- Our SCPS range profiles are specially developed for residential vinyl installations as well as commercial type vinyl installations.
- It is possible to customise colors for SCPS range with reference to RAL color codes for nonstandard production. Please ask for customisation conditions.
- Standard Package: 25 ml/box
- Kindly note that colors in this booklet may differ from the real sample colors due to printer set-ups and conditions. Please ask for real samples before color selections.

SCPS SERIES COLORS

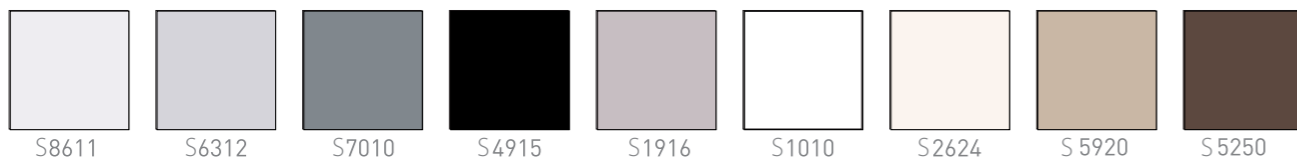

KINDLY NOTE THAT COLORS IN THE BOOKLET MAY DIFFER FROM THE REAL SAMPLE COLORS DUE TO PRINTER SCREEN SET-UPS AND CONDITIONS PLEASE ASK FOR REAL SAMPLES BEFORE COLOR SELECTIONS

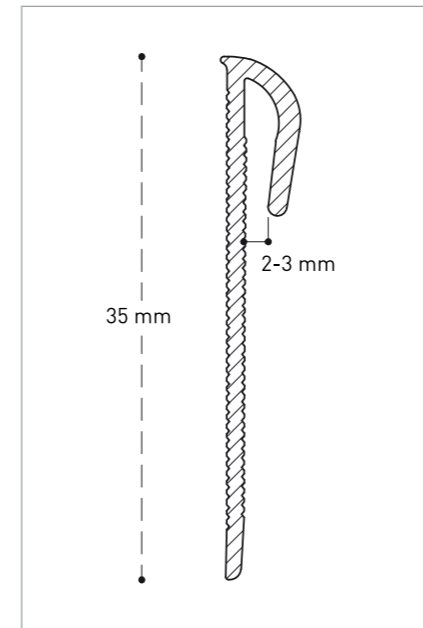

SCPS 020

➤ LOGISTIC DATA

Standard	Optionally
25 m / Roll	4.00 m / Length
100 m	100 m
4000 m	3000 m

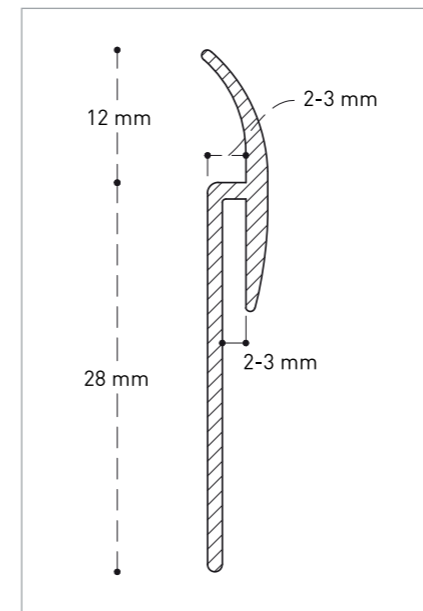

SCPS 300

➤ LOGISTIC DATA

Standard	Optionally
25 m / Roll	4.00 m / Length
100 m	100 m
4000 m	3000 m

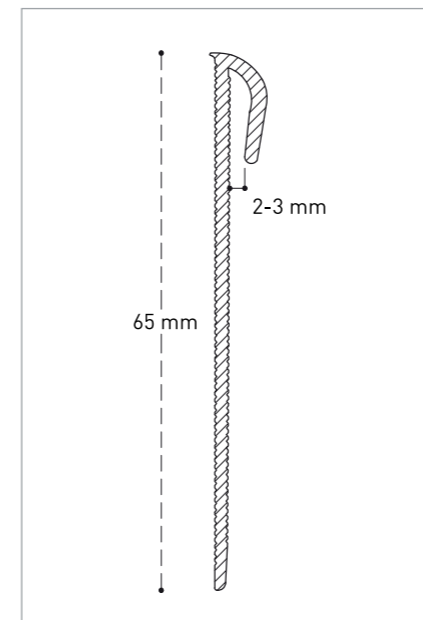

SCPS 650

➤ LOGISTIC DATA

Standard	Optionally
25 m / Roll	4.00 m / Length
50 m	100 m
2400 m	3000 m

**RCPS 300**

▶ **LOGISTIC DATA**

	Standard	Optionally
	2,5 m /Roll	4.00 m /Length
	100 m	100 m
	4000 m	3000 m

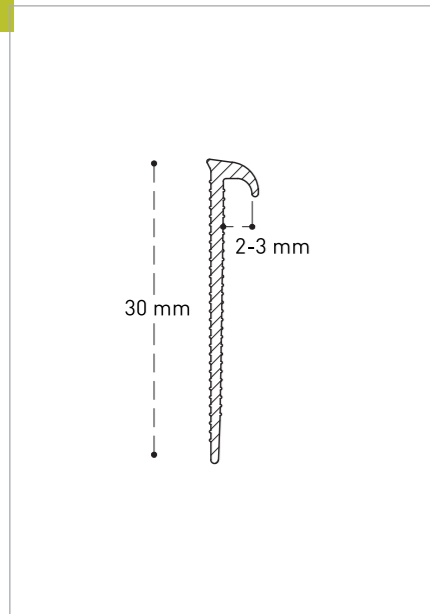

▶ **TECHNICAL SPECIFICATIONS FOR SFPS SERIES**

- ▶ SFPS Series are produced in different sizes
- ▶ SFPS Series can be used in commercial and residential Flooring
- ▶ Available in black color only
- ▶ Length; 25 mtr. for standart production



**SFPS SERIES COLOR**



S4915

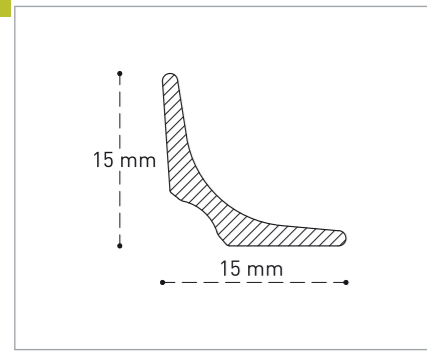

**SFPS 150**

▶ LOGISTIC DATA

Standard	Optionally
25 m /Roll	2,50 m /Length
100 m	100 m
3200 m	3500 m

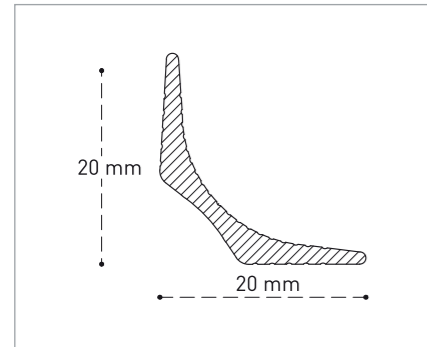

**SFPS 200**

▶ LOGISTIC DATA

Standard	Optionally
25 m /Roll	2,50 m /Length
100 m	100 m
2800 m	3500 m

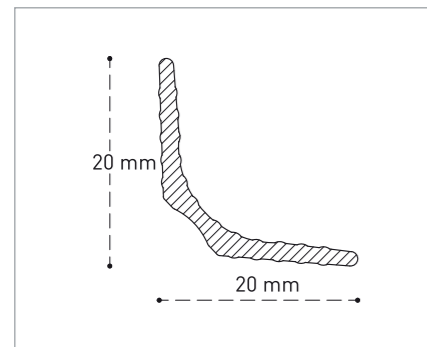

**SFPS 200 E**

▶ LOGISTIC DATA

Standard	Optionally
25 m /Roll	2,50 m /Length
100 m	100 m
2800 m	3500 m

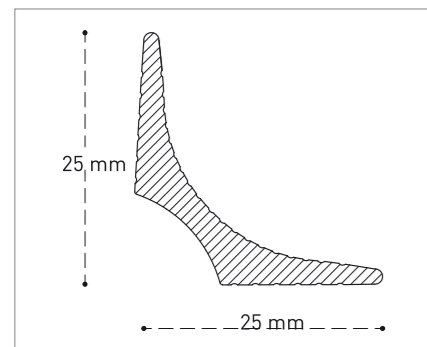

**SFPS 250**

▶ LOGISTIC DATA

Standard	Optionally
25 m /Roll	2,50 m /Length
100 m	100 m
2800 m	3500 m

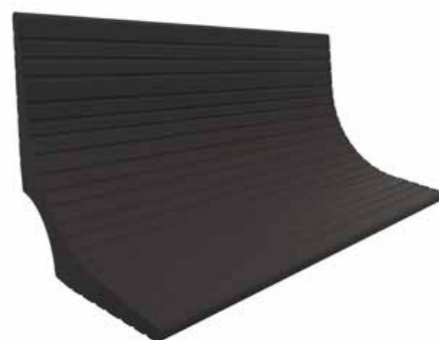
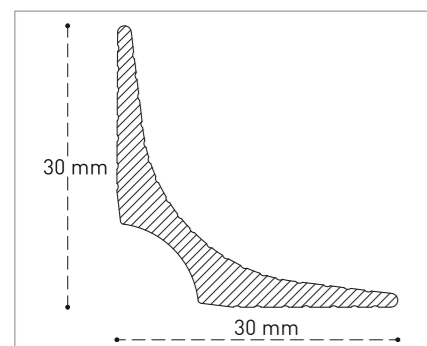

**SFPS 300**

▶ LOGISTIC DATA

Standard	Optionally
25 m /Roll	2,50 m /Length
100 m	100 m
2800 m	3500 m



▶ TECHNICAL SPECIFICATIONS FOR SSPS SERIES

- ▶ SSPS Series are produced in different sizes
- ▶ SSPS Series can be used with commercial and residential Floorings
- ▶ Colors on demand for series of SSPS
- ▶ Length; 50 mtr. for standart production



SSPS SERIES COLORS

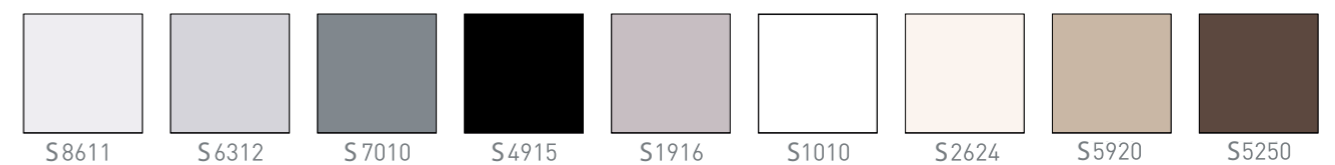

KINDLY NOTE THAT COLORS IN THE BOOKLET MAY DIFFER FROM THE REAL SAMPLE COLORS DUE TO PRINTER SCREEN SET-UPS AND CONDITIONS PLEASE ASK FOR REAL SAMPLES BEFORE COLOR SELECTIONS

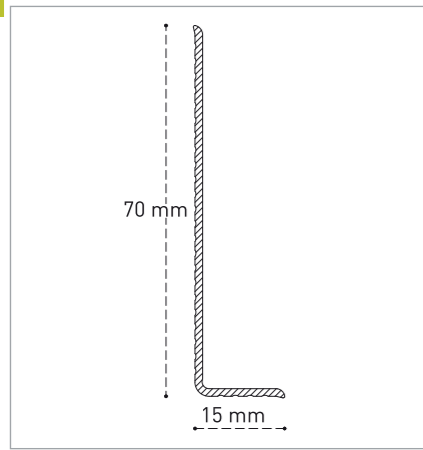

**SSPS 70150**

▶ LOGISTIC DATA

Standard	
	50 m / Roll
	150 m
	3000 m

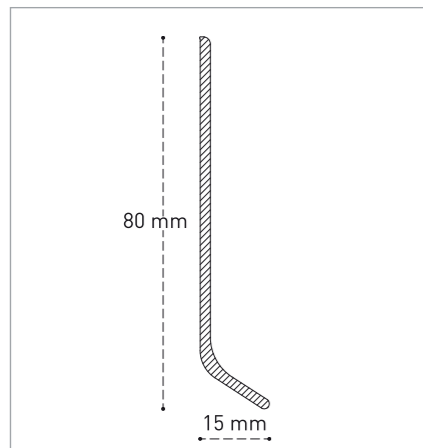

**SSPS 800**

▶ LOGISTIC DATA

Standard	Optionally
50 m / Roll	4 m / Length
100 m	100 m
2800 m	3000 m

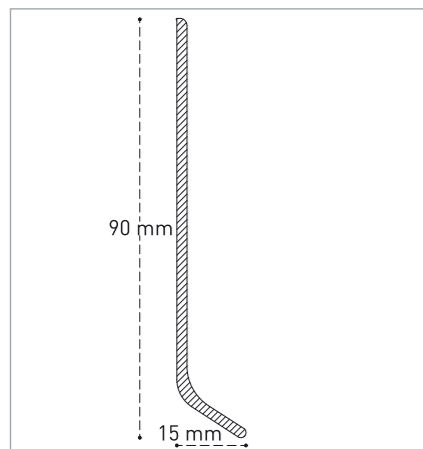

**SSPS 900**

▶ LOGISTIC DATA

Standard	Optionally
50 m / Roll	4 m / Length
100 m	100 m
2800 m	3000 m

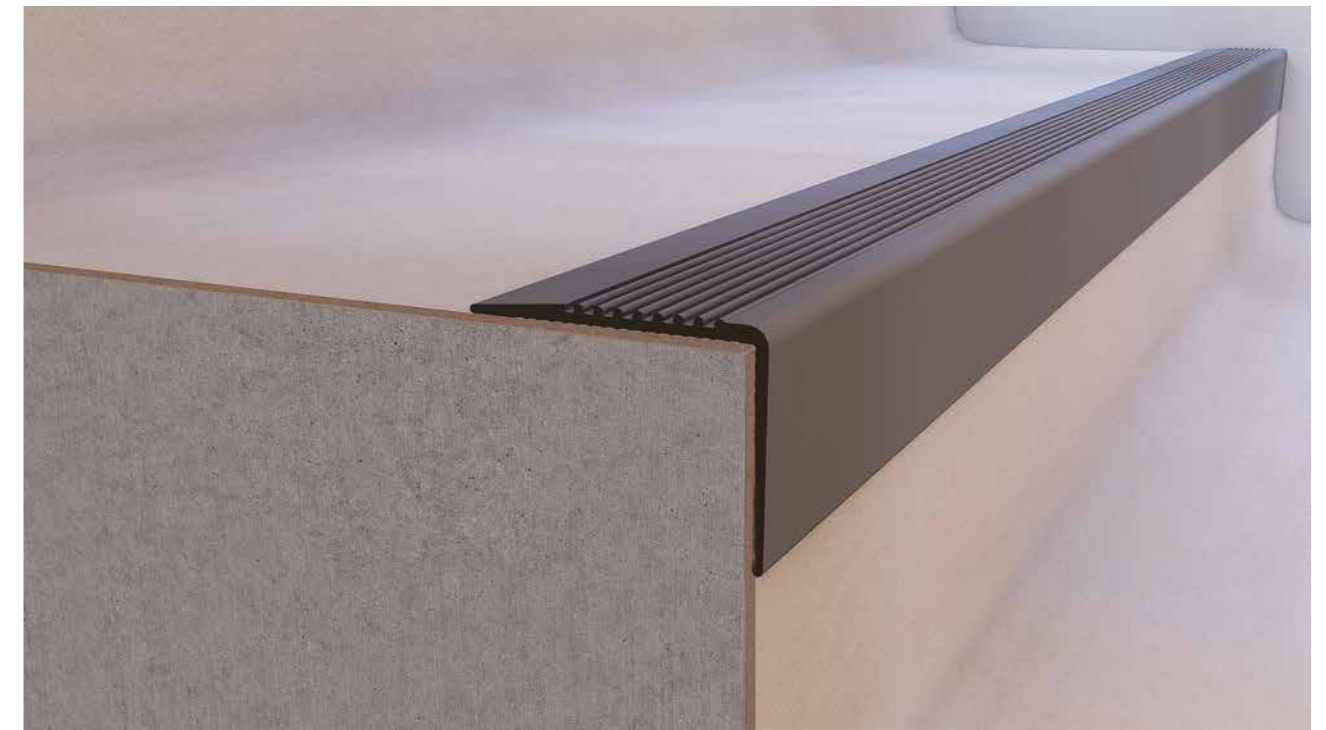

▶ TECHNICAL SPECIFICATIONS FOR SEPS SERIES

- ▶ SEPS Series are produced in different sizes
- ▶ SEPS Series can be used with commercial and residential floorings
- ▶ Hardness Value Shore-A 85-90 / Optional Shore-A95
- ▶ Colors on demand for series of SEPS
- ▶ Length; 2,5 - 3 mtr. for standart production (Desired custom sizes-special color production)

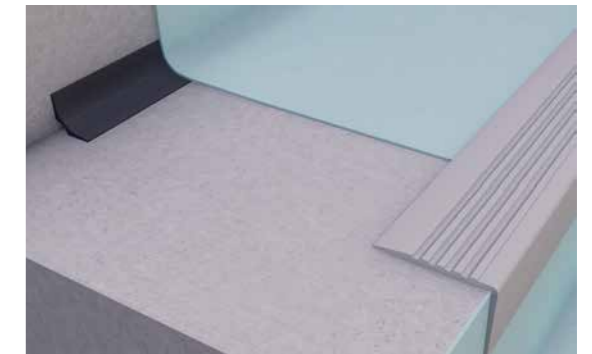

**SEPS SERIES COLORS**

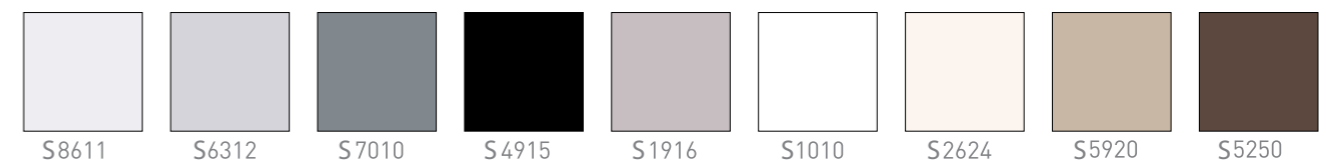

KINDLY NOTE THAT COLORS IN THE BOOKLET MAY DIFFER FROM THE REAL SAMPLE COLORS DUE TO PRINTER SCREEN SET-UPS AND CONDITIONS PLEASE ASK FOR REAL SAMPLES BEFORE COLOR SELECTIONS

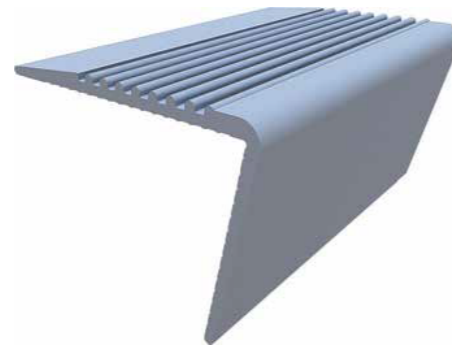
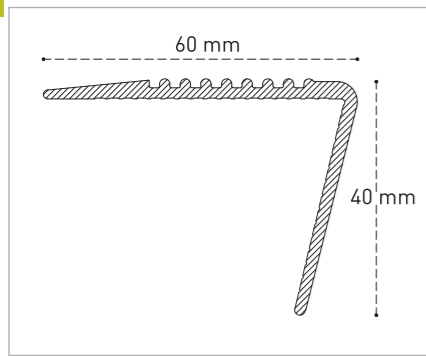

**SEPS010**

LOGISTIC DATA

Standard	Optionally
2,50 m /Roll	4 m /Length
50 m	80 m
1650 m	2400 m

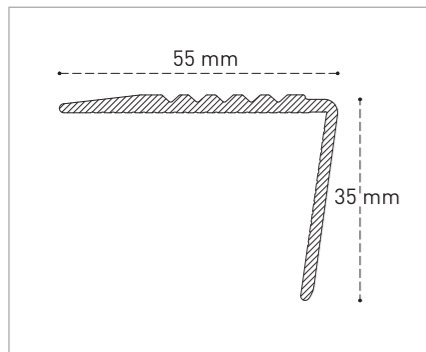

**SEPS020**

LOGISTIC DATA

Standard	Optionally
2,50 m /Roll	4 m /Length
50 m	80 m
1650 m	2400 m

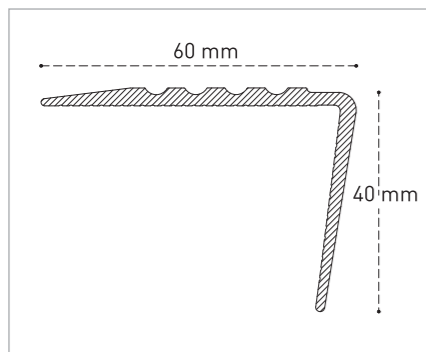

**SEPS030**

LOGISTIC DATA

Standard	Optionally
2,50 m /Roll	4 m /Length
50 m	80 m
1650 m	2400 m

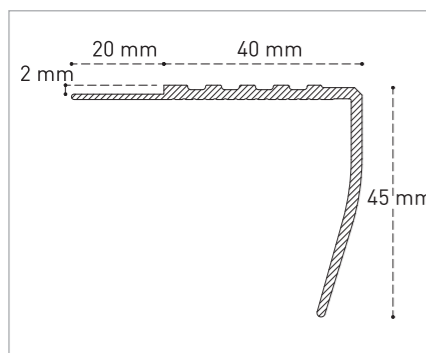

**SEPS040**

LOGISTIC DATA

Standard	Optionally
2,50 m /Roll	4 m /Length
50 m	80 m
1650 m	2400 m



TECHNICAL SPECIFICATIONS FOR SRPS SERIES

- This is used for all types of PVC floors, with required seam strengths
- Ensure a complete watertight seal
- Specifications of raw material of SRPS Series;
- Colors on demand
- Package : See below chart
- The welding rod is placed between two rolls of floor coverings. When heated, it melts and fills the entire space to ensure complete watertight seal.

Product Code	Meter/Roll
SRPS 050 / SRPS 055	100
SRPS 070 / SRPS 075	50
SRPS 065	100
SRPS T7S	50
SRPS AB2	50
SRPS AB3	50

STANDARD

**SRPS 050**



**SRPS 070**

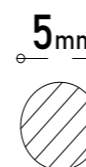

PROFILES FOR VEHICLE PRODUCERS

**SRPS 05S**



**SRPS 06S**

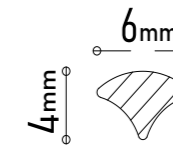

**SRPS 07S**



**SRPS T7S**

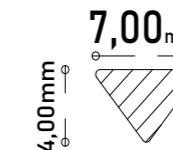

**SRPS AB2**

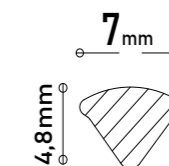

**SRPS AB3**

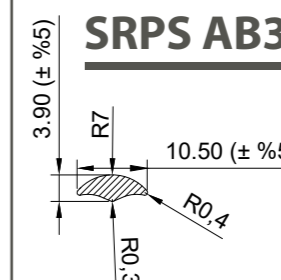

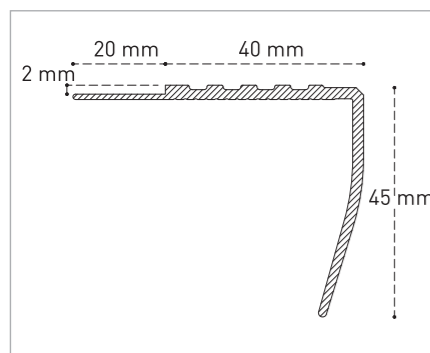
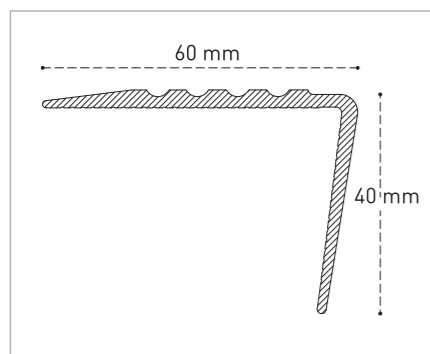
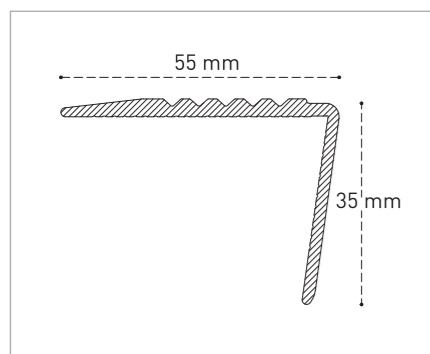
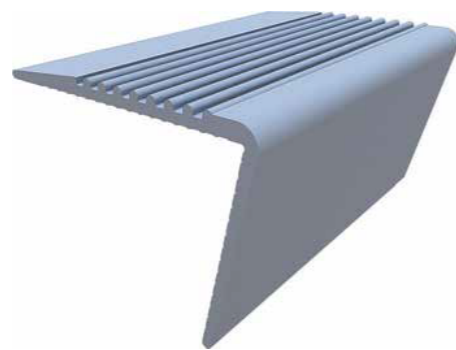
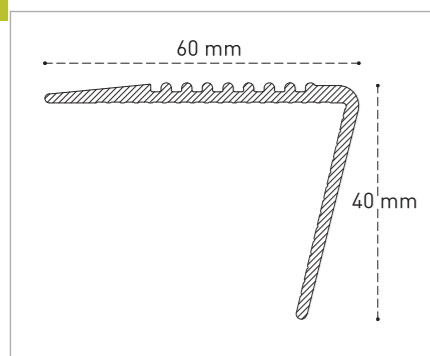

**SEPS 10S**

LOGISTIC DATA

Standard	Optionally
2,50 m /Roll	4 m /Length
50 m	80 m
1650 m	2400 m

**SEPS 20S**

LOGISTIC DATA

Standard	Optionally
2,50 m /Roll	4 m /Length
50 m	80 m
1650 m	2400 m

**SEPS 30S**

LOGISTIC DATA

Standard	Optionally
2,50 m /Roll	4 m /Length
50 m	80 m
1650 m	2400 m

**SEPS 40S**

LOGISTIC DATA

Standard	Optionally
2,50 m /Roll	4 m /Length
50 m	80 m
1650 m	2400 m

Chemical compounds suitable for the needs of the automotive industry are used in these products.

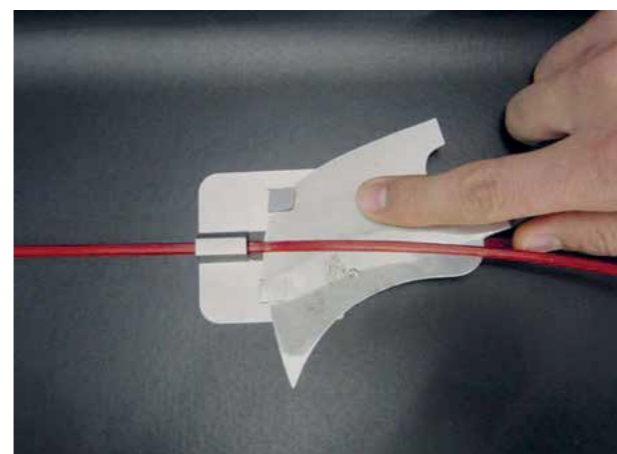
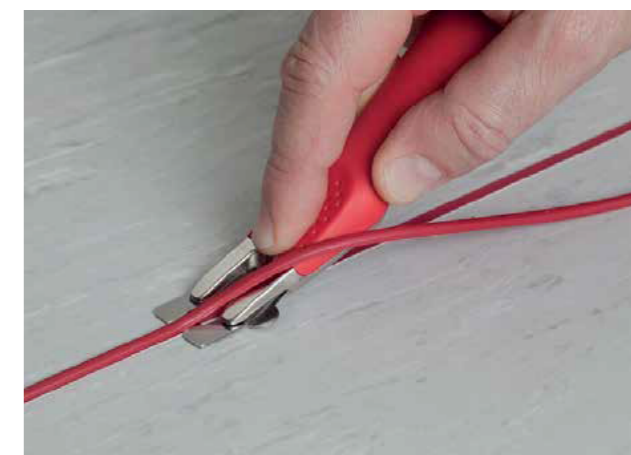
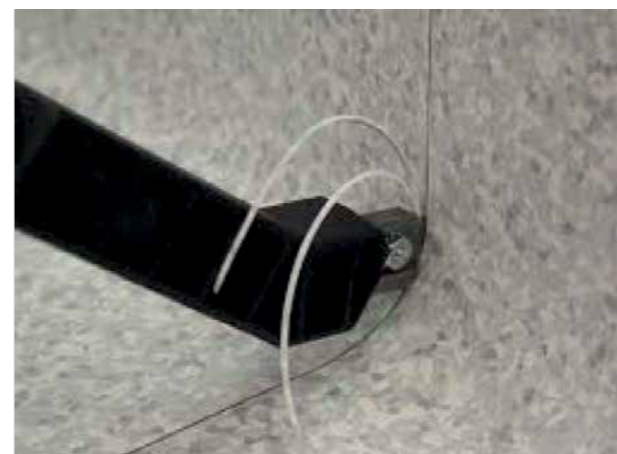

Hipokrat

EcoPrint

netflex

OTOKap  
EMBOSS

[N-LVT]

OTOKap  
EXTRA SOFT

SafeFlex

OTOKap  
EXTRA STRONG

DigiKap

ECOKap

HomeFlex

PopFlex

YERKop

PopFlex  
Lite

EcoFlex

PopFlex  
Ultra

EVKop

PopFlex  
Extra

BUSKop

PROKop

OTOKap  
PRINT

net finishing  
profiles



net  
FLOOR COVERINGS  
www.netfloor.com.tr



## Floor Coverings • Zemin Kaplamaları • Напольные покрытия

### NET ZEMİN KAPLAMALARI SAN. VE TİC. AŞ.

#### Satış Ofis / Sales Office

Bahar Cad. No:43 Nurolpark Ofis J Blok  
Kat:15 No:98 Güneşli  
Bağcılar / İSTANBUL - TURKEY

#### Finans - Muhasebe / Financial Accounting

Bahçeşehir 1. Kısım Mah. Üveyik Sok.  
Akasya 17 Sit. 1702A Apt. No:54  
Başakşehir / İSTANBUL - TURKEY

#### Merkez-Fabrika / Headquarter - Factory

Veliköy Mah. Sanayi Bulvarı  
No: 19/IA Çerkezköy  
TEKİRDAĞ / TURKEY

Tel: +90 212 886 53 35 (Pbx) - Faks: +90 212 886 52 09 - e-mail : info@netfloor.com.tr

**net**  
FLOOR COVERINGS  
www.netfloor.com.tr